



PRODUCT SHEET

Cylinder 60

Art. no: 60327-25-2



Lighting Solutions

Cylinder 60

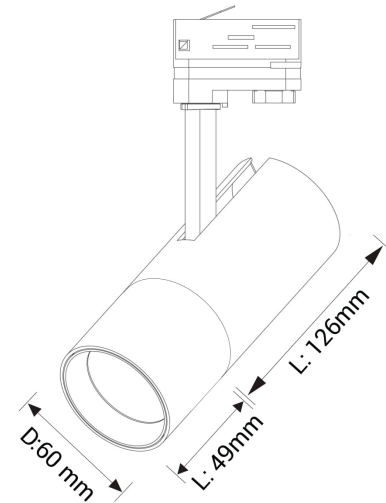

SPECIFICATIONS

Lightsource Type:	LED (built in)
System Power [W]:	14W
CCT (Color Temperature):	2700K
CRI / Ra:	90
Lumen LED (tc=25):	1450lm
Beam Angle:	25°
Lens (Diffuser):	Clear
Dimming:	Phase-Cut
System Voltage [V]:	230V 50Hz
Connection:	Track 3-Circuit
Mounting:	Ceiling, Track
Lifetime [h]:	L80B10: 60 000h
MacAdam (SDCM):	3
Color:	Black
Height [mm]:	220mm
Width [mm]:	60mm
Weight [kg]:	0,6kg

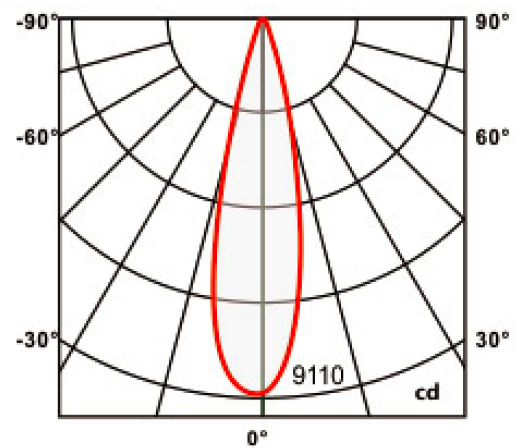

The Cylinder 60 has the LED driver included in the lamp head and is available for use in 1-circuit and 3-circuit tracks, both models are available with a Dim to Warm option. It can be tilted 90 degrees and rotated 350 degrees on its own axis and comes with a variety of accessories.