



FDV SPEC SHEET

Cylinder 60

Art. no: 60327-7-25-2



Lighting Solutions

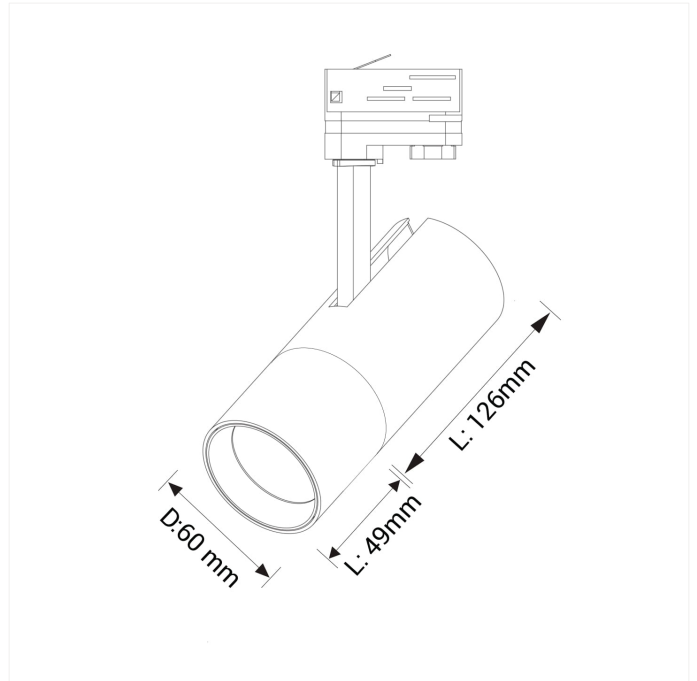

Cylinder 60



Art. no: 60327-7-25-2

LIGHT TECHNICAL

Lightsource Type:	LED (built in)
Lumen LED (tc=25):	1550
Beam Angle:	25°
CCT (Color Temperature):	2700
CRI / Ra:	90
Color Code:	927
Lens (Diffuser):	Clear

MOUNTING / CONNECTION

Connection:	Track 3-Circuit
Mounting:	Ceiling, Track

PRODUCT

Ingress Protection:	IP20
Operating Temperature [°C]:	-
Lifetime [h]:	L80B10: 60 000
Color:	Black
Height [mm]:	220
Width [mm]:	60
Weight [kg]:	0,6

ELECTRICAL DATA

Dimming:	Phase-Cut
System Power [W]:	14
System Voltage [V]:	230V 50Hz
Protection Class:	1
Max load pr circuit - B10:	50
Max load pr circuit - B16:	80
Max load pr circuit - C10:	50
Max load pr circuit - C16:	80
Inrush current time [µs]:	40
Socket / Cap-Base:	N/A
Current Output [mA]:	350