

# LCV 100W 24V 1-4CH DALI SR

## LED Driver Constant Voltage 24V DALI-2 1-4 channels



### Highlights

- Independent digital dimmable LED-driver for constant voltage 24 VDC
- Supports DALI-2 specification (IEC 62386-207:2018)
- Select between 1-4 addressable DALI channels
- DALI-address can easily be set with integrated display (no programming needed)
- Optimal for Tunable White, RGB and RGBW applications
- High resolution dimming range 0.1 – 100 %
- Max. output power 100 W (24 VDC)
- Typ. efficiency > 90 %
- Nominal life-time up to 50,000 h
- 5-year warranty

### Applications

- General Lighting
- Linear Lighting
- Accent Lighting
- Furniture Lighting

### Housing

- Polycarbonate White/Cyan
- Built-in strain relief on primary side
- Screw Terminals 0.5 - 2.5 mm<sup>2</sup>
- Integrated DALI-address selector and display
- Type of protection IP20

### Technical data

Rated supply voltage, AC Ⓢ	100 – 240 VAC
AC voltage range	90 – 277 VAC
Mains frequency	47 – 63 Hz
Typ. current (at 230 V, 50 Hz, full load)	500 mA
Max input power	115 W
Typ. efficiency (at 230 V / 50 Hz / full load) Ⓢ	90%
λ (at 230 V, 50 Hz, full load)	0,985
Typ. power input on stand-by Ⓢ	3,4 W
Typ. input current in no-load operation	29 mA
In-rush current (peak / duration)	80 A / μs
Mains surge capability (between L – N)	2 kV
THD (at 230 V, 50 Hz, full load)	< 10 %
Time to light (at 230 V, 50 Hz, full load)	< 2 s
Turn off time (at 230 V, 50 Hz, full load)	< 0,8 s
Output voltage tolerance	0,5 VDC
Output LF voltage ripple (< 120 Hz)	3 %
Max. output voltage (no-load voltage)	24,6 VDC
Dimming frequency (PWM)	500 Hz
No of dimming channels Ⓢ	1 – 4 (selectable)
Max Load per dim channel	1,05 – 4,16 A
Min Load per driver	0,2 A
Asymmetric load permitted	Yes
No-load operation permitted	Yes
Dimming range	0.1 – 100 %
Selectable Dimming Curve in DALI-mode Ⓢ	Logarithmic / Linear
DALI Short Addresses Ⓢ	1 – 4
DALI Current Draw	2 mA
DALI Device Type	6
Ambient temperature, ta	-20...+45 °C
Max. casing temperature, tc	75 °C
Humidity	20 – 90 %
Storage temperature	-40...+80 °C
Weight	440 g
Dimensions LxWxH	244 x 64 x 32 mm

Ⓢ Valid at 100 % dimming level  
 Ⓢ Depending on the DALI traffic at the interface  
 Ⓢ Operating outside the supply voltage window leads to an overload of the driver. This may result in a significant reduction in lifetime or even destruction of the dimmer.  
 Ⓢ Default setting 4 channels/addresses. To change settings, see p. 3.  
 Ⓢ Default setting Logarithmic. Can be changed to Linear with Tridonic masterCONFIGURATOR software



### Standards

→ page 2

### Dimming Control Interfaces

- DALI-2 DT6 (according to EN 62386-207:2018)
- 1-4 individually addressable DALI short addresses
- Selectable dimming curve – logarithmic (default) or linear

→ page 2

### Manual & Installation Guidelines

→ page 3

### Ordering data

Type	Article code	Packaging Carton	Packaging Pallet
LCV 100W 24V 1-4CH DALI SR	W7101	20	200

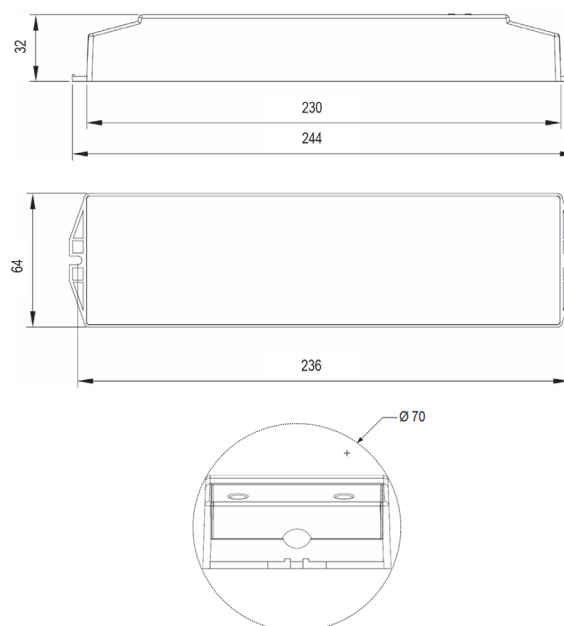

## Standards

- EN 55015
- EN 61000-3-2
- EN 61000-3-3
- EN 61347-1
- EN 61347-2-13
- EN 61547
- EN 62386-101
- EN 62386-102
- EN 62386-207

## Thermal behaviour

Storage Temperature	-30/+80 °C
Operating Temperature	-30/+45 °C
Tc max	75 °C

## Life-time

Ambient Temperature (Ta)	Reference Temperature (Tc)	Life-time
25 °C	55 °C	> 80,000 h
30 °C	60 °C	> 70,000 h
35 °C	65 °C	> 60,000 h
45 °C	75 °C	50,000 h

The LED Driver is designed for a life-time stated above under reference conditions and with a failure probability of less than 10 %. The relation of tc to ta temperature depends on the installation conditions.

**⚠ The temperature on the reference point of the LED Driver (tc) may under no circumstances be higher than 75 °C if the expected lifetime of the dimmer is to be met.**



Compliance with the maximum permissible reference temperature at the tc point must be checked under operating conditions in a thermally stable state. The maximum value must be determined under worst-case conditions for the relevant application.

## Dimming

### DIMMING CHARACTERISTICS

Dimming curve is adapted to the eye sensitiveness when logarithmic dimming curve is selected. Dimming is realized by pulse width modulation dimming (500 Hz).

	Programmable range (16 bit)	Default Value
Speed Min – Max	0.2 – 90 s	3 s
Min Level	0.1 – 100 %	1 %
Max Level	100 – 1 %	100 %

The LED Driver supports both logarithmic and linear dimming curves. The default setting is logarithmic. The dimming curve can be changed using Tridonic ([www.tridonic.com](http://www.tridonic.com)) DALI-USB programmer and the software masterCONFIGURATOR.

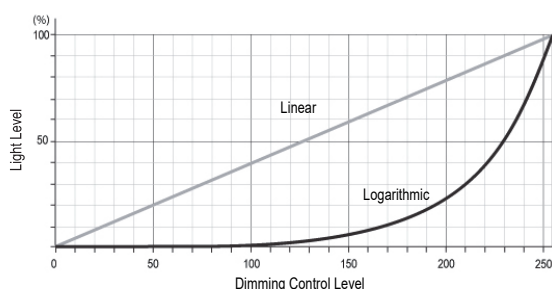

## DALI

Digital DALI signal should be wired on the terminals DA and DA. The DALI-terminals are located on the secondary side (right) on production batch <1134 and on the primary side (left) on batch ≥1134. The control input is non-polar. The control signal is not SELV. Control cable must be installed in accordance to the requirements of low voltage installations.

With appropriate DALI-software and a programming interface the DALI channels can be addressed and various parameters can be configured in the LED Driver. Weight recommend using Tridonic ([www.tridonic.com](http://www.tridonic.com)) DALI-USB programmer and the software masterCONFIGURATOR. The LED Driver is recognized as a DALI Device Type 6 per the DALI-2 Standard (DT8 is available on request).

## TUNABLE WHITE DIMMING - DALI DT6 VS. DT8

The optimal way to control tunable white LED is with a DALI DT8 compatible driver. The W7101 can be ordered with DT8 compliance – please contact us at [info@weight.se](mailto:info@weight.se) for further information.

The standard version of W7101 is DALI-2 DT6 compliant. A DT6 driver can also be used to control tunable white LED, but there are some important points to consider:

- The dimmer will use two DALI-addresses - one for each white colour. See p. 3 for details on selecting the Tunable White Operation Mode.
- We recommend that the dimming mode is changed from logarithmic (factory default) to linear. This can be done via the masterCONFIGURATOR software available as free download from [www.tridonic.com](http://www.tridonic.com).
- A linear dimming curve is recommended to allow a user-friendly implementation of tunable white control. In a tunable white application, the secondary dimming channels are connected to the cool white (CW) and warm white (WW) LED:s respectively. By setting a unique dimming value of each channel (address), a white colour between the cool white and the warm white correlated colour temperature can be reached.
- Use your DALI control system to save the required colour temperature as scenes to ensure an easy way to recall fixed colour temperatures from the system, e.g. to create human centric lighting curves over time.
- A linear dimming curve also ensures that a DALI dim-up and dim-down command sent to the dimmer results in a lower light level within the already selected colour temperature (scene).

Using the LED Dimmer together with Weight LEDtape Tunable White any colour temperature between 2000 K and 6500 K can be generated via DALI.

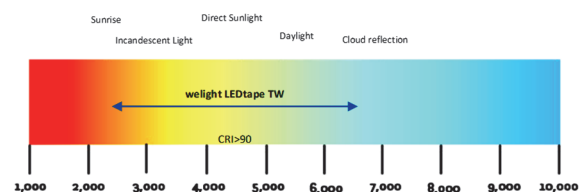

## Electrical Protection & Troubleshooting

### NO-LOAD OPERATION

The LED Driver will not be damaged in no-load operation. The output will be deactivated and is therefore free of voltage. If a LED load is connected the device must be restarted before the output will be activated again.

### SHORT-CIRCUIT BEHAVIOUR

In case of a short-circuit at the LED output the LED is switched off. After restart of the LED Driver the output will be activated again. The restart can either be done via supply voltage reset or DALI.

### VOLTAGE PROTECTION

If the supply voltage range is outside the range 100-240 VAC the LED Driver turns off the LED output. After restart of the LED Driver the output will be activated again. The restart can either be done via supply voltage reset or DALI.

### OVERLOAD PROTECTION

If the connected load per channel is > 4,16 A and/or the total load per driver is < 0.2 A or > 4,16 A the LED Driver turns off the LED output. After restart of the LED Driver the output will be activated again. The restart can either be done via supply voltage reset or DALI.

### OVERTEMPERATURE PROTECTION

The LED Driver is protected against temporary thermal overheating. If the temperature limit is exceeded the LED module(s) are dimmed to reduce operating temperature. The temperature protection is activated approx. +5 °C above tc max.

## Manual & Installation Guidelines

### SINGLE COLOUR – 1 Channel Operation

In single channel operation, all LED-outputs will be assigned the identical DALI-address, i.e. the entire driver will only take use one DALI address on the bus.

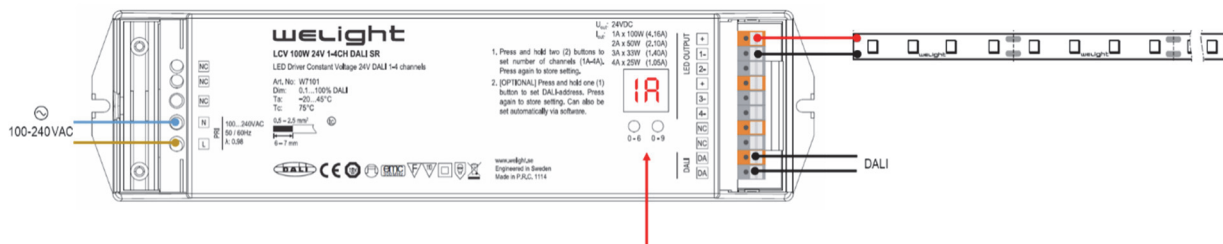

On later models (production batch  $\geq 1134$ ) the DALI terminals are located on the primary side (left):

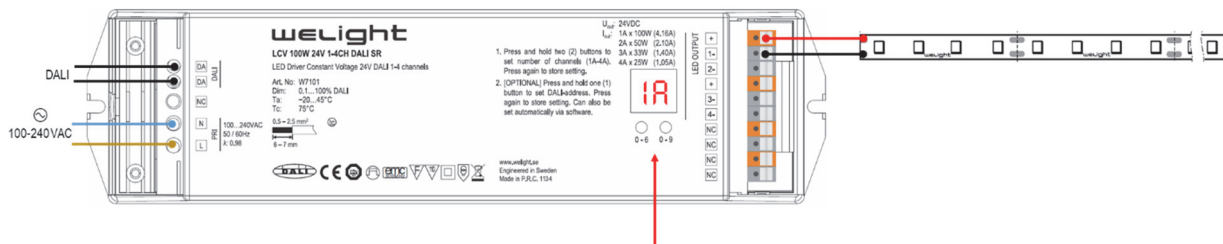

### SELECTING SINGLE COLOUR MODE

1. Make sure the driver is connected to mains supply. Press and hold the two buttons below the digital display simultaneously until the display starts flashing then release the buttons.

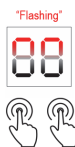

2. Click on the left button until 1A is shown in the display.



3. Press and hold down any button until the display stops flashing to store the setting into the driver.



### TUNABLE WHITE – 2 Channel Operation

In two channel operation, LED-outputs 1 + 3 and 2 + 4 will be assigned the identical DALI-address, i.e. the entire driver will use two DALI addresses on the bus.

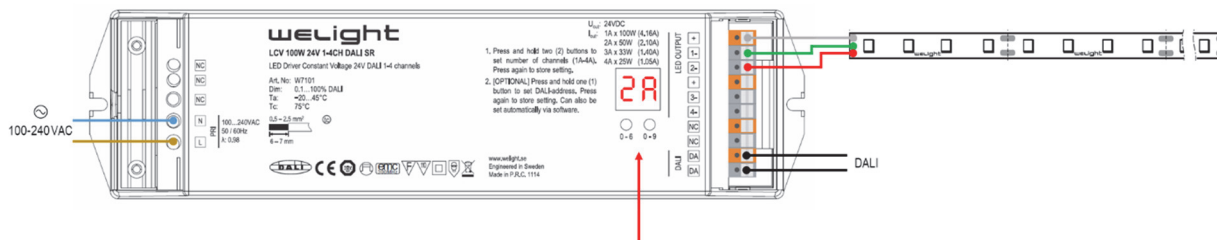

On later models (production batch  $\geq 1134$ ) the DALI terminals are located on the primary side (left):

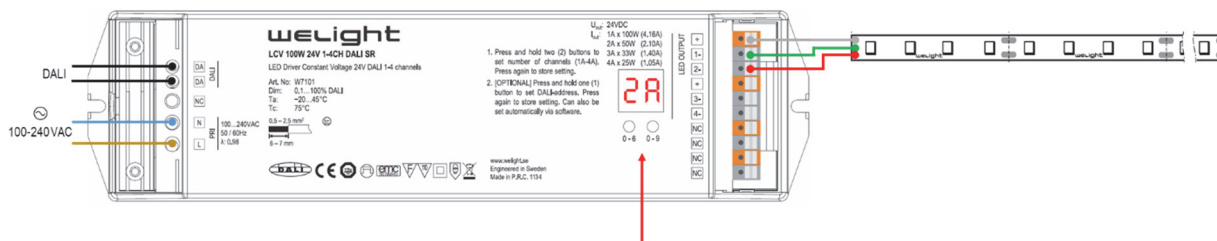

## SELECTING TUNABLE WHITE MODE

1. Make sure the driver is connected to mains supply. Press and hold the two buttons below the digital display simultaneously until the display starts flashing then release the buttons.



2. Click on the left button until 2A is shown in the display.



3. Press and hold down any button until the display stops flashing to store the setting into the driver.



## RGB – 3 Channel Operation

In three channel operation, LED-outputs 1, 2 and 3 will be assigned individual DALI-addresses and channel 4 will be assigned the same address as channel 3, i.e. the entire driver will use three DALI addresses on the bus.

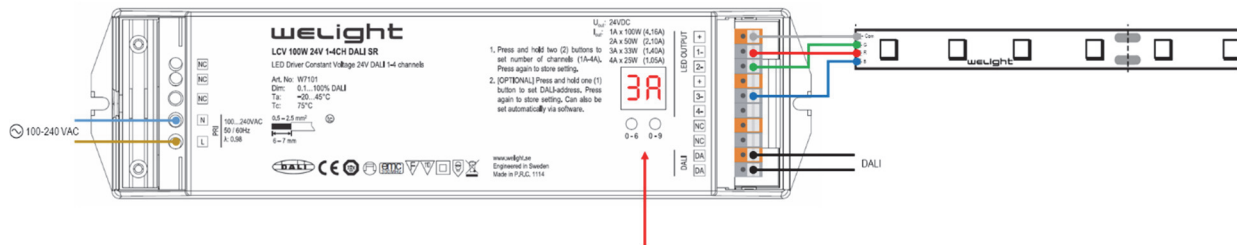

On later models (production batch  $\geq 1134$ ) the DALI terminals are located on the primary side (left):

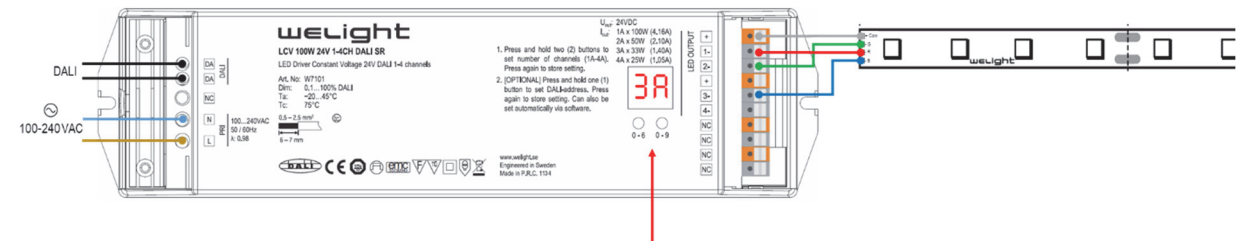

## SELECTING RGB MODE

1. Make sure the driver is connected to mains supply. Press and hold the two buttons below the digital display simultaneously until the display starts flashing then release the buttons.



2. Click on the left button until 3A is shown in the display.



3. Press and hold down any button until the display stops flashing to store the setting into the driver.



**RGB – 4 Channel Operation [Factory Default]**

In four channel operation, LED-outputs 1, 2, 3 and 4 will be assigned individual DALI-addresses, i.e. the entire driver will use four DALI addresses on the bus. This is the factory default mode, i.e. if you intend to use the driver with four channel operation, please jump directly to section <Setting the DALI-address> below.

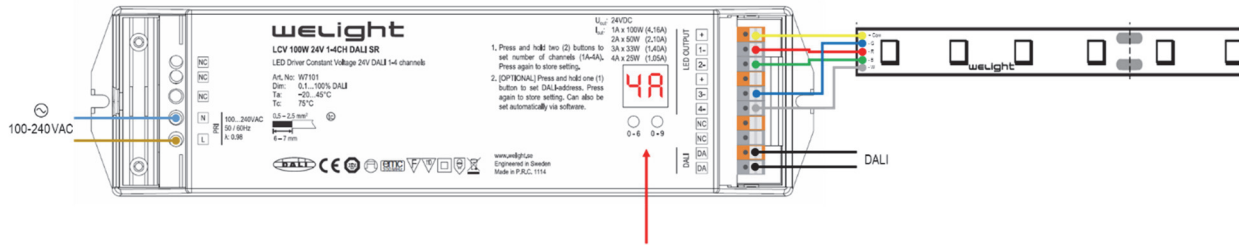

On later models (production batch ≥1134) the DALI terminals are located on the primary side (left):

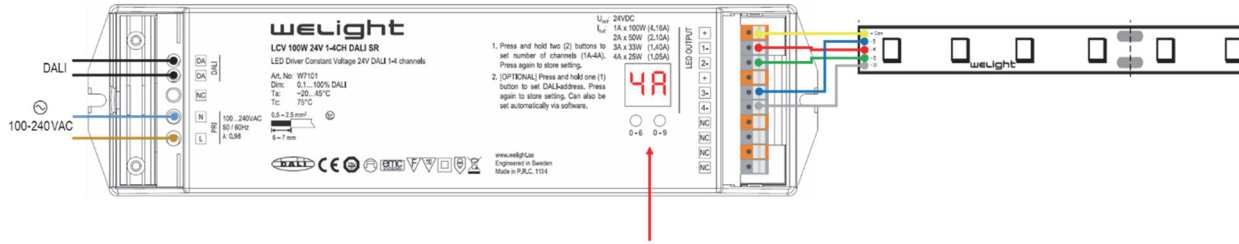

**SELECTING RGB MODE**

1. Make sure the driver is connected to mains supply. Press and hold the two buttons below the digital display simultaneously until the display starts flashing then release the buttons.



2. Click on the left button until 4A is shown in the display.



3. Press and hold down any button until the display stops flashing to store the setting into the driver.



**Setting the DALI-address**

If you want to set the DALI-address via software, please refer to your DALI-software manual to set the DALI-address of the driver, e.g. Tridonic masterCONFIGURATOR software available from tridonic.com.

**⚠** The LED driver supports DALI broadcast out-of-the-box, i.e. if you intend to use DALI broadcast you can skip these steps entirely. In DALI BC mode, all channels 1-4 will respond identical to any DALI command broadcasted on the bus.

If you want to set the DALI-address manually, please follow the instructions below. The address can be set to any number between 01-64. The selected DALI-address (A) will determine the sequential addresses of the other channels, i.e. if the address is set to 25, the second address will automatically be 26, the third 27, etc. After completing the programming, the output channels will respond to the DALI-address as per the table below:



MODE	DALI Address	Output 1	Output 2	Output 3	Output 4
Broadcast	BC	BC	BC	BC	BC
Single Colour	A	A	A	A	A
Tunable White	A	A	A + 1	A	A + 1
RGB	A	A	A + 1	A + 2	A + 2
RGBW	A	A	A + 1	A + 2	A + 3

A = 01-64

1. Make sure the driver is connected to mains supply. Press and hold the left button below until the display starts flashing then release the button.



- Click on the left button to set the first digit (ten position) in the DALI-address, i.e. any number from 0-6.

Example; to set the DALI-address 25, click the left button until the digit 2 is shown in the display.



- Click on the right button to set the second position in the DALI-address, i.e. any number from 0-9.

Example; to set the DALI-address 25, click the right button until the digit 5 is shown in the display.



- Press and hold down any button until the display stops flashing to store the setting into the driver.



### Range and asymmetric load

The LED Driver supports asymmetric load between channel 1-4 on the secondary side if the total load per driver is  $\geq 0.2$  A and  $\leq 4,16$  A.

### Wire type and cross section

Stranded wire or solid wire up to 2.5 mm<sup>2</sup> may be used for wiring. Strip 6-7 mm of insulation from the cables to ensure perfect operation of the push terminals. Use one wire for each terminal connector only. For the strain relief to work properly the outer dimension of the cable should be between 7 – 12 mm. The LED wiring should be kept as short as possible to ensure good EMC. If the secondary cable length is longer than 2 m (4 m circuit), it is recommended to use a screened cable type, e.g. LiYCY 2 x 2.5 mm<sup>2</sup>.

### Calculating Voltage Drop

When calculating the recommended cable area for your low-voltage connections the maximum permitted voltage drop is 1 V. Please make sure you consider the total length, i.e. including the length of your LED-strip in your voltage drop calculation.

### Secondary switching & Hot plug-in

Secondary switching and hot plug-in is not allowed due to the risk of arching effects on the secondary side which can lead to malfunction or irreparable damage.

### Maximum loading of automatic circuit breakers

Type	C10	C13	C16	C20
Max no of Drivers	16	20	26	32