



FDV SPEC SHEET

Colonel
Art. no: 3911-03-2



Lighting Solutions

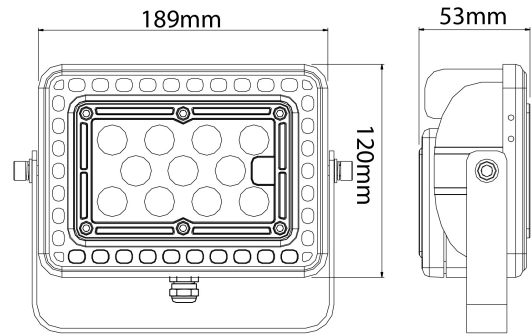

Colonel



Art. no: 3911-03-2

LIGHT TECHNICAL

Lumen Output:	3756
Lumen LED (tc=25):	4700
Beam Angle:	110x90°
CCT (Color Temperature):	4000
CRI / Ra:	80
Color Code:	840
Lens (Diffuser):	Clear

MOUNTING / CONNECTION

Connection:	Cable 0.5m
Mounting:	Surface, Wall, Ceiling, Floor

ELECTRICAL DATA

Dimming:	1-10V
System Power [W]:	29
System Voltage [V]:	230V 50Hz
Protection Class:	1
Max load pr circuit - B10:	7
Max load pr circuit - B16:	11
Max load pr circuit - C10:	8
Max load pr circuit - C16:	13
Leakage current [mA]:	1
Inrush current I _{max} [A]:	50
Inrush current time [µs]:	5
Socket / Cap-Base:	N/A



FDV SPEC SHEET

Colonel

Art. no: 3911-03-2



Lighting Solutions

PRODUCT

Ingress Protection:	IP66
Impact Protection:	IK10
Operating Temperature [°C]:	-40 - 55
Lifetime [h]:	L80B50: 50 000
Color:	Black/Brown
Length [mm]:	189
Height [mm]:	120
Width [mm]:	53
Weight [kg]:	1,2