



## FDV SPEC SHEET

Cylinder 60  
Art. no: 601DC-38-2



Lighting Solutions

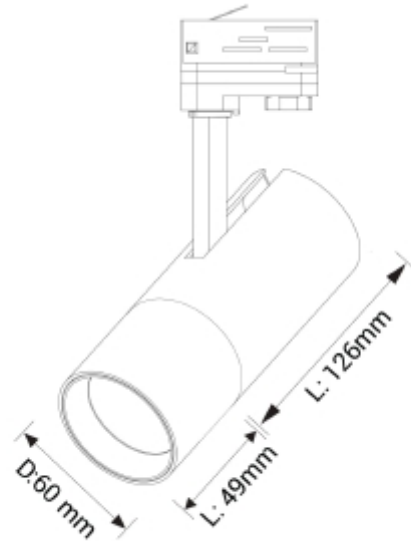

# Cylinder 60



Art. no: 601DC-38-2

### LIGHT TECHNICAL

Lightsource Type:	LED (built in)
Lumen LED (tc=25):	1100
Beam Angle:	38°
CCT (Color Temperature):	3000-2000K D2W
CRI / Ra:	95
Color Code:	930
Lens (Diffuser):	Clear

### MOUNTING / CONNECTION

Connection:	Track 1-Circuit
Mounting:	Track, Ceiling

### PRODUCT

Ingress Protection:	IP20
Lifetime [h]:	L80B10: 60 000
Color:	Black
Height [mm]:	220
Width [mm]:	60
Weight [kg]:	0,6

### ELECTRICAL DATA

Dimming:	Phase-Cut
System Power [W]:	15
System Voltage [V]:	230V 50Hz
Dimming Output Type:	Amplitude Modulation
Dimming Phasecut Type:	Leading / Trailing edge
Protection Class:	1
Max load pr circuit - B10:	50
Max load pr circuit - B16:	80
Max load pr circuit - C10:	50
Max load pr circuit - C16:	80
Inrush current time [µs]:	40
Socket / Cap-Base:	N/A
Current Output [mA]:	350
Dimming Output Type:	Amplitude Modulation
Dimming Phasecut Type:	Leading / Trailing edge