



FDV SPEC SHEET

Cylinder 60

Art. no: 60330-7-02-38-3



Lighting Solutions

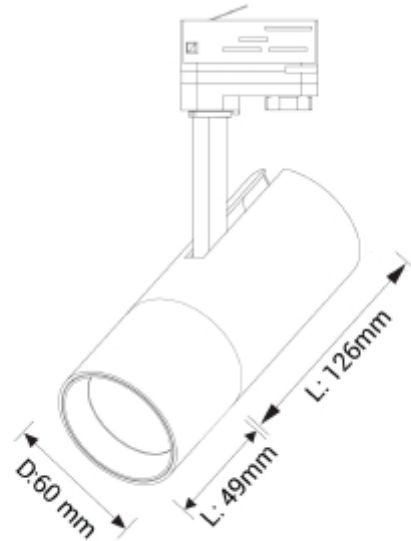

Cylinder 60



Art. no: 60330-7-02-38-3

LIGHT TECHNICAL

Lightsource Type:	LED (built in)
Lumen LED (tc=25):	1600
Beam Angle:	38° (15° & 25°)
CCT (Color Temperature):	3000
CRI / Ra:	90
Color Code:	930
Lens (Diffuser):	Clear

MOUNTING / CONNECTION

Connection:	Track 3-Circuit
Mounting:	Track, Ceiling

PRODUCT

Ingress Protection:	IP20
Lifetime [h]:	L80B10: 60 000
Color:	White
Height [mm]:	220
Width [mm]:	60
Weight [kg]:	0,6

ELECTRICAL DATA

Dimming:	Phase-Cut
System Power [W]:	14
System Voltage [V]:	230V 50Hz
Dimming Output Type:	Amplitude Modulation
Dimming Phasecut Type:	Leading / Trailing edge
Protection Class:	1
Max load pr circuit - B10:	35
Max load pr circuit - B16:	56
Max load pr circuit - C10:	74
Max load pr circuit - C16:	118
Inrush current time [µs]:	40
Socket / Cap-Base:	N/A
Current Output [mA]:	350
Dimming Output Type:	Amplitude Modulation
Dimming Phasecut Type:	Leading / Trailing edge