



## PRODUCT SHEET

Cylinder 60

Art. no: 60330-7-02-38-3



Lighting Solutions

# Cylinder 60

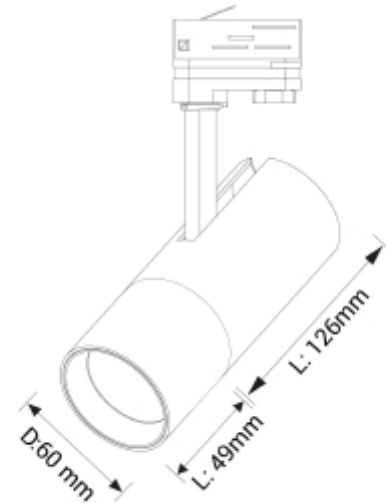

SPECIFICATIONS	
Lightsource Type:	LED (built in)
System Power [W]:	14W
CCT (Color Temperature):	3000K
CRI / Ra:	90
Lumen LED (tc=25):	1600lm
Beam Angle:	38° (15° & 25°)
Lens (Diffuser):	Clear
Dimming:	Phase-Cut
System Voltage [V]:	230V 50Hz
Connection:	Track 3-Circuit
Mounting:	Track, Ceiling
Lifetime [h]:	L80B10: 60 000h
Color:	White
Height [mm]:	220mm
Width [mm]:	60mm
Weight [kg]:	0,6kg

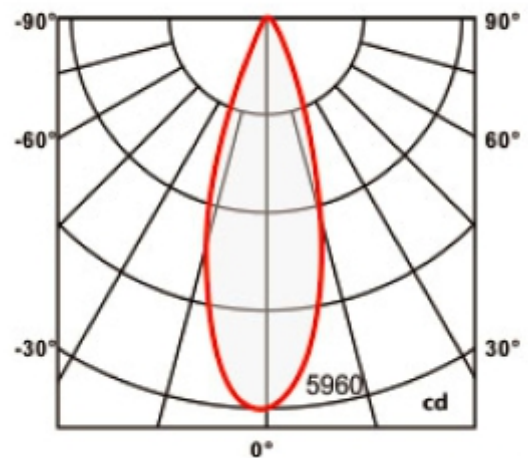

The Cylinder 60 has the LED driver included in the lamp head and is available for use in 1-circuit and 3-circuit tracks, both models are available with a Dim to Warm option. It can be tilted 90 degrees and rotated 350 degrees on its own axis and comes with a variety of accessories.