



FDV SPEC SHEET

Auriga

Art. no: 738-2-40-3



Lighting Solutions

176mm

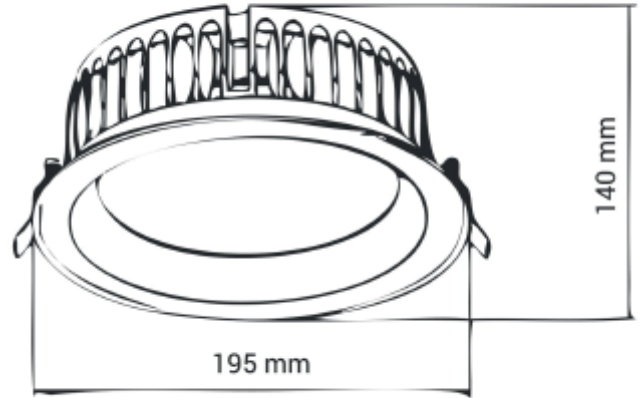

Auriga

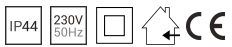

Art. no: 738-2-40-3

LIGHT TECHNICAL

Lightsource Type:	LED (built in)
Lumen Output:	2990
Lumen LED (tc=25):	2990
Beam Angle:	40°
CCT (Color Temperature):	4000
CRI / Ra:	80
Color Code:	840
Lens (Diffuser):	Clear

MOUNTING / CONNECTION

Cut-out [mm]:	Ø176
Mounting:	Recessed

ELECTRICAL DATA

Dimming:	None
System Power [W]:	28
System Voltage [V]:	230V 50Hz
Protection Class:	2
Max load pr circuit - B10:	27
Max load pr circuit - B16:	44
Max load pr circuit - C10:	45
Max load pr circuit - C16:	74
Inrush current I _{max} [A]:	7
Inrush current time [µs]:	25
Socket / Cap-Base:	N/A
Current Output [mA]:	500



FDV SPEC SHEET

Auriga

Art. no: 738-2-40-3



Lighting Solutions

PRODUCT

To be recessed in insulation:	No
Ingress Protection:	IP44
Impact Protection:	IK05
Operating Temperature [°C]:	35 -
Lifetime [h]:	L80B10: 100 000
Color:	White
Height [mm]:	140
Width [mm]:	195