



PRODUCT SHEET

Ledline

Art. no: 805005-3



Lighting Solutions

Ledline

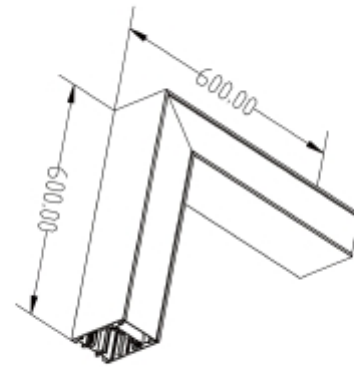
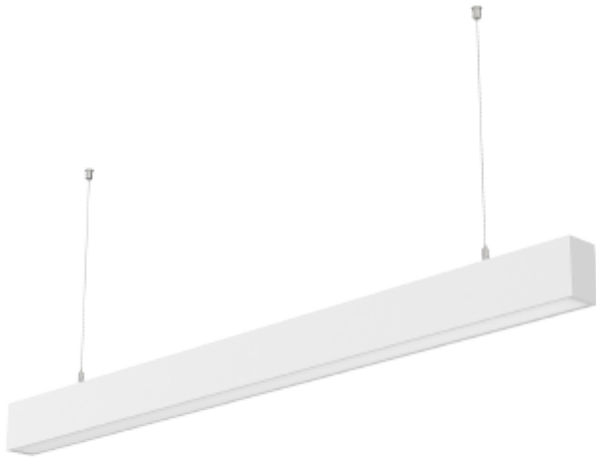

SPECIFICATIONS	
Lightsource Type:	LED (built in)
System Power [W]:	40W
CCT (Color Temperature):	3000K
CRI / Ra:	80
Lumen Output:	3650lm
Lumen LED (tc=25):	4400lm
Beam Angle:	110
Lens (Diffuser):	Opal
Dimming:	None
System Voltage [V]:	230V 50Hz
Connection:	LEDLine 5-pin
Mounting:	Recessed, Surface, Ceiling, Pendant
Lifetime [h]:	L70B50: 50 000h
Lumen/W:	92lm/W
Color:	White
Length [mm]:	600mm
Height [mm]:	84mm
Width [mm]:	600mm
Weight [kg]:	3,3kg

LEDline is a modern linear LED system for seamless lighting. It is based on modular chassis details allowing for seamless extensions through both straight connectors, 90 degrees corners and X-crosses. This allows light designers to make tailor fit lighting systems in an easy manner. The chassis details assure easy installation without failures. Add 1 pc 8050-05 for each mains supply (each row or standalone). Also add mounting accessories.