



FDV SPEC SHEET

Ceto Fixed

Art. no: 28830-TW-36-3-ddd



Lighting Solutions



92mm

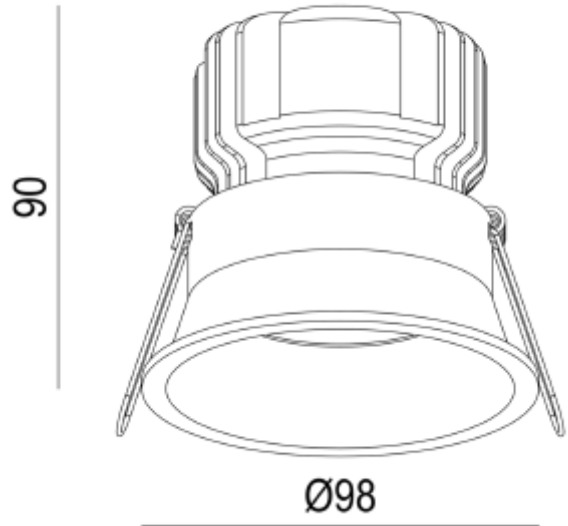

Ceto Fixed

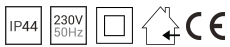

Art. no: 28830-TW-36-3-dd

LIGHT TECHNICAL

Lumen LED (tc=25):	900
Beam Angle:	36
CCT (Color Temperature):	6000-2700K TW
CRI / Ra:	80
Color Code:	827-860
MacAdam (SDCM):	3
Lens (Diffuser):	Clear

MOUNTING / CONNECTION

Connection:	QuickConnect
Cut-out [mm]:	Ø92
Mounting:	Recessed, Ceiling

ELECTRICAL DATA

Dimming:	DALI
Flicker metric (Pst LM) <:	1
Stroboscopic effect metric (SVM) <:	0,4
System Power [W]:	15
System Voltage [V]:	230V 50Hz
Protection Class:	2
Max load pr circuit - B10:	46
Max load pr circuit - B16:	74
Max load pr circuit - C10:	62
Max load pr circuit - C16:	100
Inrush current I _{max} [A]:	15
Inrush current time [µs]:	100
Socket / Cap-Base:	N/A
Voltage Forward Min [V]:	32,4
Voltage Forward Max [V]:	36



FDV SPEC SHEET

Ceto Fixed

Art. no: 28830-TW-36-3-ddd



Lighting Solutions

PRODUCT

To be recessed in insulation:	No
Ingress Protection:	IP44
Impact Protection:	IK02
Operating Temperature [°C]:	-20 - 45
Lifetime [h]:	L80B10: 100 000
Color:	White
Height [mm]:	90
Diameter [mm]:	98
Weight [kg]:	0,25