

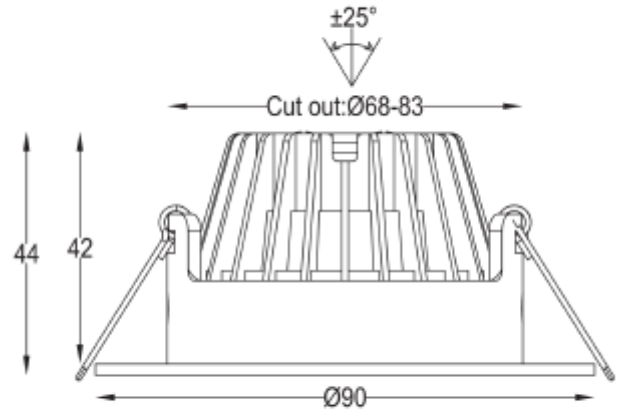

## FDV SPEC SHEET

Icarus 500lm 927 36° 7W BK phasecut Isosafe 8-pack  
Art. no: 101975-36-2

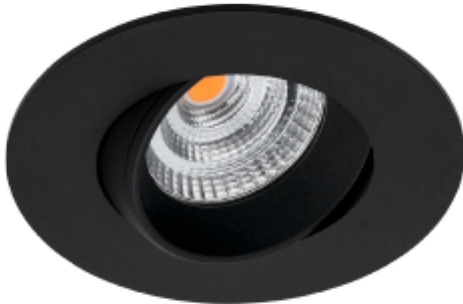

# Icarus 500lm 927 36° 7W BK phasecut Isosafe 8-pack

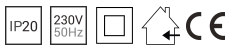

Art. no: 101975-36-2

### LIGHT TECHNICAL

Lightsource Type:	LED (built in)
Lumen Output:	456
Lumen LED (tc=25):	500
Beam Angle:	36°
CCT (Color Temperature):	2700
CRI / Ra:	95
Color Code:	927
MacAdam (SDCM):	3
Lens (Diffuser):	Clear



## FDV SPEC SHEET

Icarus 500lm 927 36° 7W BK phasecut Isosafe 8-pack  
Art. no: 101975-36-2



### MOUNTING / CONNECTION

Connection:	QuickConnect
Cut-out [mm]:	Ø68-83
Mounting:	Ceiling

### PRODUCT

To be recessed in insulation:	Yes, recessed in insulation
Ingress Protection:	IP20
Impact Protection:	IK02
Operating Temperature [°C]:	-20 - 45
Lifetime [h]:	L80B10: 100 000
Color:	Black
RAL:	RAL9005
Height [mm]:	44
Diameter [mm]:	90
Weight [kg]:	0,3
Housing Material :	Aluminium
Diffuser Material:	Polycarbonate
Material 2:	Polycarbonate
Housing Material :	Aluminium
Diffuser Material:	Polycarbonate
Material 2:	Polycarbonate

### ELECTRICAL DATA

UGR (<=):	22
Dimming:	Phase-Cut
Dimming Phasecut Type:	Leading / Trailing edge
Flickerfree:	Yes
Standby power P <sub>sb</sub> (W) <:	0,5
Flicker metric (P <sub>st</sub> LM) <:	1
Stroboscopic effect metric (SVM) <	0,4
System Power [W]:	7
System Voltage [V]:	230V 50Hz
Protection Class:	2
Max load pr circuit - B10:	87
Max load pr circuit - B16:	225
Max load pr circuit - C10:	175
Max load pr circuit - C16:	450
Leakage current [mA]:	5
Inrush current I <sub>max</sub> [A]:	8
Inrush current time [µs]:	13,5
Socket / Cap-Base:	N/A
Current Output [mA]:	350
Voltage Forward Min [V]:	13,4
Voltage Forward Max [V]:	15,8