



## FDV SPEC SHEET

Theros Lite  
Art. no: 101745-01-1



Lighting Solutions

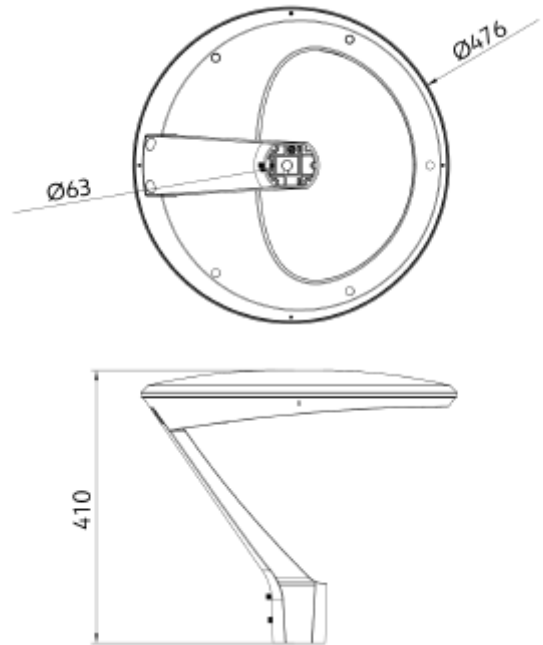

# Theros Lite



Art. no: 101745-01-1

### LIGHT TECHNICAL

Lumen Output:	3655
Lumen LED (tc=25):	4030
CCT (Color Temperature):	4000
CRI / Ra:	80
Color Code:	840

### MOUNTING / CONNECTION

Connection:	Cable 5m
Mounting:	Mast

### ELECTRICAL DATA

Dimming:	None
System Power [W]:	31
System Voltage [V]:	230V 50Hz
Protection Class:	1
Socket / Cap-Base:	N/A



## FDV SPEC SHEET

Theros Lite

Art. no: 101745-01-1



*Lighting Solutions*

### PRODUCT

Ingress Protection:	IP66
Impact Protection:	IK08
Wind force (EPA) [m2] at 0°:	0,15
Surge Protection:	L-N = 4KV, L/N-PE = 6KV
Operating Temperature [°C]:	-30 - 50
Lifetime [h]:	L80B50: 100 000
Color:	Grey
RAL:	RAL7022
Height [mm]:	410
Diameter [mm]:	476
Weight [kg]:	7,1