



FDV SPEC SHEET

Tania Mini Slim Basic
Art. no: 101921-36-3-p



Lighting Solutions

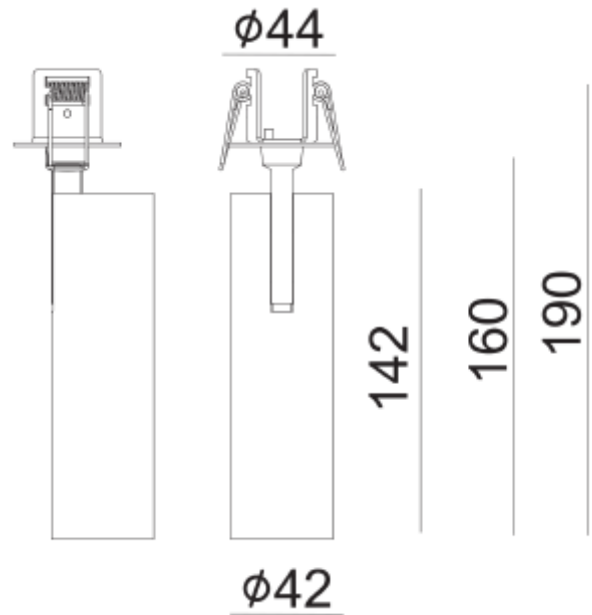

Tania Mini Slim Basic



Art. no: 101921-36-3-p

LIGHT TECHNICAL

Lightsource Type:	LED (built in)
Lumen Output:	764
Lumen LED (tc=25):	850
Beam Angle:	36°
CCT (Color Temperature):	3000
CRI / Ra:	90
Color Code:	930
MacAdam (SDCM):	3
Lens (Diffuser):	Clear

MOUNTING / CONNECTION

Connection:	Terminal
Cut-out [mm]:	Ø35
Mounting:	Recessed, Ceiling

ELECTRICAL DATA

Dimming:	Phase-Cut
Dimming Phasecut Type:	Trailing edge
Flicker metric (Pst LM) <:	1
Stroboscopic effect metric (SVM) <:	0,4
System Power [W]:	9
System Voltage [V]:	230V 50Hz
Protection Class:	2
Max load pr circuit - B10:	125
Max load pr circuit - B16:	200
Max load pr circuit - C10:	125
Max load pr circuit - C16:	200
Inrush current I _{max} [A]:	5
Inrush current time [µs]:	100
Voltage Forward Min [V]:	32,3
Voltage Forward Max [V]:	38,1



FDV SPEC SHEET

Tania Mini Slim Basic
Art. no: 101921-36-3-p



PRODUCT	
To be recessed in insulation:	Not applicable
Ingress Protection:	IP20
Operating Temperature [°C]:	-20 - 40
Lifetime [h]:	L80B10: 100 000
Color:	White
RAL:	RAL9003
Height [mm]:	142
Diameter [mm]:	42
Housing Material :	Aluminium