



## PRODUCT SHEET

Cold 10

Art. no: 1111-30-2

# NORLUX®

Lighting Solutions

## Cold 10



250x36mm

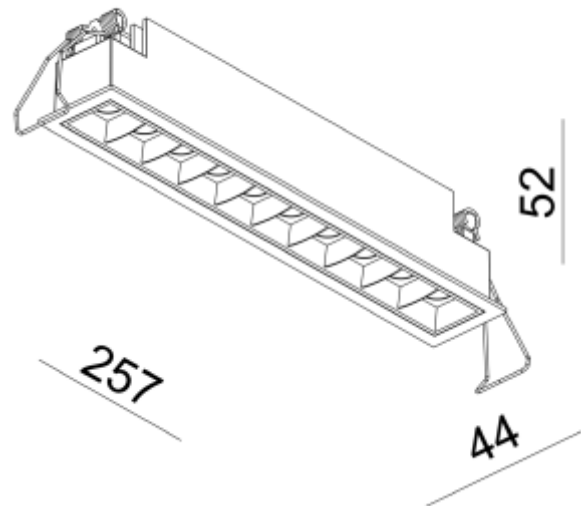

### SPECIFICATIONS

Lightsource Type:	LED (built in)
System Power [W]:	2x10W
CCT (Color Temperature):	3000K
CRI / Ra:	90
Lumen Output:	2150lm
Lumen LED (tc=25):	2200lm
Beam Angle:	30°
Lens (Diffuser):	None
Dimming:	Depending on Driver
Flickerfree:	Yes
System Voltage [V]:	230V 50Hz
Connection:	Depending on driver
Mounting:	Recessed, Ceiling
Cut-out [mm]:	250x36mm
Lifetime [h]:	L80B10: 100 000h
Lumen/W:	97lm/W
Color:	Black
Length [mm]:	257mm
Height [mm]:	52mm
Width [mm]:	44mm
Weight [kg]:	0,7kg
To be recessed in insulation:	No

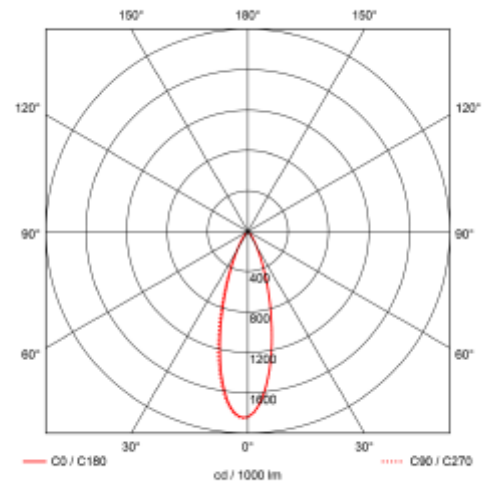

Med sin rektangulære form og inntrukket lyskilde har Cold downlight et unikt dekorativt design som egner seg i de fleste rom. Frontring leveres i flere farger og byttes enkelt ut. Driver medfølger ikke, se tilbehør for alternativ farge på front ring. DALI2: IE25D-03 Driver 350-700mA cc 25W DALI2 EPN0034 & 18i5DALI DALI2: 0300-17 Driver DALI 700mA max 35W 25-50V (one4all) 18i5 DALI/EPN0034 Fasekutt: D70030NTF-02 Driver 700mA cc 30W (21-43V) Phasecut JB&