



FDV SPEC SHEET

Cylinder 60

Art. no: 102261-36-3-p



Lighting Solutions

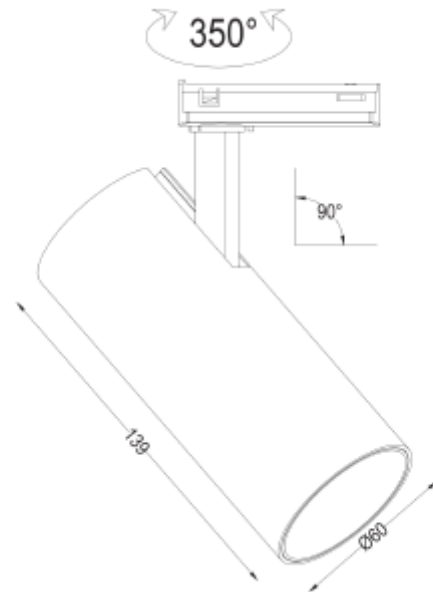

Cylinder 60



Art. no: 102261-36-3-p

LIGHT TECHNICAL

Lightsource Type:	LED (built in)
Lumen Output:	1400
Lumen LED (tc=25):	2100
Beam Angle:	36°
CCT (Color Temperature):	3000
CRI / Ra:	90
Color Code:	930
MacAdam (SDCM):	3
Lens (Diffuser):	Clear
UGR (<=):	19

MOUNTING / CONNECTION

Connection:	Track 3-Circuit
Mounting:	Track, Ceiling

ELECTRICAL DATA

Dimming:	Phase-Cut
Flickerfree:	Yes
System Power [W]:	15
System Voltage [V]:	230V 50Hz
Protection Class:	1
Socket / Cap-Base:	N/A
Current Output [mA]:	350
Voltage Forward Min [V]:	32
Voltage Forward Max [V]:	36,2
Emergency light [h]:	No Emergency light



FDV SPEC SHEET

Cylinder 60

Art. no: 102261-36-3-p



Lighting Solutions

PRODUCT

Ingress Protection:	IP20
Impact Protection:	IK02
Operating Temperature [°C]:	-20 - 45
Lifetime [h]:	L80B10: 100 000
Color:	White
RAL:	RAL9010
Length [mm]:	130
Height [mm]:	130
Diameter [mm]:	60
Weight [kg]:	0,42
Housing Material :	Aluminium
Diffuser Material:	Aluminium
Material 2:	Polycarbonate