



PRODUCT SHEET

Cylinder 70
Art. no: 17055-36-3



Lighting Solutions

Cylinder 70

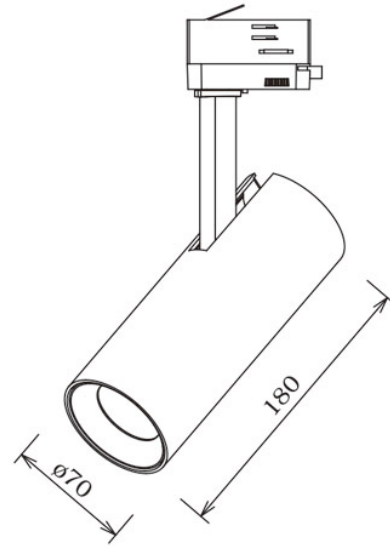

Luminous Intensity Distribution Curve

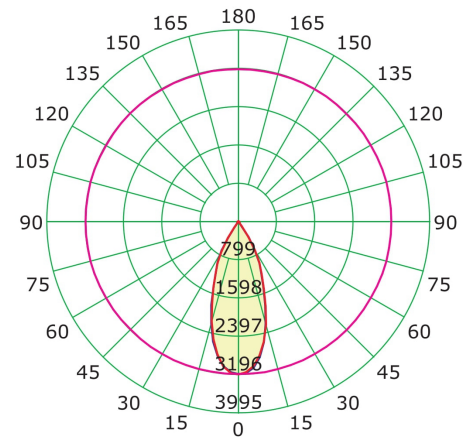

Unit: cd

— C0-C180 — C90-C270 — G0

The Cylinder uses the possibilities created by new technology. The LED driver is mounted inside the luminaire body. This gives us a slim design combined with a powerful light output that can be easily adjusted in all directions to meet all needs. Cylinder can be tilted 90 degrees and rotated 350 degrees its own axis. To create further opportunities to "play" with light you can mount a diffuser on the luminaire, this can be ordered separately.



SPECIFICATIONS

Lightsource Type:	LED (built in)
System Power [W]:	20W
CCT (Color Temperature):	3000K
CRI / Ra:	90
Lumen Output:	1676lm
Lumen LED (tc=25):	2350lm
Beam Angle:	36°
Lens (Diffuser):	Clear
Dimming:	None
System Voltage [V]:	230V 50Hz
Connection:	Track 3-Circuit
Mounting:	Ceiling, Track
UGR (<=):	21
Lumen/W:	84lm/W
MacAdam (SDCM):	3
Color:	White
Length [mm]:	180mm
Height [mm]:	225mm
Width [mm]:	70mm
Weight [kg]:	0,85kg