



PRODUCT SHEET

Ufo B High Bay 150W

Art. no: 4213-01-2



Lighting Solutions

Ufo B High Bay 150W

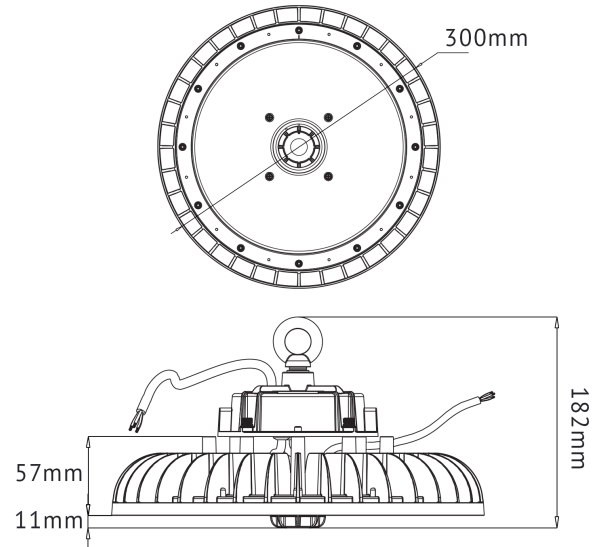

SPECIFICATIONS

Lightsource Type:	LED (built in)
System Power [W]:	150W
CCT (Color Temperature):	3000K
CRI / Ra:	80
Lumen Output:	23350lm
Lumen LED (tc=25):	25700lm
Beam Angle:	120
Lens (Diffuser):	Lens
Dimming:	1-10V, PWM
System Voltage [V]:	230V 50Hz
Connection:	18i3 5m + 2x0,4m free end
Mounting:	Suspended
Lifetime [h]:	L80B50: 76 000h
Lumen/W:	156lm/W
Color:	Black
Height [mm]:	116mm
Width [mm]:	300mm
Weight [kg]:	2,65kg

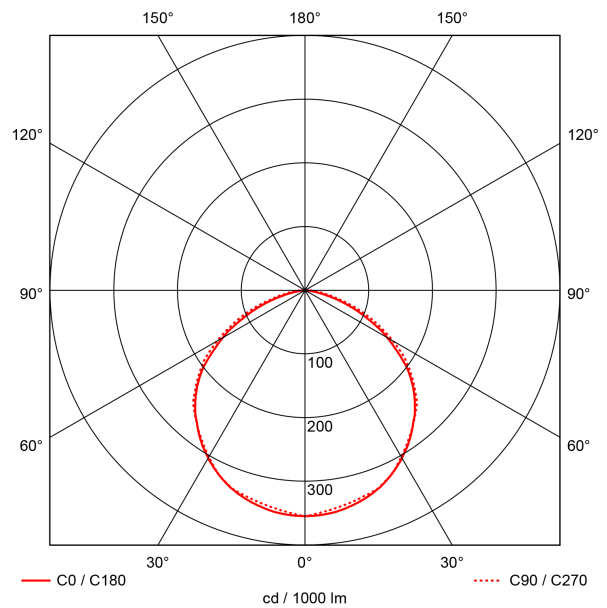

Ufo B high bay is absolute top-notch concerning light output and mechanical strength. The luminaire is classified accordance to the IP65 norm. This makes UFO B very suitable for use in tough conditions. The light output from the UFO B is >160 lm/W, makes this a perfect choice. Add a PIR or microwave sensor to make your light control more cost efficient. Sensor can not be used together with DALI2 version. Ufo B high Bay are delivered with 1-10V / PWM dimming or DALI2. See accessories for variable choice of lampshade and lenses.