



FDV SPEC SHEET

Ufo B High Bay 150W

Art. no: 4214-02-2



Lighting Solutions

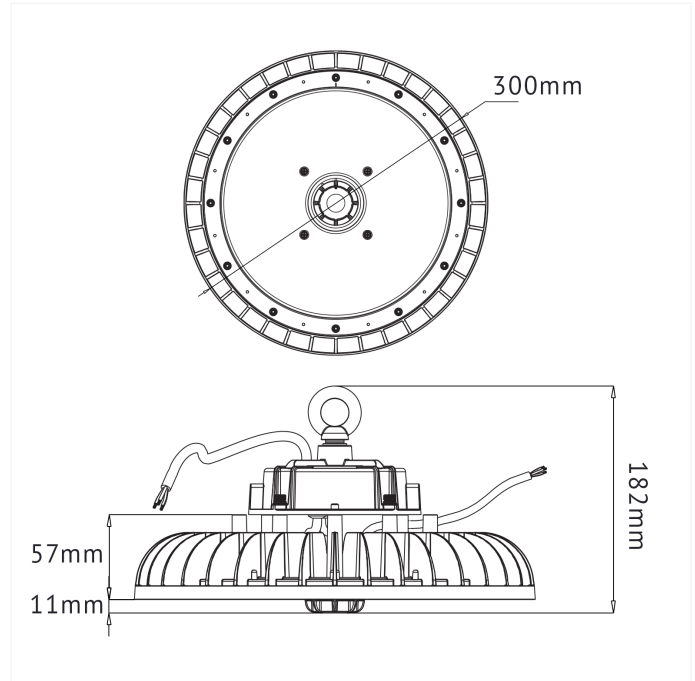

Ufo B High Bay 150W



Art. no: 4214-02-2

LIGHT TECHNICAL

Lightsource Type:	LED (built in)
Lumen Output:	24350
Lumen LED (tc=25):	26800
Beam Angle:	120
CCT (Color Temperature):	4000
CRI / Ra:	80
Color Code:	840
Lens (Diffuser):	Lens

PRODUCT

Ingress Protection:	IP65
Impact Protection:	IK08
Operating Temperature [°C]:	-35 - 50
Lifetime [h]:	L80B50: 76 000
Color:	Black
Height [mm]:	116
Width [mm]:	300
Weight [kg]:	2,65

ELECTRICAL DATA

Dimming:	1-10V, PWM
System Power [W]:	150
System Voltage [V]:	230V 50Hz
Protection Class:	1
Max load pr circuit - B10:	8
Max load pr circuit - B16:	13
Max load pr circuit - C10:	13
Max load pr circuit - C16:	22
Leakage current [mA]:	5
Inrush current I _{max} [A]:	80
Inrush current time [µs]:	164

MOUNTING / CONNECTION

Connection:	18i3 5m + 2x0,4m free end
Mounting:	Suspended