

Ledline

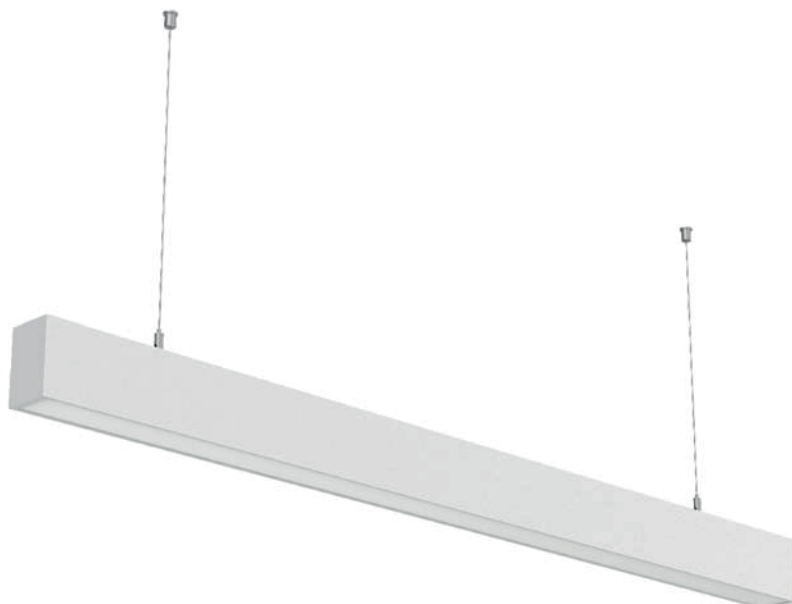

Description

Ledline linear light is combination of separated structures, it is convenient to dismantle and maintain because of its replaceable power supply and lighting emitting parts(PCB+LEDs), simple shape and random jointing can be realized. IP40 waterproof, so it is can be widely used in home, school, shopping mall, hotel and other indoor public places, and it is mainly made of aluminum alloy, PC.

Applications

Can be widely used in home, school, shopping mall, hotel and other indoor public places.



Features

1. The product can operate in single run or continuous runs seamless, when input voltage is AC220V, 110m can be connected; when input voltage is 110V, 60m can be connected.



2. The lamp and power supply is connected with high-voltage live part via connector; it is very convenient to install and disassemble, and it is also safe and reliable to use



4. PC diffuser and Al6063 aluminum profile, with good heat distribution and high light efficiency.

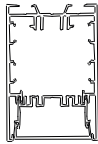

5. The end cap, power supply, emitting parts can be disassembled, convenient to maintain.



6.3 installation methods, suspending installation, embedded installation, and ceiling installation.

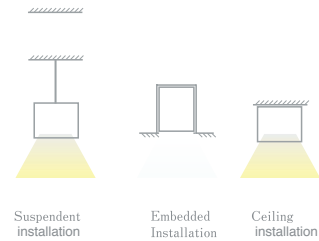

7. Multiple jointing can be realized via "+" "L" shape connecting accessories

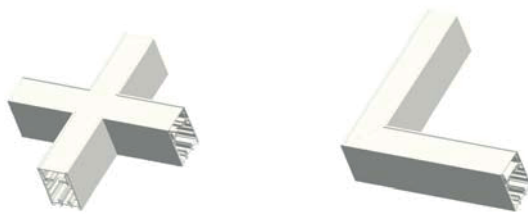

Dimensions (Unit: mm/inch)

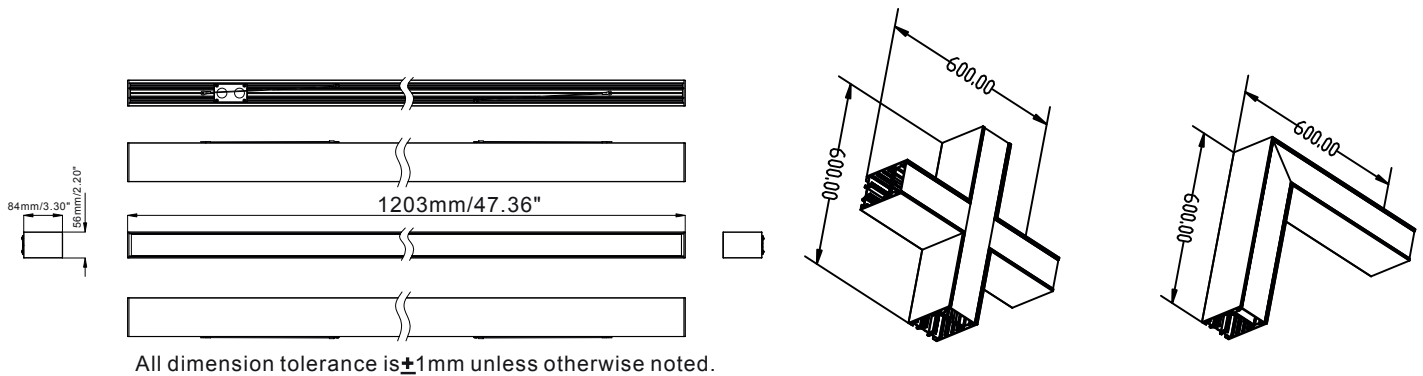

All dimension tolerance is ± 1 mm unless otherwise noted.

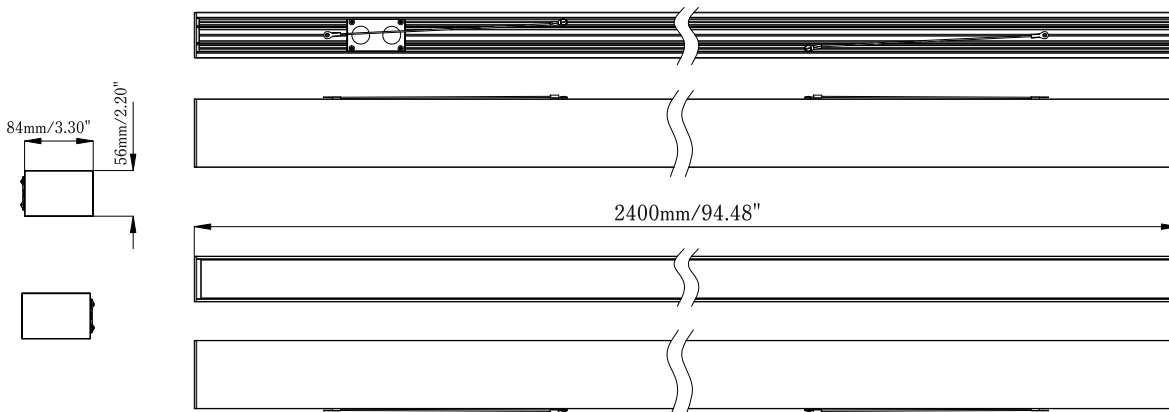

All dimension tolerance is ± 2 mm unless otherwise noted.

Electrical Connection

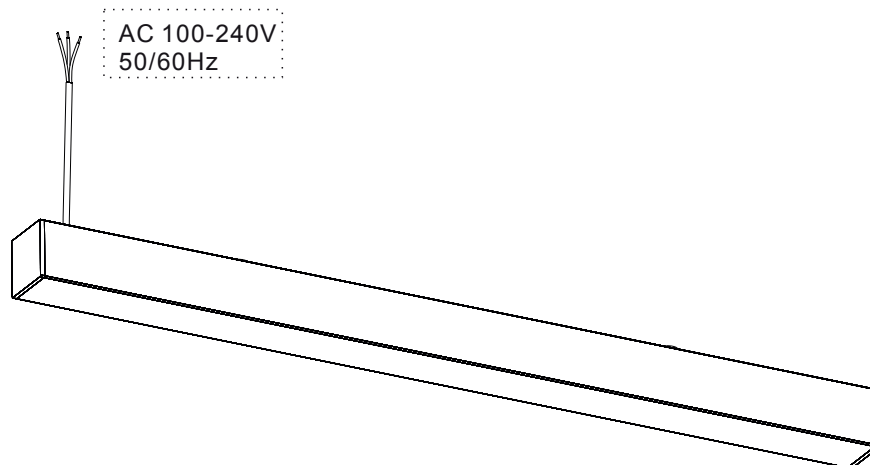

Suspending Installation

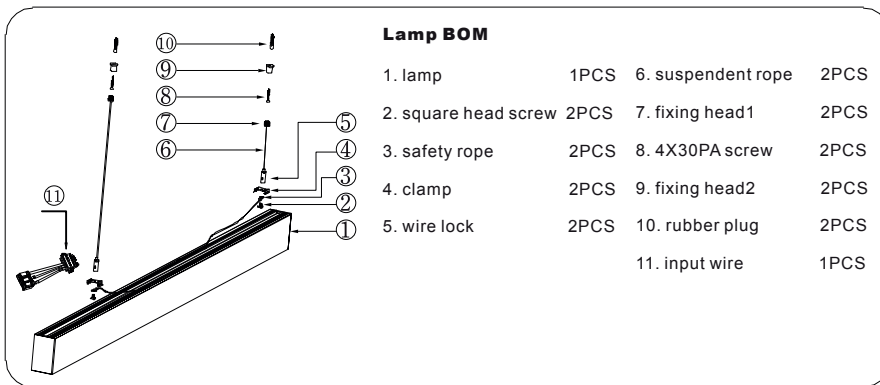

exploded drawing of suspending installation

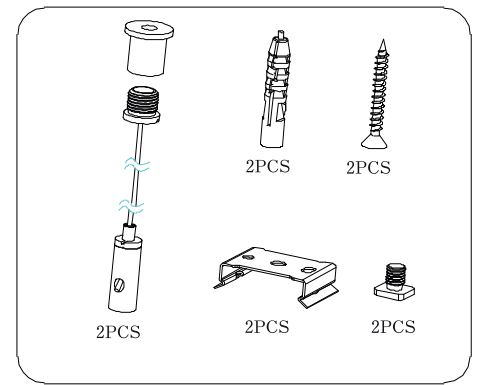

accessories drawing of suspending installation

Installation steps:

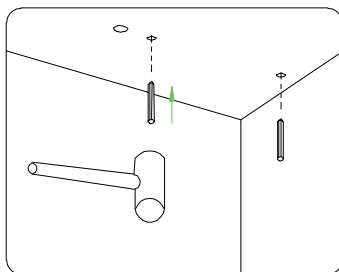

1. Confirm position of suspending wire installation hole and AC input wire hole and distance, then drill 2 installation holes of suspending rope and 1 AC input wire hole in the ceiling, finally hammer plastic rubber into 2 installation holes of suspending rope.

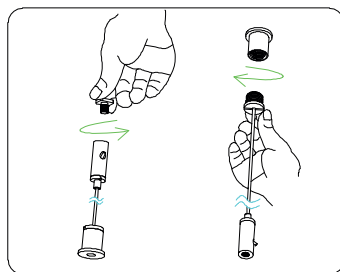

2. Wrench the square head screw and fixing head 2;

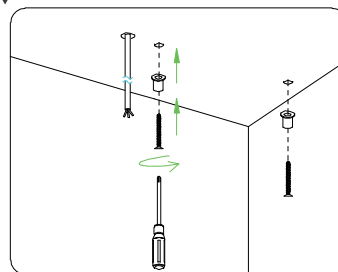

3. Thread screw through fixing head 2, and fasten fixing head 2 into rubber plug with cross-head screwdriver;

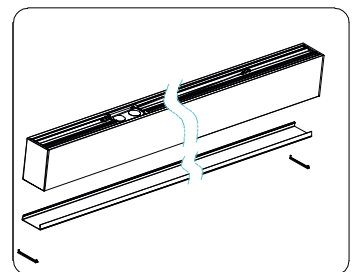

4. Dismantle inner side cover and PC cover

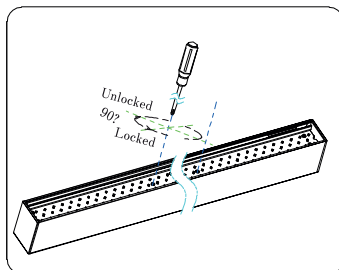

5. Rotate screws of fixing rotating card by 90°, and dismantle the cooling panel.

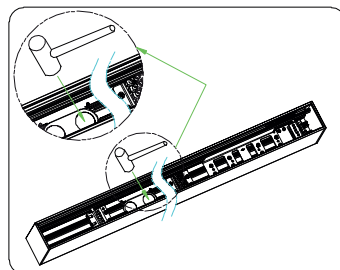

6. Knock off one hole of AC input wire on the right of lamp back;

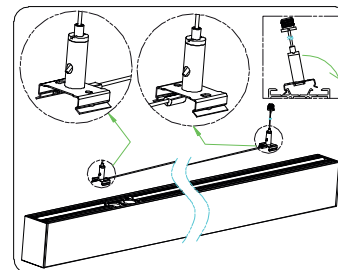

7. Thread the screw through fixing hole of clip and fasten with wire lock, and according to the planned distance of assembling suspending rope and above detail drawing, clip one side of suspending accessories on lamp, then rotate and install accessories to another side of lamp.

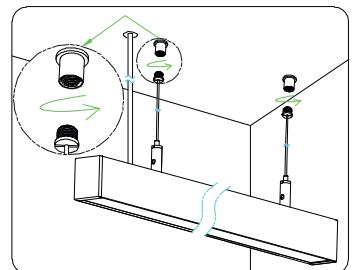

8. Screw fixing head 2 and the lamp with fixing head 1, and tighten them.

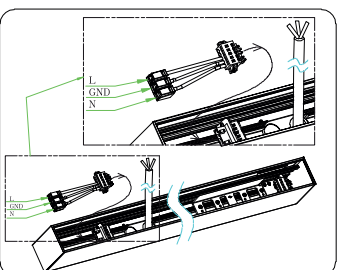

9. According to diagram, first connect male connector of input wire with female connector of lamp, and lead the AC input wire inside ceiling, then connect L, N and GND of input wire with L, N and GND of AC input wire correspondingly.

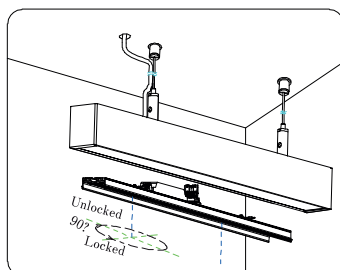

10. Assemble cooling plate into lamp shell, and rotate two screws of rotating card by 90° according to clockwise direction, then fasten cooling panel into lamp shell.

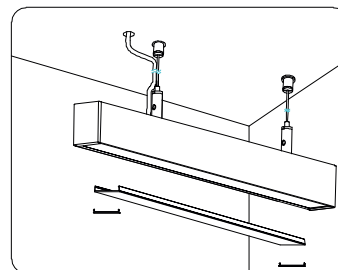

11. Install PC cover and inside cover on lamp.

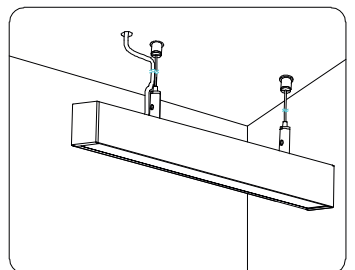

12. Light lamps, installation finish.

Embedded Installation

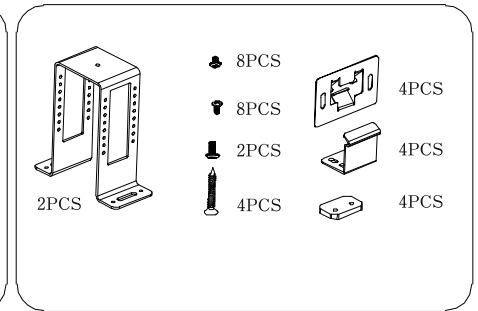
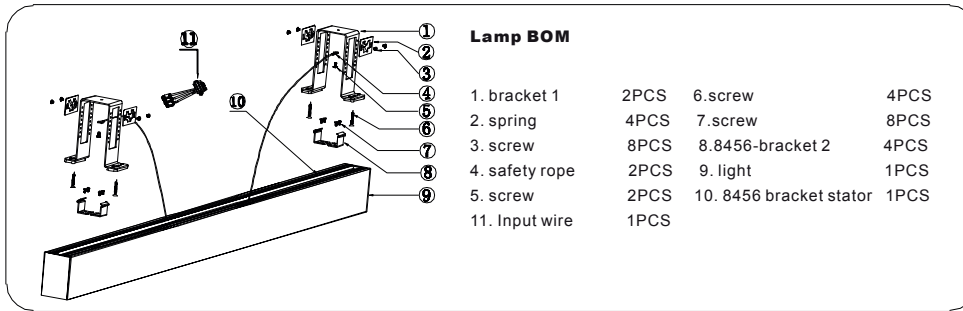

embedded exploded drawing

embedded accessories

Installation steps:

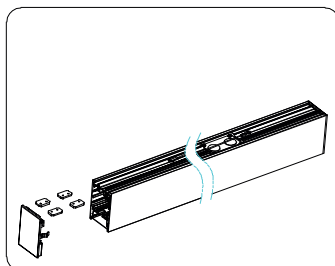

1. Dismantle side cover on one end of lamp, then snap fasteners into lamp slot, finally cover side cover;

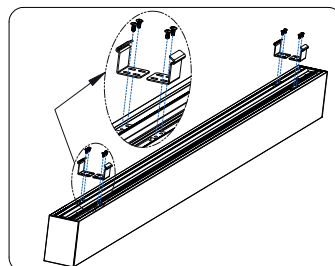

2. Confirm installation position, then fasten bracket 2 and stator on lamp with screws

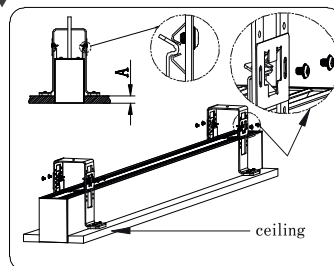

3. According ceiling thickness A, adjust position of shrapel on bracket 1, then fasten shrapel on bracket 1 with screws;

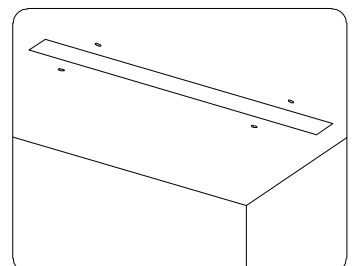

4. According lamp dimension and confirmed installation position, drill installation slot and fixing holes of bracket;

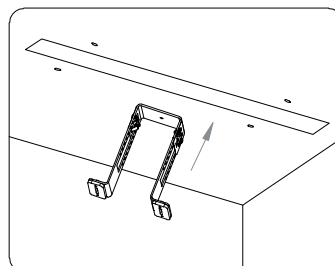

5. Put assembled bracket 1 laterally into ceiling slot, then rotate bracket 1 by 90°;

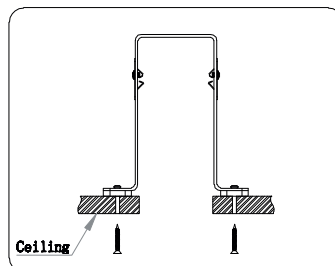

6. Fasten bracket 1 in the ceiling with screws, at the same time, lead AC input wire out of ceiling;

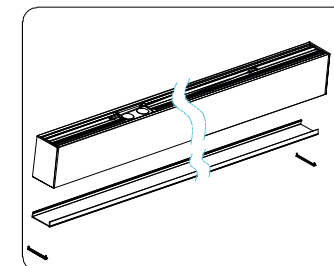

7. Dismantle internal side cover and PC cover;

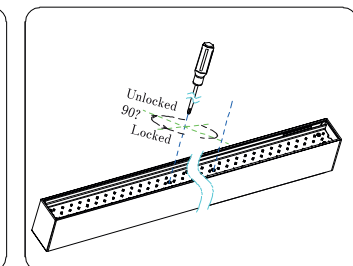

8. According diagram, rotate two screws of fixing rotation card by 90°, then dismantle cooling panel;

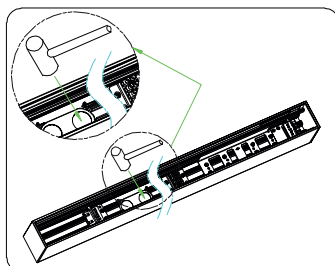

9. Knock off one hole of AC input wire on the right of lamp back;

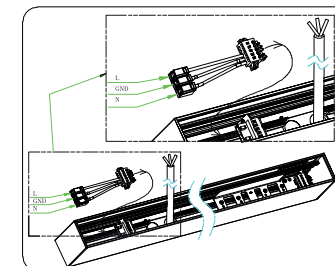

10. According diagram, first connect male connector of input wire with female connector of lamp, and lead the AC input wire inside ceiling, then connect L, N and GND of input wire with L, N and GND of AC input wire correspondingly.

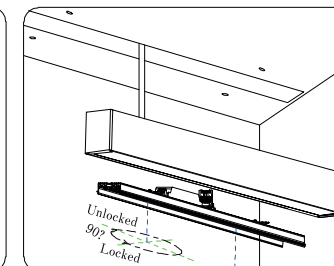

11. Assemble cooling plate into lamp shell, and rotate two screws of rotating card by 90° according clockwise direction, then fasten cooling panel into lamp shell;

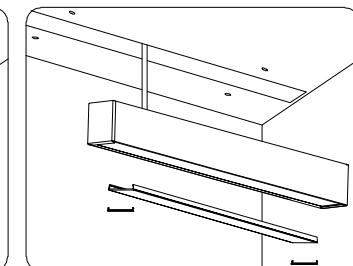

12. Install PC cover and inside cover on lamp.

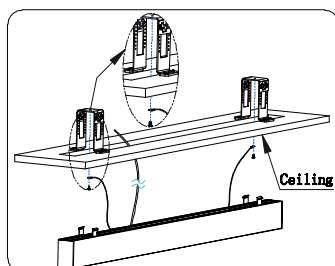

13. Thread screw through safety rope hole and fasten with bracket 1, and align the lamp to ceiling slot, then push it into buckle of bracket 1, after installation, the lamp surface should be flushed with ceiling surface;

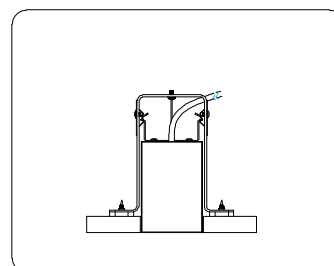

12. Light lamps, installation finish.

Ceiling Installation Instruction

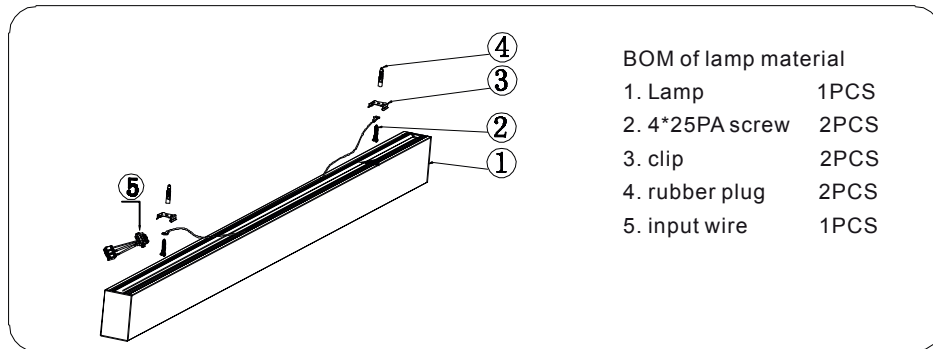

exploded drawing of ceiling installation

BOM of lamp material

1. Lamp	1PCS
2. 4*25PA screw	2PCS
3. clip	2PCS
4. rubber plug	2PCS
5. input wire	1PCS

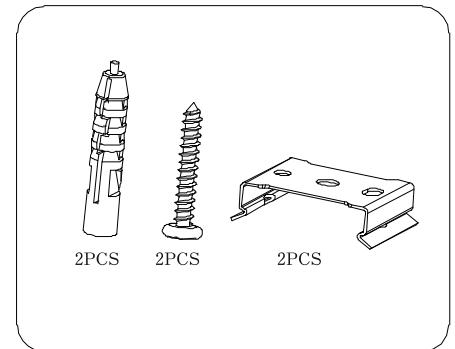

accessories

Installation steps:

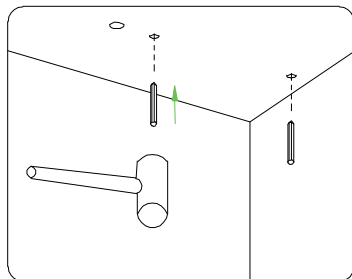

1. Confirm position of suspending wire installation hole and AC input wire hole and distance, then drill 2 installation holes of ceiling installation and 1 AC input wire hole in the ceiling, finally hammer plastic rubber into 2 installation holes of ceiling installation.

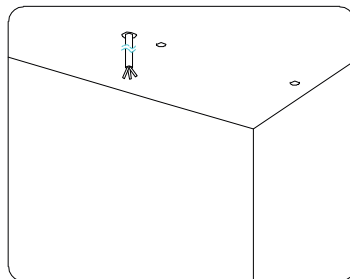

2. Lead AC input wire out of ceiling;

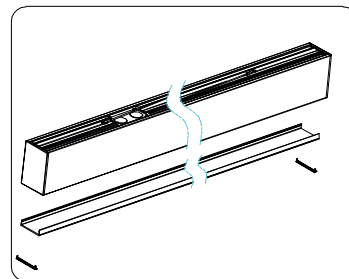

3. Dismantle inner side cover and PC cover

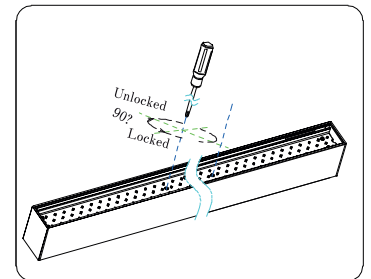

4. According to diagram, rotate screws of fixing rotating card by 90°, and dismantle the cooling panel.

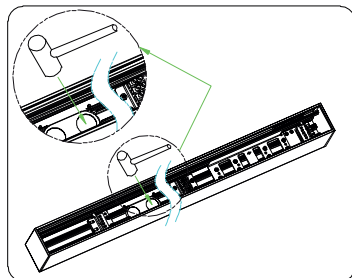

5. Knock off one knock-off hole of AC input wire on right side of lamp back;

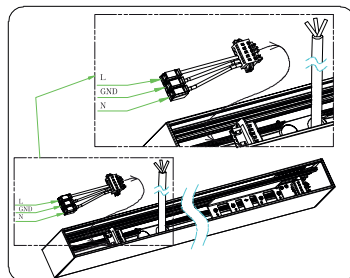

6. According diagram, first connect male connector of input wire with female connector of lamp, and lead the AC input wire inside ceiling, then connect L,N and GND of input wire with L,N and GND of AC input wire correspondingly;

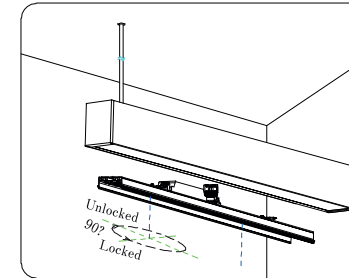

7. Assemble cooling plate into lamp shell, and rotate two screws of rotating card by 90° according clockwise direction, then fasten cooling panel into lamp shell;

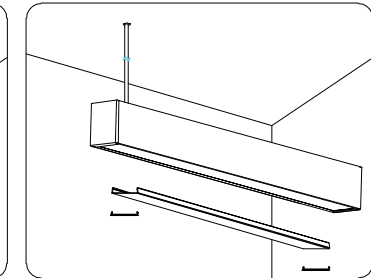

8. Install PC cover and inside cover on lamp;

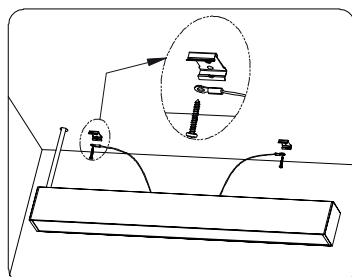

9. Thread screw through fixing hole of safety rope and hole of lamp then it is fastened with rubber plug in the ceiling;

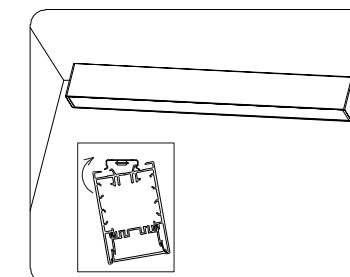

10. According above detailed figure, install one side on clamp, then rotate and install to another side of clamp; light lamps, installation finish.

Splicing Installation Instruction

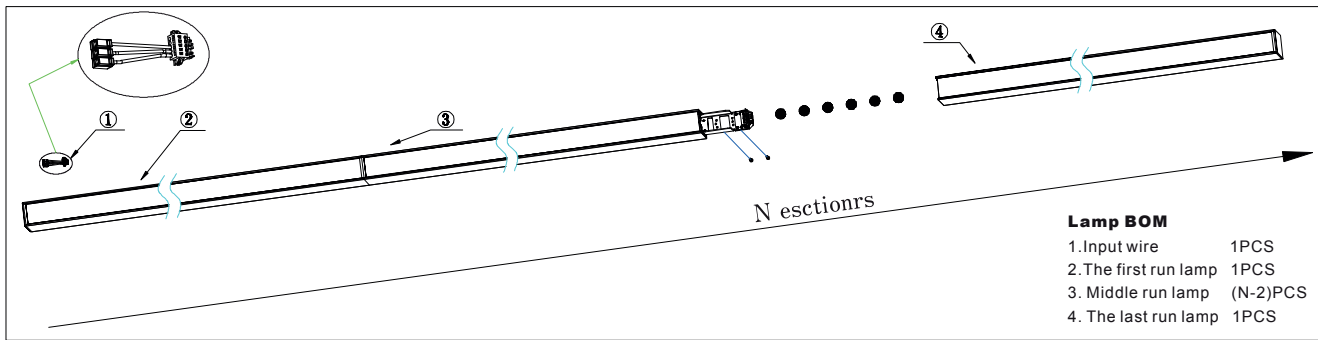

Splicing condition:

1. The total run of splicing lamp is N;
2. When input voltage is AC220V, total $P \leq 3450W$.
3. When input voltage is AC110V, Total $P \leq 1650W$

Installation steps:

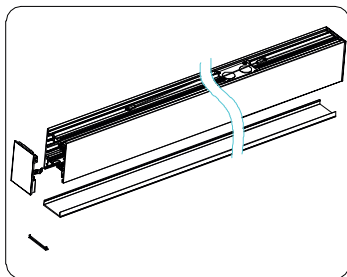

1. According diagram, dismantle inside cover, outside cover and PC cover on one end of the first run.

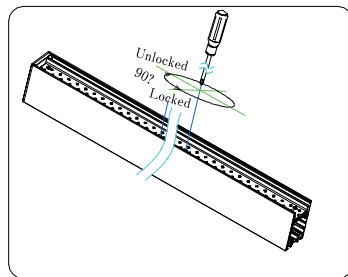

2. According diagram, rotate two screws of rotation card on the first run by 90° separately anticlockwise, then dismantle heat dissipating panel;

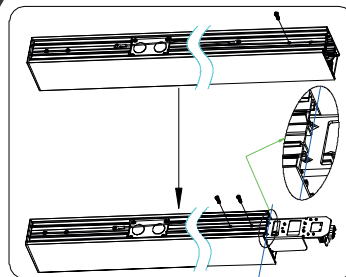

3. According diagram, remove 1 screw fixing connectors on the first run, and move connectors outward to dotted line position of location hole, then fasten connectors with 2 screws.

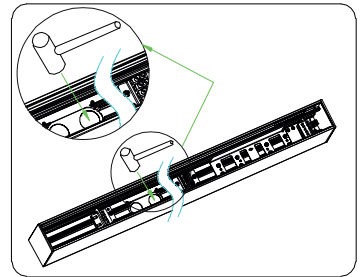

4. Knock off one knock-off hole of AC input wire on the right side on lamp back;

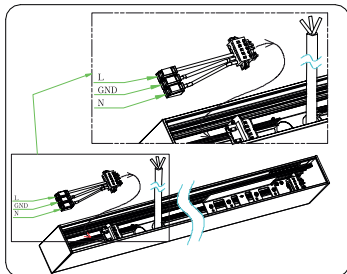

5. According diagram, first connect male connector of input wire with female connector of the first run, and lead the AC input wire inside ceiling, then connect L, N and GND of input wire with L, N and GND of AC input wire correspondingly.

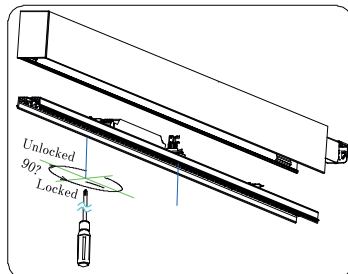

6. Assemble cooling plate into lamp shell of the first run, and rotate two screws of rotating card by 90° according clockwise direction, then fasten cooling panel into lamp shell.

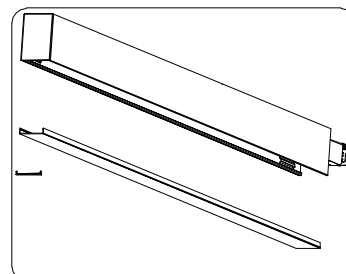

7. Install PC cover and inside cover on the first run of lamp;

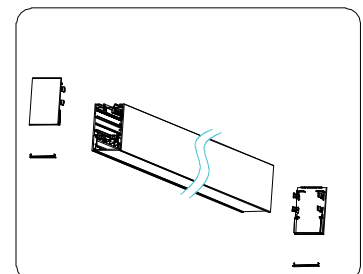

8. Dismantle inside cover and outside cover on both ends of the middle run;

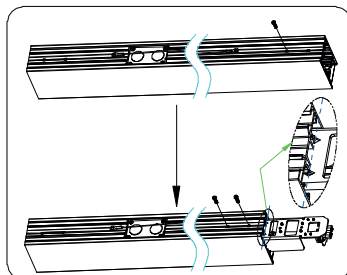

9. According diagram, remove 1 screw fixing connectors on all middle run, and move connectors outward to dotted line position of location hole, then fasten connectors with 2 screws.

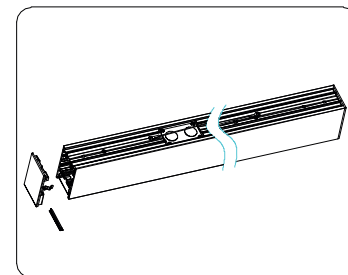

10. According diagram, dismantle inside cover and outside cover on one end of the last run.

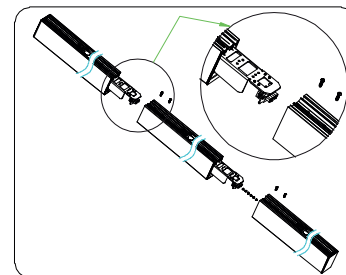

11. Splice the first run, middle run and the last run of all lights according diagram, then fasten connector with screws.

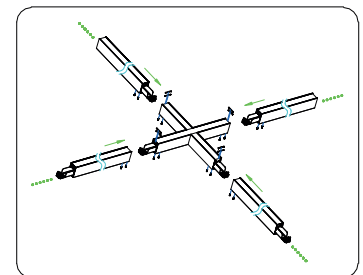

12. How to connect "+" shapes connector

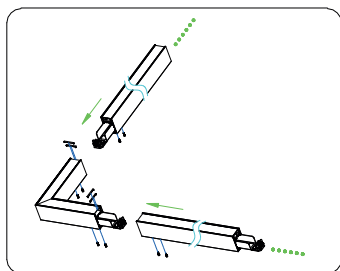

13. How to connect "L" shaped connector

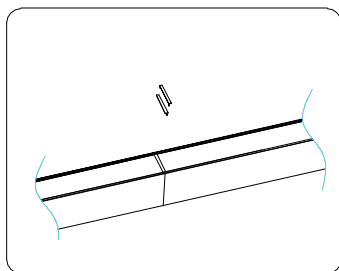

14. Install inside cover to all covers of lights and disconnecting position of cover, then install corresponding installation accessories; light the lights, installation finish.

! Notice

1. Please read the specification first, to make sure the service environment matches the condition in the specification before using.
2. Please confirm the input voltage, frequency before using.
3. The lamp must be installed by professional personnel
4. If there is any damage on the power line or the shell of the product, it should be taken as defective product and do not use it.;
5. Dangerous high voltage, Non-professionals are not allowed to maintain the products.
6. If the exterior flexible cable or wire is damaged, it must be exchanged by the supplier, its agent or other similar qualified personnel to avoid dangers.