



FDV SPEC SHEET

Theros Lite

Art. no: 101745-01-1

Ledpro
by NORLUX

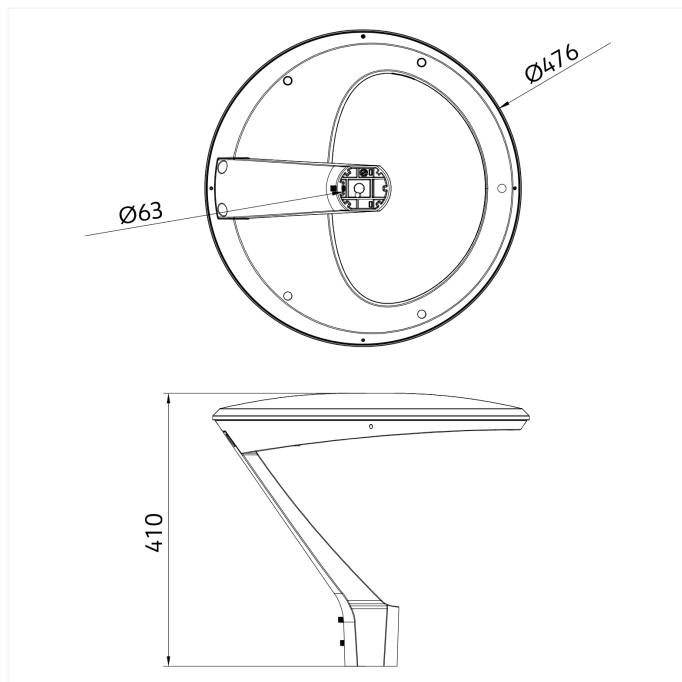

Theros Lite



A⁺⁺

Art. no: 101745-01-1

LYS TEKNISK

Lumen LED (tc=25):	4030
Fargetemperatur [K]:	4000
Fargegjengivelse [CRI/Ra]:	80
Fargekode:	840

MONTERING / TILKOBLING

Tilkobling:	Kabel 5m
Montering:	Mast

PRODUKT

IP-grad:	IP66
Vandal klasse:	IK08
Driftstemperatur [°C]:	-30 - 50
Forventet Levetid :	L80B10: 100 000
Farge :	Grå
Lengde [mm]:	476
Bredde [mm]:	410
Vekt [kg]:	7,1

ELEKTRISK DATA

Dimmetype:	Ingen
Systemeffekt [W]:	31
Spenning [V]:	230V 50Hz
Isolasjonsklasse:	1
Sokkel :	N/A