

Ray Mini

18159-6-20-3-ddd



Ray Mini uses the possibilities created by new technology. The LED driver is mounted inside the luminaire body. This gives us a slim design combined with a powerful lightoutput that can be easily adjusted in all directions to meet all needs. Ray Mini can be tilted 90 degrees and rotated 350 degrees its own axis. To create further opportunities to play with light you can mount a diffuser on the luminaire, this can be ordered separately.



Lyskilde :	LED (built in)
Systemeffekt [W]:	23W
Fargetemperatur [K]:	4000K
Fargegjengivelse [CRI/Ra]:	90
Lumen LED (tc=25):	3100lm
Spredningsvinkel [°]:	20°
Optikk:	Clear
Dimmetype:	DALI
Spenning [V]:	230V 50Hz
Tilkobling:	Track 3-Circuit+dim
Montering:	Tak, Skinne
Fargetoleranse [SDCM]:	3
Farge :	White
Høyde [mm]:	200mm
Bredde [mm]:	110mm

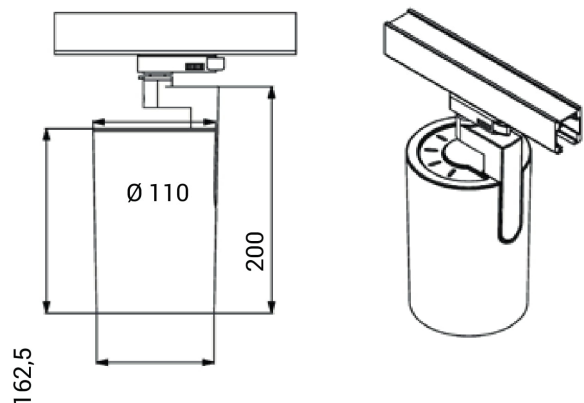

Alle spesifikasjoner er nominelle verdier, avvik kan forekomme.
Produktspesifikasjoner kan endres uten varsel.

Elektrisk utstyr beregnet for å være del av et fast elektrisk anlegg kan kun installeres av et registrert installasjonsfirma.