



FDV SPEC SHEET

Ray Mini

Art. no: 18160-6-20-3



Lighting Solutions

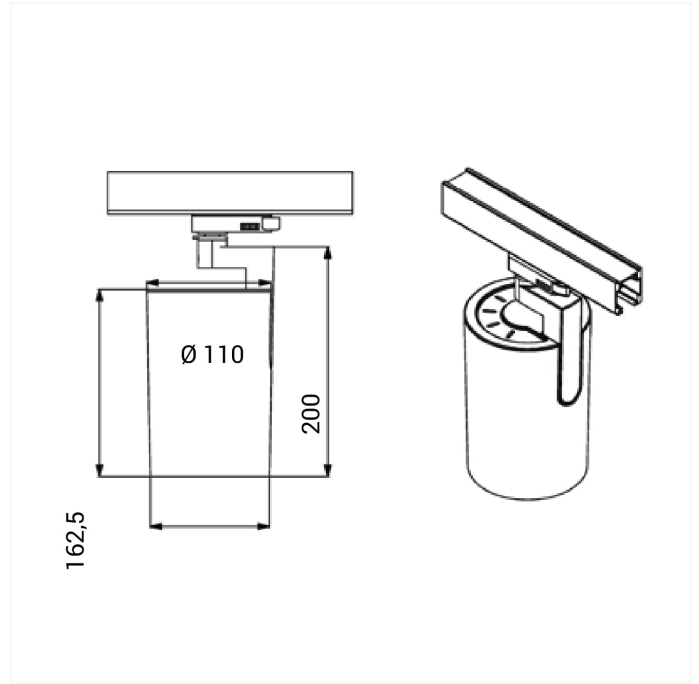

Ray Mini



Art. no: 18160-6-20-3

LIGHT TECHNICAL

Lightsource Type:	LED (built in)
Lumen Output:	3179
Lumen LED (tc=25):	3600
Beam Angle:	20°
CCT (Color Temperature):	4000
CRI / Ra:	80
Color Code:	840
MacAdam (SDCM):	3
Lens (Diffuser):	Clear
UGR (<=):	16

MOUNTING / CONNECTION

Connection:	Track 3-Circuit
Mounting:	Ceiling, Track

ELECTRICAL DATA

Dimming:	None
System Power [W]:	23
System Voltage [V]:	230V 50Hz
Protection Class:	1
Max load pr circuit - B10:	14
Max load pr circuit - B16:	24
Max load pr circuit - C10:	24
Max load pr circuit - C16:	40
Inrush current I _{max} [A]:	25
Inrush current time [μs]:	150
Socket / Cap-Base:	N/A
Current Output [mA]:	600
Voltage Forward Min [V]:	30,2
Voltage Forward Max [V]:	41,7



FDV SPEC SHEET

Ray Mini

Art. no: 18160-6-20-3



Lighting Solutions

PRODUCT

Ingress Protection:	IP20
Operating Temperature [°C]:	-
Color:	White
Height [mm]:	200
Width [mm]:	110