



PRODUCT SHEET

Cylinder 60
Art. no: 60127-7-38-2



Lighting Solutions

Cylinder 60

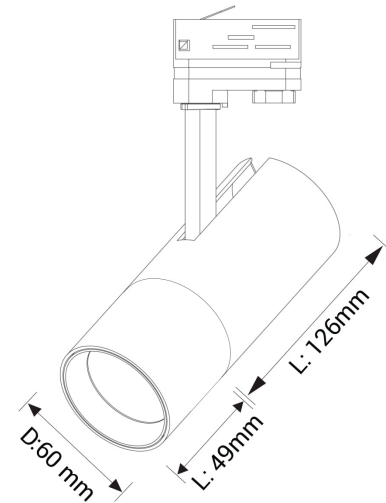

SPECIFICATIONS

Lightsource Type:	LED (built in)
System Power [W]:	14W
CCT (Color Temperature):	2700K
CRI / Ra:	90
Lumen LED (tc=25):	1550lm
Beam Angle:	38° (15° & 25°)
Lens (Diffuser):	Clear
Dimming:	Phase-Cut
System Voltage [V]:	230V 50Hz
Connection:	Track 1-Circuit
Mounting:	Track, Ceiling
Lifetime [h]:	L80B10: 60 000h
Color:	Black
Height [mm]:	220mm
Width [mm]:	60mm
Weight [kg]:	0,6kg

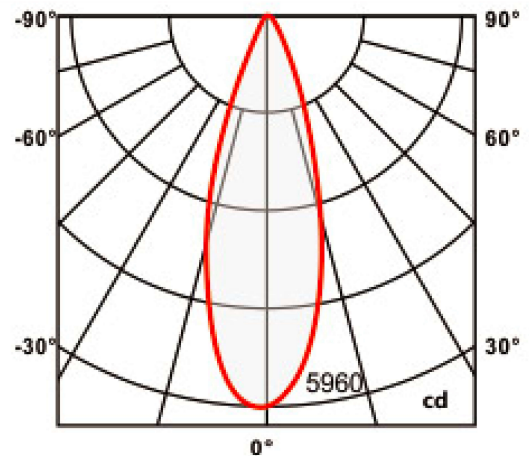

The Cylinder 60 has the LED driver included in the lamp head for use in 1-circuit tracks, It can be tilted 90 degrees and rotated 350 degrees on its own axis and comes with a variety of accessories. Delivered with 2700K, CRI90 and are phasecut dimmable. Choose between 15°, 25° and 38° lens, which are all included. 38° are standard lens on luminaire.