



FDV SPEC SHEET

Lobus BI

Art. no: 7008-7-40-1



Lighting Solutions

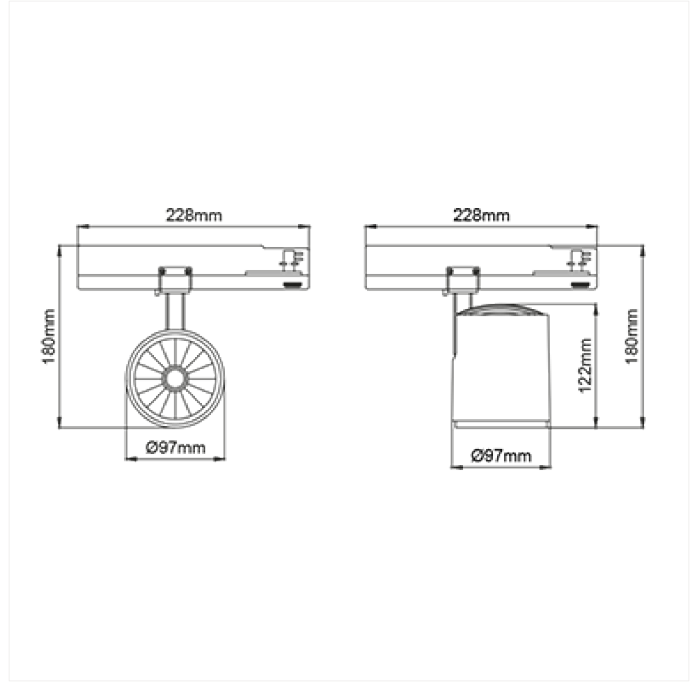

Lobus BI



Art. no: 7008-7-40-1

LIGHT TECHNICAL	
Lightsource Type:	LED (built in)
Lumen Output:	3770
Lumen LED (tc=25):	3800
Beam Angle:	40°
CCT (Color Temperature):	2700
CRI / Ra:	90
Color Code:	927
MacAdam (SDCM):	3
Lens (Diffuser):	Clear
MOUNTING / CONNECTION	
Connection:	Track 3-Circuit
Mounting:	Ceiling, Track

ELECTRICAL DATA	
Dimming:	None
System Power [W]:	30
System Voltage [V]:	230V 50Hz
Protection Class:	1
Max load pr circuit - B10:	30
Max load pr circuit - B16:	50
Max load pr circuit - C10:	50
Max load pr circuit - C16:	85
Inrush current I _{max} [A]:	5
Inrush current time [µs]:	50
Socket / Cap-Base:	N/A



FDV SPEC SHEET

Lobus BI

Art. no: 7008-7-40-1



Lighting Solutions

PRODUCT

Ingress Protection:	IP20
Operating Temperature [°C]:	-
Lifetime [h]:	L80B10: 50.000
Color:	Grey
Length [mm]:	228
Height [mm]:	180
Width [mm]:	97
Weight [kg]:	1,1