



FDV SPEC SHEET

Auriga

Art. no: 737-40-3



Lighting Solutions

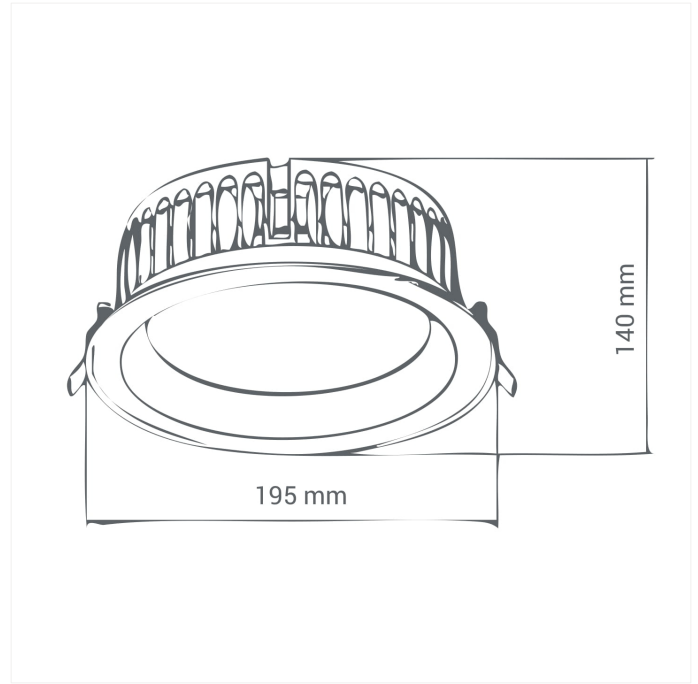

Auriga

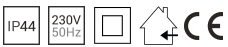

Art. no: 737-40-3

LIGHT TECHNICAL

Lightsource Type:	LED (built in)
Lumen Output:	2700
Lumen LED (tc=25):	2700
Beam Angle:	40°
CCT (Color Temperature):	3000
CRI / Ra:	80
Color Code:	830
Lens (Diffuser):	Clear

MOUNTING / CONNECTION

Cut-out [mm]:	176
Mounting:	Recessed

ELECTRICAL DATA

Dimming:	None
System Power [W]:	31
System Voltage [V]:	230V 50Hz
Protection Class:	2
Max load pr circuit - B10:	27
Max load pr circuit - B16:	44
Max load pr circuit - C10:	45
Max load pr circuit - C16:	74
Inrush current I _{max} [A]:	7
Inrush current time [μs]:	25
Socket / Cap-Base:	N/A
Current Output [mA]:	700



FDV SPEC SHEET

Auriga

Art. no: 737-40-3



Lighting Solutions

PRODUCT

To be recessed in insulation:	No
Ingress Protection:	IP44
Impact Protection:	IK05
Operating Temperature [°C]:	-
Lifetime [h]:	L80B10: 75 000
Color:	White
Height [mm]:	140
Width [mm]:	195