

# Lorenzo

## INSTALLATION MANUAL



### ⚠ Safety Notes:

- The product must be installed, maintained, and operated as instructions below.
- Before starting installation of this product, make sure power supply is disconnected.
- Only to be installed by authorized electrician.
- Do not use abrasives or solvents when cleaning.
- Do not install the product if it appears damaged in any way. Check with manufacturer if in doubt.
- Do not modify this fitting in any matter as this will void warranty.
- Check protection class, if class I, it must be earthed.
- Disconnect power supply before maintenance or cleaning.

### ⚠ Sikkerhetsinformasjon:

- Følg installasjonsmanual for korrekt montering.
- Koble alltid fra strømmen før montering eller vedlikehold.
- Kan kun monteres av autorisert elektriker.
- Monter ikke produktet hvis det er synlig skade. Kontakt forhandler eller produsent.
- Bruk ikke løsemidler ved rengjøring
- Produktet skal ikke under noen omstendigheter endres eller modifiseres.
- Sjekk produktets isolasjonsklasse. Ved isolasjonsklasse I skal produktet jordes.

# CONTENTS

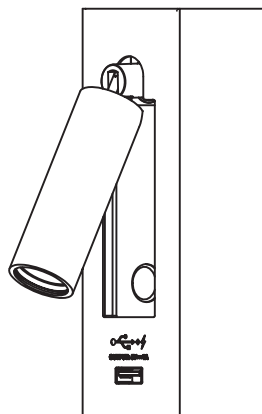

1 x main body



2 x Raw plugs



2 x Wall Screws

## BEFORE YOU START

It is extremely important that these instructions are read carefully and any illustrations studied before commencing installation .

Please retain these instructions for future reference.

## WARNING!

- Electricity can be dangerous.
- Do not attempt to fit installation unless you are competent.
- If in any doubt consult a qualified electrician to complete electrical installation.
- Installation to comply with current IEE wiring regulations
- The lighting is for use in a normal dry domestic indoor environment.
- If you find any damage to the electrical parts, please ask a qualified electrician to replace it.
- USB charging plug is use for charging only , not waterproof. The USB plug is live, please do not touch it with wet hand. Please do not plug in the port with any non-USB plug.

## Installation

- Take care when handling and installing to avoid damage to the product.
- Avoid mounting the fitting on a damp surface such as newly painted or plastered area as this may cause discoloration of the finish.

## Tools

- Cross headed screwdriver.

## Cleaning Instructions and Care

- Take extra care when cleaning and assembling.
- Do not use any chemical or abrasive agents to clean the shade.

# Installation Method 1

1. Making sure that the power source is still accessible. Drill the surface to fit the section wall light using the metal bracket to locate the holes position. Please ensure that no pipes or cables are within the drilling area.
2. Screw the metal bracket onto the wall using the selftaping screws and raw plugs if necessary.

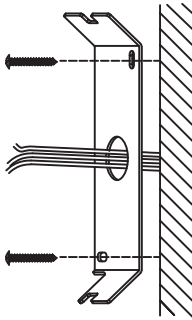

3. Using the connector block to connect to the mains power supply as shown below.

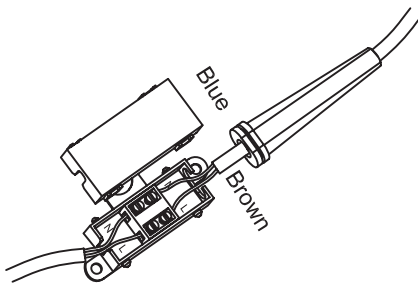

4. Fix the back plate on the wall to hide the cable, fixings and power connection.

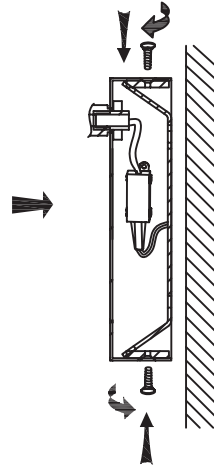

5. USB port output:5V-1A  
Use USB cable to charge your adaptive mobile devices. After the charging is finished, disconnect the device from the USB port.

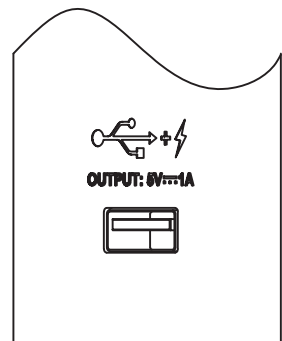

## Installation Method 2 :

This installation is suitable for the installation area with an outlet.  
Additional purchasing cable with plug is necessary

1. Please ensure that no pipes or cables are within the drilling area.
2. Screw the metal bracket onto the wall using the selftaping screws and raw plugs if necessary.

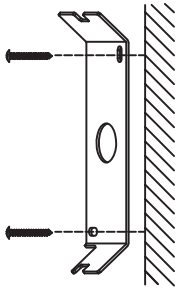

3. Put the cable with plug through the cable entry hole beneath the wall base and pass through the connector box. Crimp the cable with wire stopper and lock it up.

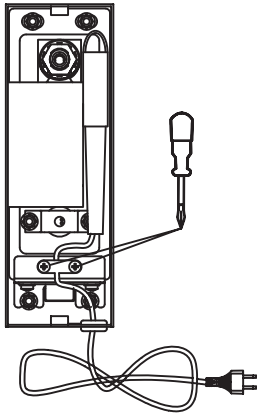

5. Fix the back plate on the wall to hide the cable, fixings and power connection.

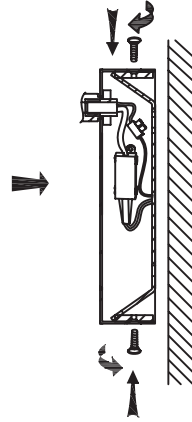

6. Plug in and enjoy your light

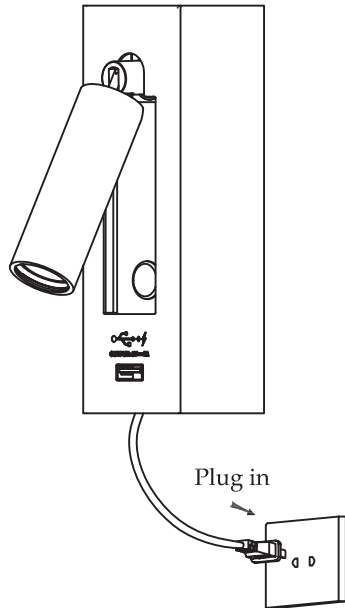

4. Using the connector block to connect to the mains power supply as shown below.

