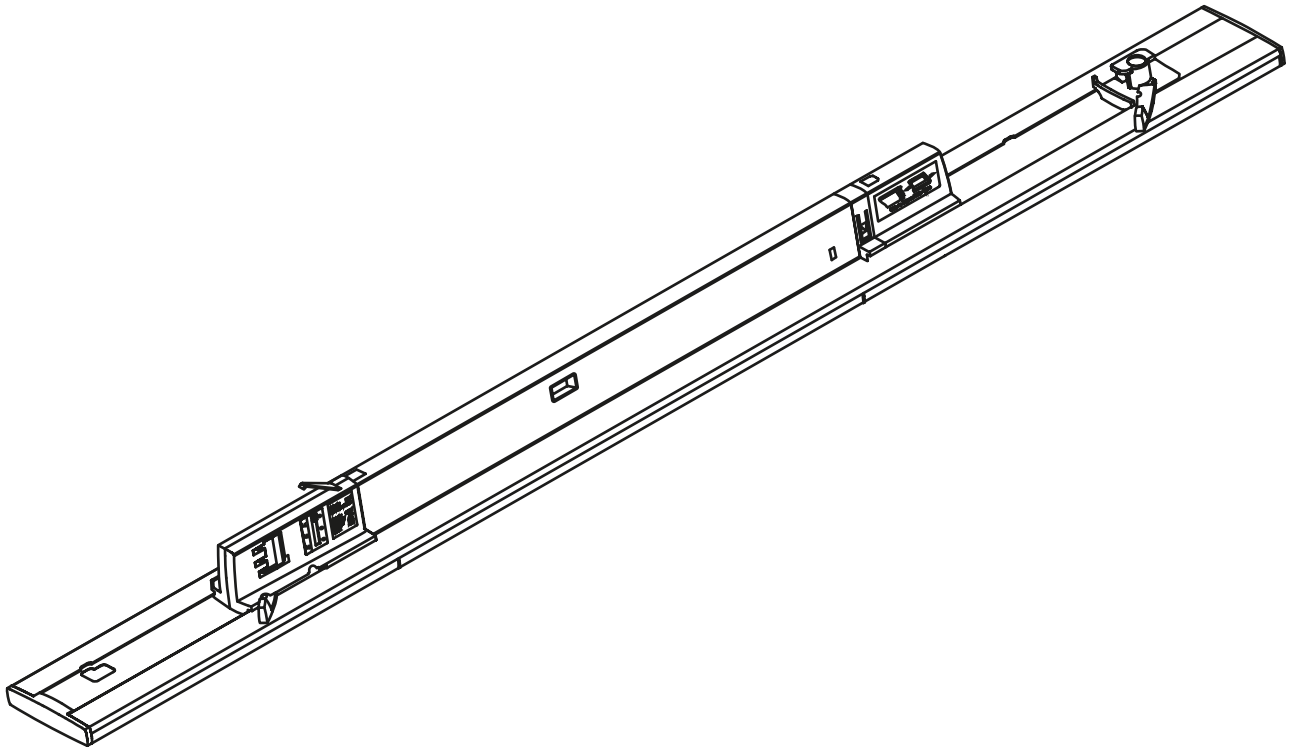

ART. NO.

5035-90-3
5036-90-3
5030-01-2
5030-01-3
5030-90-3

5031-90-3
5040-90-3
5030-DS-2
5030-DS-3
5030-90-2

NORLUX®*Lighting Solutions*

T-Line

INSTALLATION MANUAL

**⚠ Safety Notes:**

- The product must be installed, maintained, and operated as instructions below.
- Before starting installation of this product, make sure power supply is disconnected.
- Only to be installed by authorized electrician.
- Do not use abrasives or solvents when cleaning.
- Do not install the product if it appears damaged in any way. Check with manufacturer if in doubt.
- Do not modify this fitting in any matter as this will void warranty.
- Check protection class, if class I, it must be earthed.
- Disconnect power supply before maintenance or cleaning.

⚠ Sikkerhetsinformasjon:

- Følg installasjonsmanual for korrekt montering.
- Koble alltid fra strømmen før montering eller vedlikehold.
- Kan kun monteres av autorisert elektriker.
- Monter ikke produktet hvis det er synlig skade. Kontakt forhandler eller produsent.
- Bruk ikke løsemidler ved rengjøring
- Produktet skal ikke under noen omstendigheter endres eller modifiseres.
- Sjekk produktets isolasjonsklasse. Ved isolasjonsklasse I skal produktet jordes.

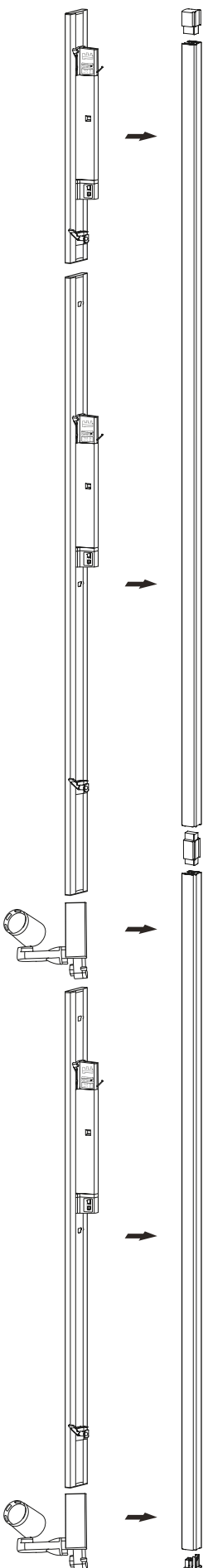

Features:

Perfect solution for the retail business, shops, and supermarkets.
 Excellent quality with high efficiency up to 160lm/W.
 Four selectable powers with DIP switch.
 Flexible position of the luminaire in the rail by sliding left or right.

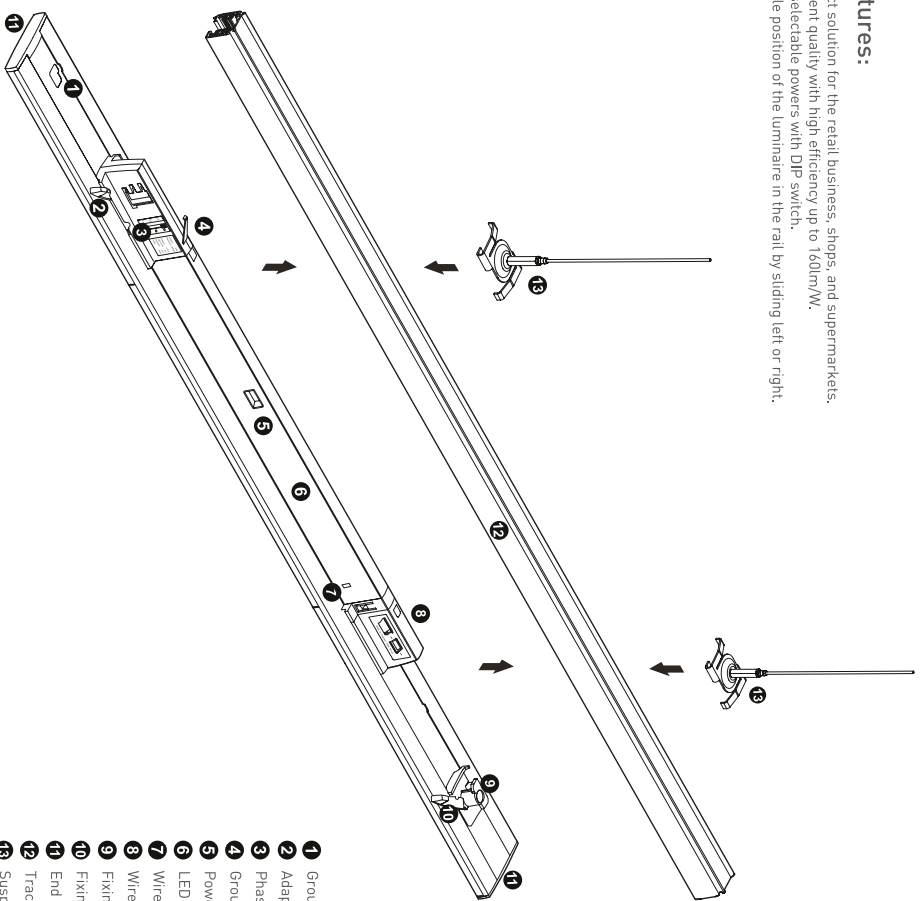

- 1 Ground point
- 2 Adaptor knob
- 3 Phase selector
- 4 Ground pin
- 5 Power selector
- 6 LED driver
- 7 Wires lock
- 8 Wires box
- 9 Fixing knob
- 10 End cap
- 11 Track rail
- 12 Suspension kit

Step 1
 Set the power in the **5 power selector** DIP switch.

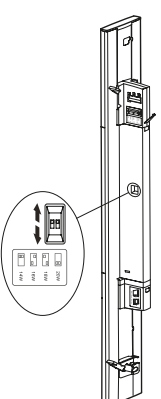

Step 2
 Choose the phase/circuit in the **3 phase selector** DIP switch.

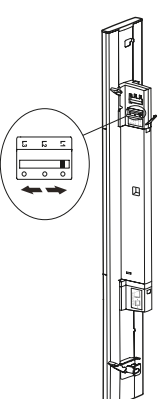

Step 3
 Insert the T-line luminaire into the **12 track rail** with the correct direction.

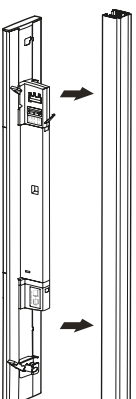

Step 4
 Lock the luminaire with the **2 adaptor knob** and the **10 fixing knob** by rotating the knobs clockwise.

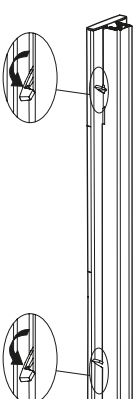

How to avoid the track rail joints during installation

There are 4 movable positions for the LED driver in the T-line luminaire.
There are 2 movable position of the fixing lock in the T-line luminaire.

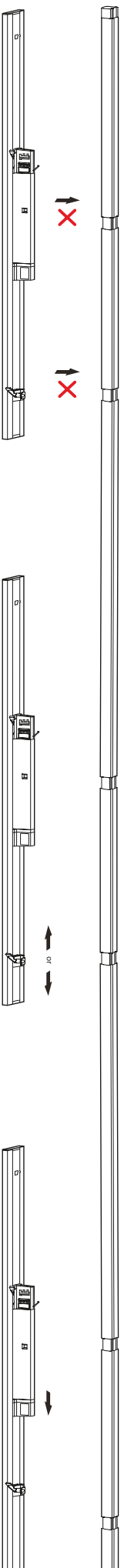

If the **12 track rail joint** interferes with the position of the **9 Fixing lock**, follow the instruction of **Step 3**.

If the **12 track rail joint** interferes with the position of the **8 LED driver**, follow the instructions from **Step 2** to **Step 3**.

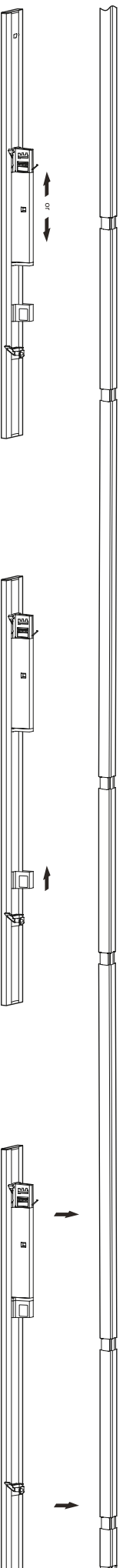

Step 3

Slide the **8 LED driver** left or right to a free position.

Step 4

Slide the **8 wires box** near the **8 LED driver**. Tidy up the wires and hide them by sliding the **8 wires box** back.

Step 5

Install the T-Line luminaire into the **12 track rail**.

Track rail (4 wires/3 phases) European standard

Recommend track rail brands

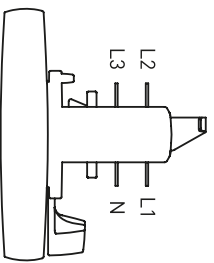

- 11** L1 as a phase
- 12** L2 as a phase
- 13** L3 as a phase
- N** Neutral Conductor

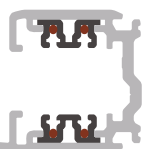

Global

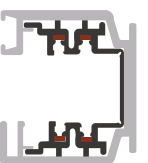

Eutrac

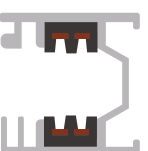

Staff

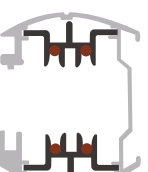

Ivela

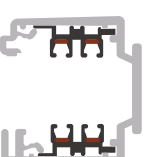

Unipro

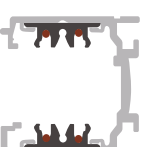

Stucchi