



FDV SPEC SHEET

Halo Pendant

Art. no: 1129-1-120-2



Lighting Solutions

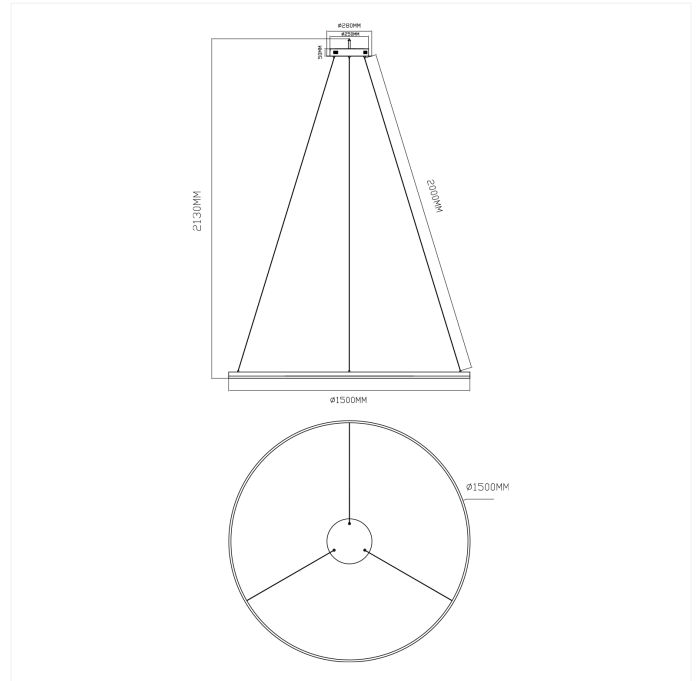

Halo Pendant



Art. no: 1129-1-120-2

LIGHT TECHNICAL

Lightsource Type:	LED (built in)
Lumen Output:	2500
Lumen LED (tc=25):	6100
Beam Angle:	120
CCT (Color Temperature):	3000
CRI / Ra:	80
Color Code:	830
Lens (Diffuser):	Frosted

MOUNTING / CONNECTION

Connection:	18i3 Quick connection
Mounting:	Ceiling, Pendant

PRODUCT

Ingress Protection:	IP20
Color:	Black
Height [mm]:	34
Width [mm]:	1500

ELECTRICAL DATA

Dimming:	None
System Power [W]:	53
System Voltage [V]:	230V 50Hz
Protection Class:	2
Leakage current [mA]:	0,5
Inrush current I _{max} [A]:	5
Voltage Forward Min [V]:	66
Voltage Forward Max [V]:	72