

ART. NO.
000

NORLUX[®]

Lighting Solutions

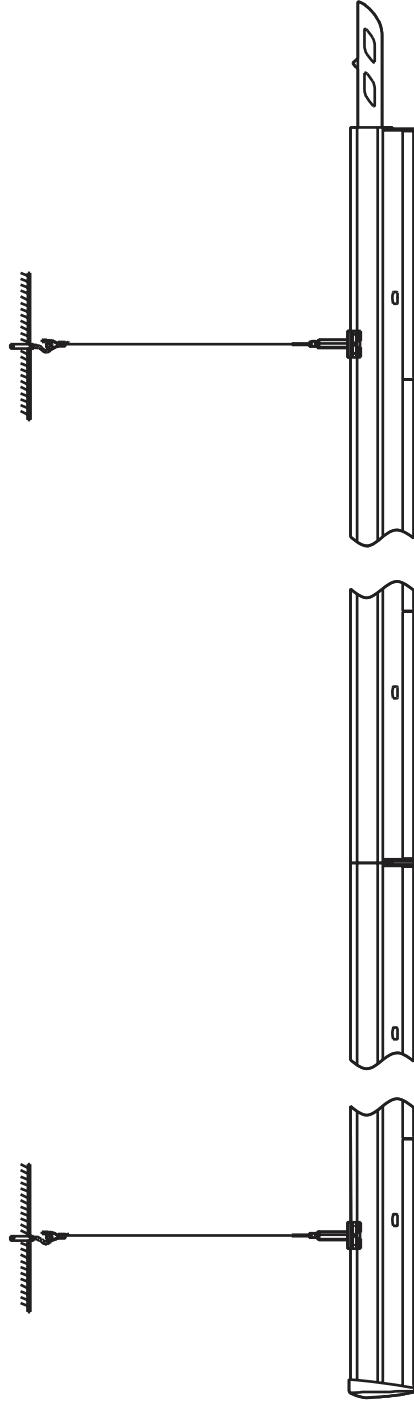

Trunk

INSTALLATION MANUAL



⚠ Safety Notes:

- The product must be installed, maintained, and operated as instructions below.
- Before starting installation of this product, make sure power supply is disconnected.
- Only to be installed by authorized electrician.
- Do not use abrasives or solvents when cleaning.
- Do not install the product if it appears damaged in any way. Check with manufacturer if in doubt.
- Do not modify this fitting in any matter as this will void warranty.
- Check protection class, if class I, it must be earthed.
- Disconnect power supply before maintenance or cleaning.

⚠ Sikkerhetsinformasjon:

- Følg installasjonsmanual for korrekt montering.
- Koble alltid fra strømmen før montering eller vedlikehold.
- Kan kun monteres av autorisert elektriker.
- Monter ikke produktet hvis det er synlig skade. Kontakt forhandler eller produsent.
- Bruk ikke løsemidler ved rengjøring
- Produktet skal ikke under noen omstendigheter endres eller modifiseres.
- Sjekk produktets isolasjonsklasse. Ved isolasjonsklasse I skal produktet jordes.

Safety notes:
Installation should be performed only by qualified electrician .

- Make sure no voltage while installation .
- Connect cable wires according to wire labeling.
- Max current should not exceed 16A in one power feed in circuit.

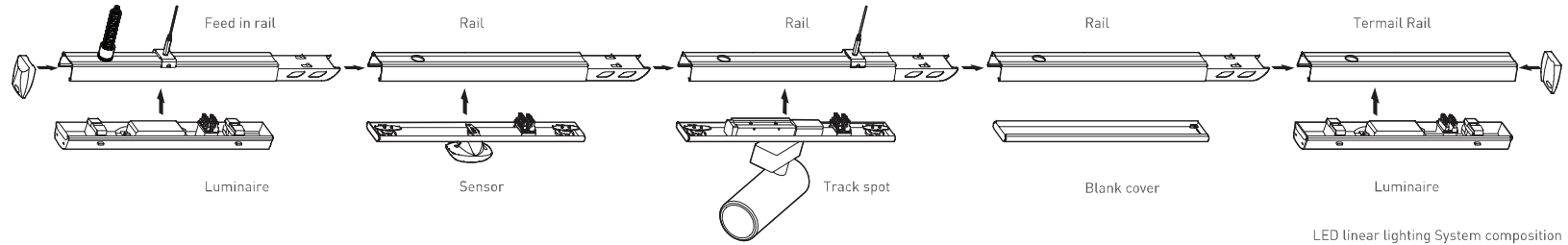

Terminal module:

Terminal module can be independently installed as a single unit, it also can be connected at end of one linear light row.

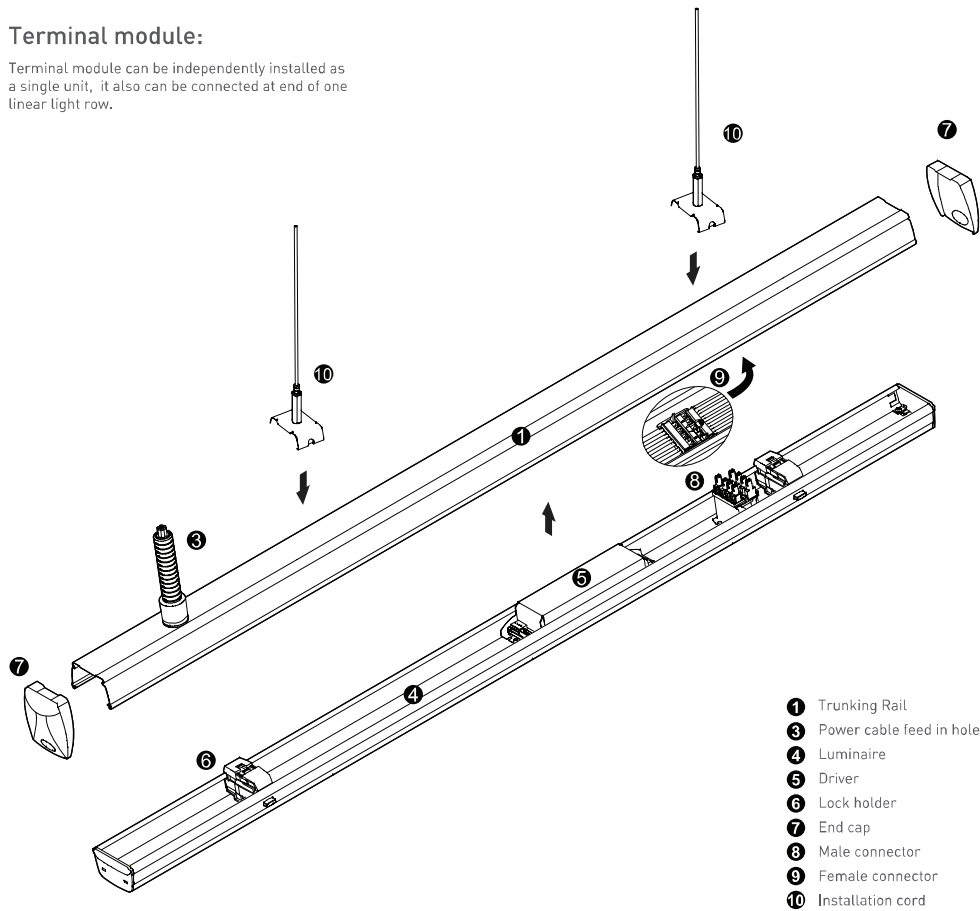

Step 1
Mounting Suspension
Drill a hole on ceiling

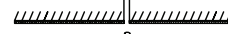

Fix mounting hook into ceiling

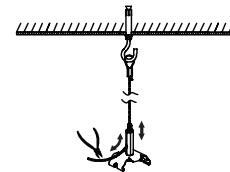
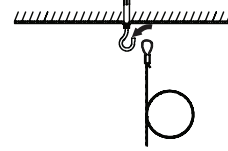

Adjust length of suspension cord:
a. press down Hexagon bolt;
b. Pull in/out cord to adjust length

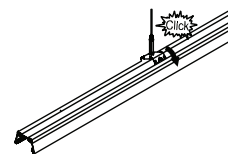

Click in mounting clip into trunking rail

Step 2
Connecting Power Supply

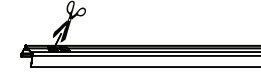

Cut the Rubber cap to pass the power cable



Screw in the conduit gland



Put in conduit with cable inside and pull up conduit gland to lock



Connect wires according labeling on wires to feed in connector then connect to connector in trunking rail

Step 3
Mounting Luminaire



Set the power on the DIP switch driver

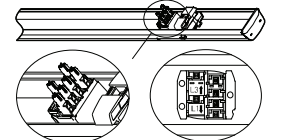

Slide knob to select phase L1/L2/L3

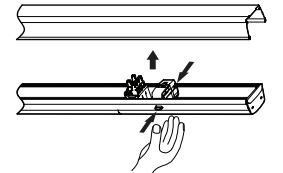

Make sure male & female connectors in right position then fix the luminaire to trunking rail



Push the sliding lock to lock the luminaire to trunking rail

Tracking and luminaire:

First trunking rail should have one side connecting plate&last trunking rail with no connecting plate on both sides , then fix the Luminaire to trunking rail then lock holder, then keep end caps at both sides.

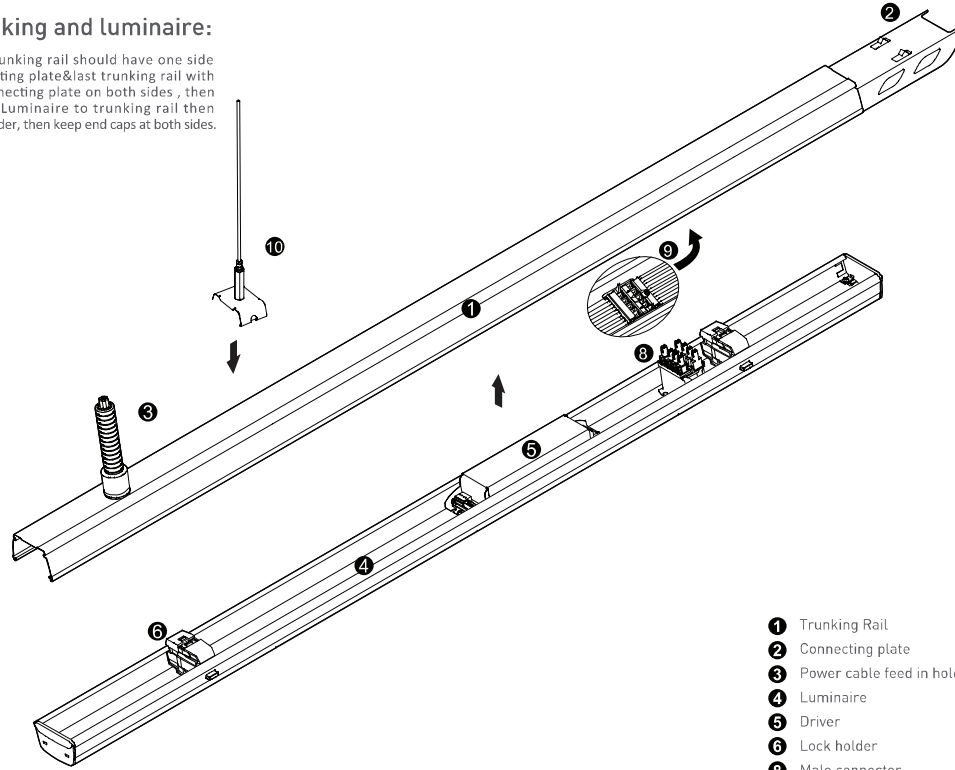

- 1 Trunking Rail
- 2 Connecting plate
- 3 Power cable feed in hole
- 4 Luminaire
- 5 Driver
- 6 Lock holder
- 8 Male connector
- 9 Female connector
- 10 Installation cord

Step 1 Mounting Suspension

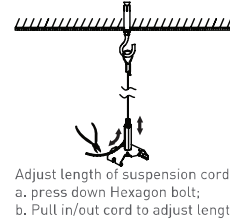

Adjust length of suspension cord:
a. press down Hexagon bolt;
b. Pull in/out cord to adjust length

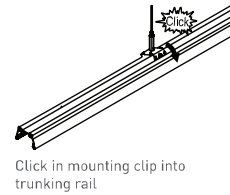

Click in mounting clip into trunking rail

Step 2 Connecting Power Supply

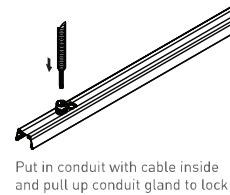

Put in conduit with cable inside and pull up conduit gland to lock



Connect wires according labeling on wires to feed in connector then connect to connector in trunking rail

Step 3 Connecting Trunking Rail

Both trunking rails should keep in perfect position then push to click

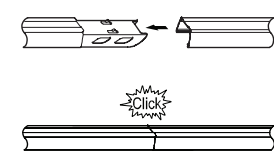

Step 4 Mounting Luminaire

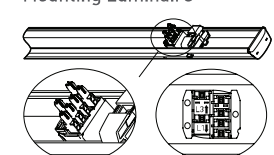

Slide knob to select phase L1/L2/L3

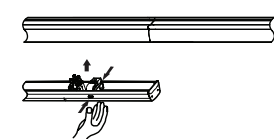

Make sure male & female connectors in right position then fix the luminaire to trunking rail

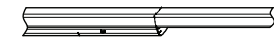

Step 5 LED linear lighting system

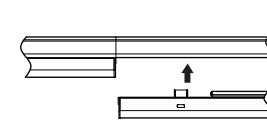

Including luminaires

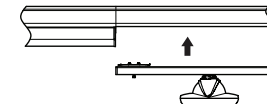

Including luminaires and sensor

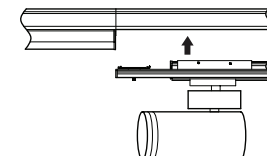

Including luminaires and spotlight

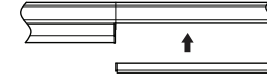

Including luminaires and black cover

Wire diagram of triple circuits function

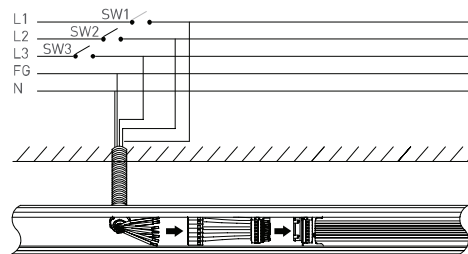

This Triple Circuits function offers to control lighting ON/OFF by three switches SW1, SW2, SW3 which are connected by live lines L1, L2, L3

Pendant and mounting installation

Starting Installation distances point should be 800 mm to 1000 mm, then in between 1st & 2nd point should be 3000 mm max

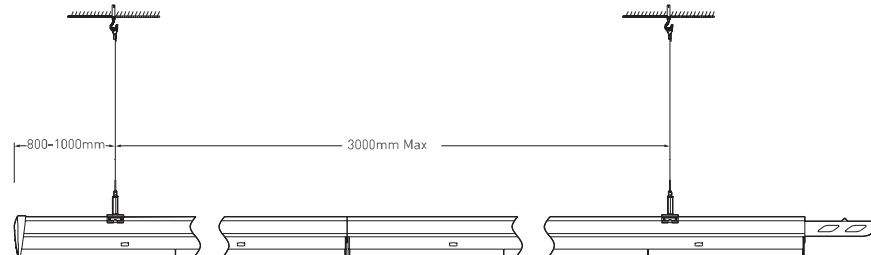

Four options for installation

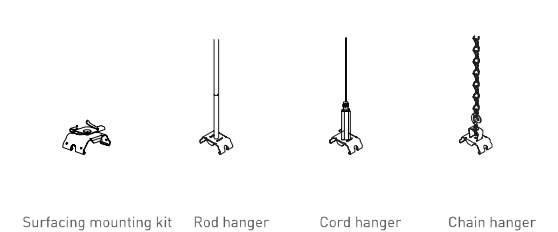

Surfacing mounting kit Rod hanger Cord hanger Chain hanger