

ART. NO.

102452-NW-02

102452-02

102452-02-ddd

102452-E-02

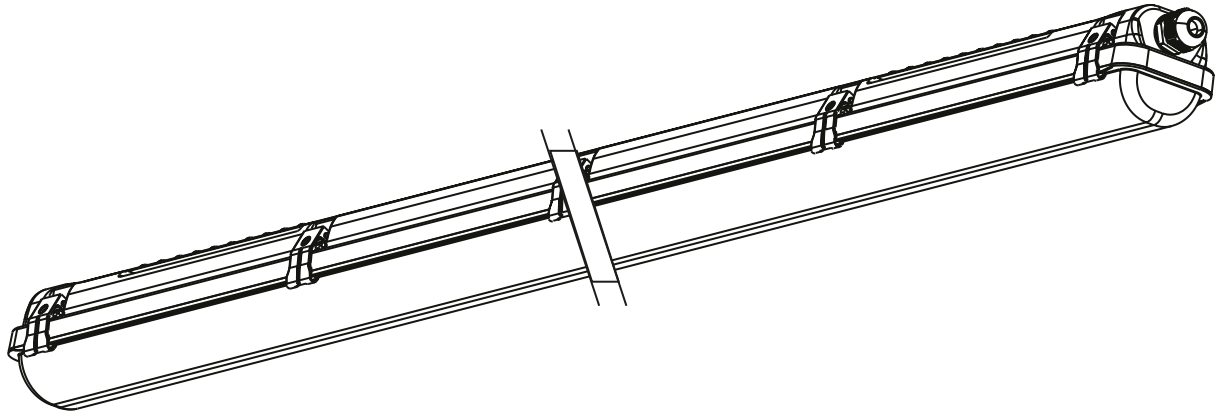
NORLUX®*Lighting Solutions*

Stream Y

INSTALLATION MANUAL

**⚠ Safety Notes:**

- The product must be installed, maintained, and operated as instructions below.
- Before starting installation of this product, make sure power supply is disconnected.
- Only to be installed by authorized electrician.
- Do not use abrasives or solvents when cleaning.
- Do not install the product if it appears damaged in any way. Check with manufacturer if in doubt.
- Do not modify this fitting in any matter as this will void warranty.
- Check protection class, if class I, it must be earthed.
- Disconnect power supply before maintenance or cleaning.

⚠ Sikkerhetsinformasjon:

- Følg installasjonsmanual for korrekt montering.
- Koble alltid fra strømmen før montering eller vedlikehold.
- Kan kun monteres av autorisert elektriker.
- Monter ikke produktet hvis det er synlig skade. Kontakt forhandler eller produsent.
- Bruk ikke løsemidler ved rengjøring
- Produktet skal ikke under noen omstendigheter endres eller modifiseres.
- Sjekk produktets isolasjonsklasse. Ved isolasjonsklasse I skal produktet jordes.

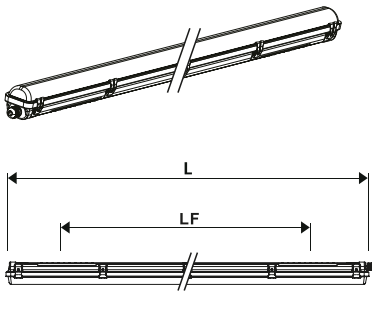

| | L | W | H | LF |
|---------------|------|----|----|------|
| 102452-02 | 1538 | 80 | 76 | 1100 |
| 102452-E-02 | 1538 | 80 | 76 | 1100 |
| 102452-02-ddd | 1538 | 80 | 76 | 1100 |

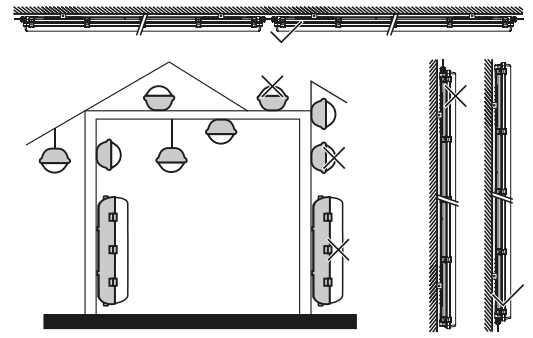

⚠ WARNING

- 1 Installation should be done by registered electricians.
- 2 Never touch the working luminaire
- 3 In any case of malfunction, switch off the power supply immediately, and do not try to repair it yourself.
- 4 Repairment should only be done by registered electricians or official service agent.

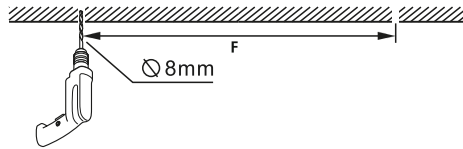

1. Drill a $\varnothing 8\text{mm}$ hole

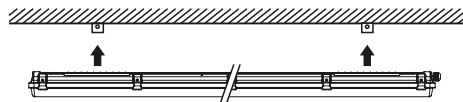

3. Fix the luminaire with the brackets

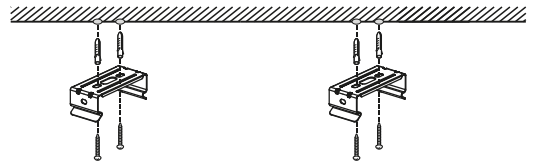

2. According to the Fixing hole centre, instal expansion bolts and screws, instal the bracket.



4. Finish installation

1

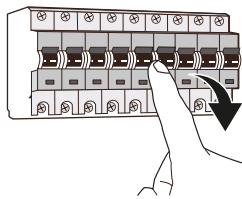

OFF

2

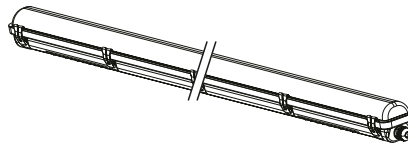

3

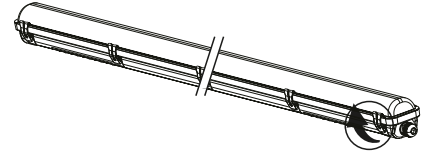

4

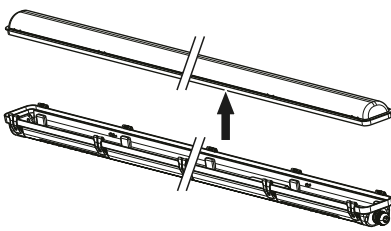

5

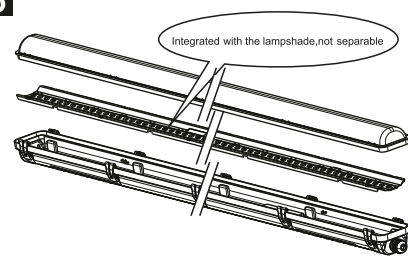

6

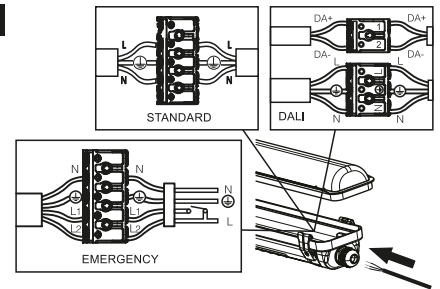

7

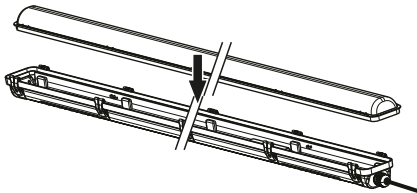

8

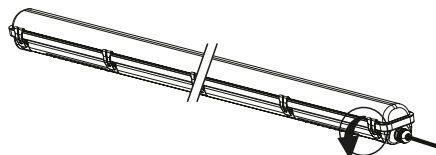

9

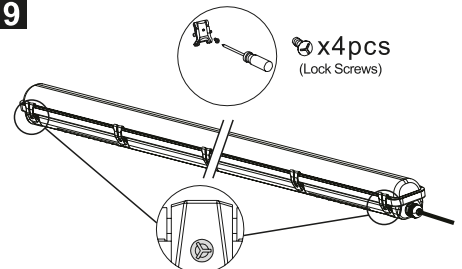

⚠ WARNING

Switch off the power supply before installation



ON

