

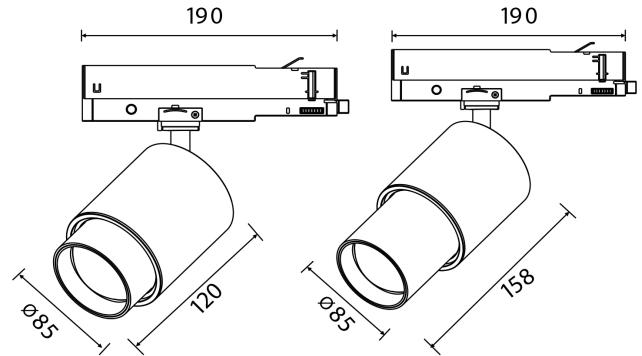

**FDV SPEC SHEET**  
Zoom Spotlight  
Art. no: 101141-660-3-ddd



## Zoom Spotlight



Art. no: 101141-660-3-ddd

### LIGHT TECHNICAL

Lightsource Type:	LED (built in)
Lumen LED (tc=25):	1750
Beam Angle:	6-60
CCT (Color Temperature):	2700
CRI / Ra:	90
Color Code:	927
MacAdam (SDCM):	3
Lens (Diffuser):	Clear

### MOUNTING / CONNECTION

Connection:	Track 3-Circuit+dim
Mounting:	Track

### ELECTRICAL DATA

Dimming:	DALI2
Flickerfree:	Yes
Flicker metric (Pst LM) <:	1
Stroboscopic effect metric (SVM) <	0,4
System Power [W]:	20
System Voltage [V]:	230V 50Hz
Dimming Output Type:	Amplitude Modulation
Protection Class:	1
Max load pr circuit - B10:	26
Max load pr circuit - B16:	42
Max load pr circuit - C10:	45
Max load pr circuit - C16:	71
Inrush current I <sub>max</sub> [A]:	35
Inrush current time [μs]:	80
Socket / Cap-Base:	N/A
Current Output [mA]:	500
Voltage Forward Min [V]:	35
Voltage Forward Max [V]:	40
Dimming Output Type:	Amplitude Modulation



## FDV SPEC SHEET

Zoom Spotlight

Art. no: 101141-660-3-ddd



*Lighting Solutions*

### PRODUCT

Ingress Protection:	IP20
Lifetime [h]:	L80B10: 55 000
Color:	White
RAL:	RAL9003
Length [mm]:	158
Diameter [mm]:	85
Weight [kg]:	1
Housing Material :	Aluminium
Housing Material :	Aluminium