



FDV SPEC SHEET

Cylinder 85
Art. no: 17158-7-45-3



Lighting Solutions

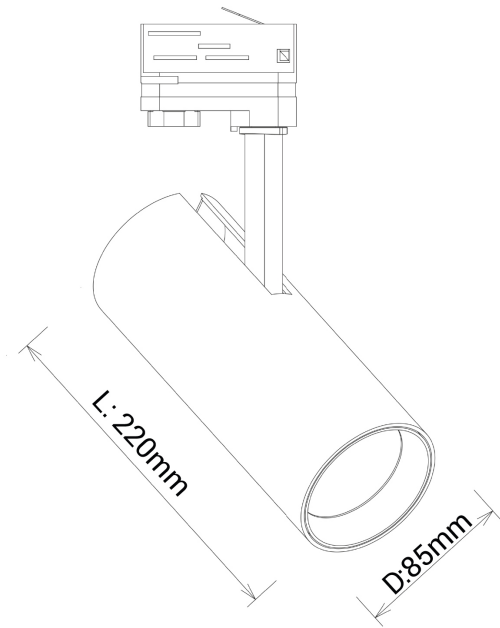

Cylinder 85



Art. no: 17158-7-45-3

LIGHT TECHNICAL

Lightsource Type:	LED (built in)
Lumen LED (tc=25):	3150
Beam Angle:	45°
CRI / Ra:	90
Lens (Diffuser):	Clear
UGR (<=):	19

MOUNTING / CONNECTION

Connection:	Track 3-Circuit
Mounting:	Track, Ceiling

PRODUCT

Ingress Protection:	IP20
Color:	White
Length [mm]:	220
Height [mm]:	250
Width [mm]:	85
Weight [kg]:	1,2

ELECTRICAL DATA

Dimming:	None
System Power [W]:	27
System Voltage [V]:	230V 50Hz
Protection Class:	1
Max load pr circuit - B10:	14
Max load pr circuit - B16:	24
Max load pr circuit - C10:	24
Max load pr circuit - C16:	40
Inrush current I _{max} [A]:	25
Inrush current time [µs]:	150
Current Output [mA]:	700