



PRODUCT SHEET

Cylinder 85

Art. no: 17158-7-45-3



Lighting Solutions

Cylinder 85

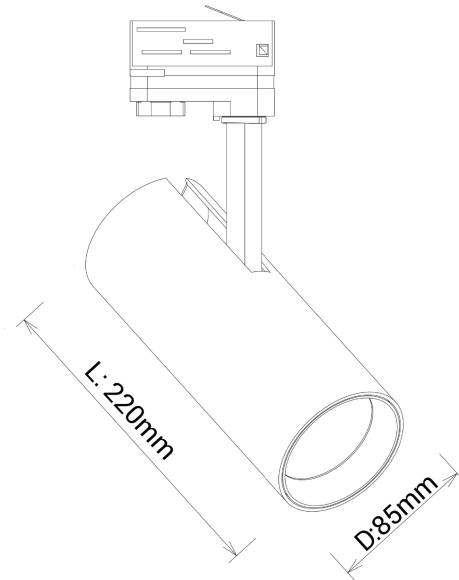

The Cylinder uses the possibilities created by new technology. The LED driver is mounted inside the luminaire body. This gives us a slim design combined with a powerful light output that can be easily adjusted in all directions to meet all needs. Cylinder can be tilted 90 degrees and rotated 350 degrees its own axis. To create further opportunities to "play" with light you can mount a diffuser on the luminaire, this can be ordered separately.



SPECIFICATIONS

Lightsource Type:	LED (built in)
System Power [W]:	27W
CRI / Ra:	90
Lumen LED (tc=25):	3150lm
Beam Angle:	45°
Lens (Diffuser):	Clear
Dimming:	None
System Voltage [V]:	230V 50Hz
Connection:	Track 3-Circuit
Mounting:	Track, Ceiling
UGR (<=):	19
Color:	White
Length [mm]:	220mm
Height [mm]:	250mm
Width [mm]:	85mm
Weight [kg]:	1,2kg