



# FDV SPEC SHEET

Trunk

Art. no: CFL-2-1535-30WD-08-3



Lighting Solutions

Unit: mm

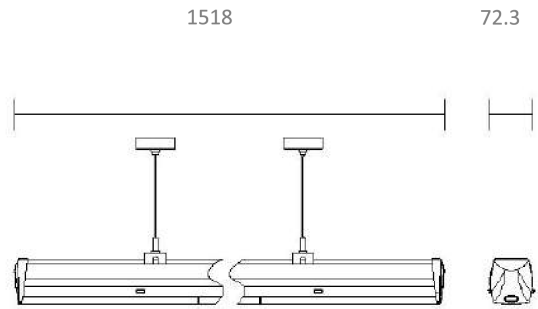

## Trunk



Art. no: CFL-2-1535-30WD-0

### LIGHT TECHNICAL

Lightsource Type:	LED (built in)
Lumen Output:	5450
Lumen LED (tc=25):	5600
Beam Angle:	90°
CCT (Color Temperature):	3000
CRI / Ra:	80
Lens (Diffuser):	Clear

### MOUNTING / CONNECTION

Connection:	Trunk 8-wires
Mounting:	Suspended, Ceiling

### ELECTRICAL DATA

Dimming:	None
Flickerfree:	Yes
System Power [W]:	35
System Voltage [V]:	230V 50Hz
Protection Class:	1



## FDV SPEC SHEET

Trunk

Art. no: CFL-2-1535-30WD-08-3



*Lighting Solutions*

### PRODUCT

Ingress Protection:	IP20
Lifetime [h]:	L80B50: 100 000
Color:	White
RAL:	RAL9016
Length [mm]:	1500
Height [mm]:	78,6
Width [mm]:	72,3
Weight [kg]:	1,64