



PRODUCT SHEET

Michelle Floodlight

Art. no: 101125-PIR-2



Lighting Solutions

Michelle Floodlight

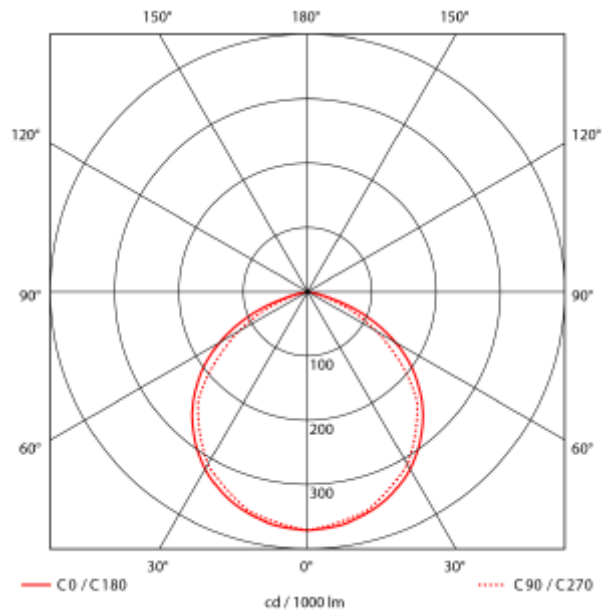
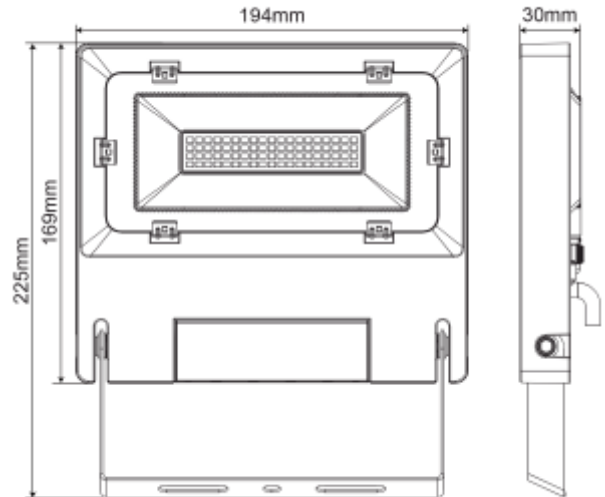

50W floodlight with PIR sensor. Use remote control to change sensor function. Choose different levels of duration time, detection sensibility, and dusk / down function.



SPECIFICATIONS

System Power [W]:	50W
CCT (Color Temperature):	4000K
CRI / Ra:	80
Lumen Output:	4950lm
Lumen LED (tc=25):	5100lm
Beam Angle:	110°
Lens (Diffuser):	Clear
Dimming:	Sensor (PIR)
System Voltage [V]:	230V 50Hz
Connection:	Cable 2m
Mounting:	Wall
Lifetime [h]:	L80B50: 35 000h
Lumen/W:	99lm/W
Color:	Black
Length [mm]:	194mm
Height [mm]:	225mm
Width [mm]:	30mm
Weight [kg]:	0,96kg