



PRODUCT SHEET

Manna Single

Art. no: 101243-40-2



Lighting Solutions

Manna Single

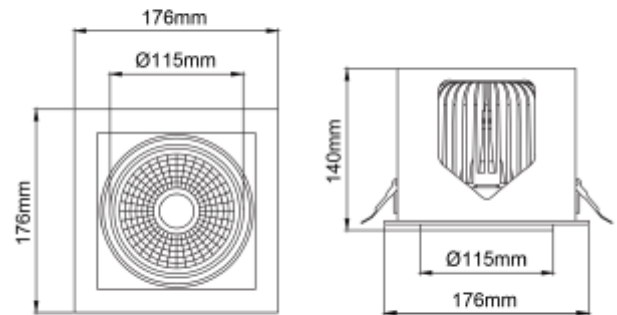

SPECIFICATIONS

Lightsource Type:	LED (built in)
System Power [W]:	35W
CCT (Color Temperature):	3500K
CRI / Ra:	90
Lumen Output:	4170lm
Lumen LED (tc=25):	4400lm
Beam Angle:	40°
Lens (Diffuser):	Clear
Dimming:	None
System Voltage [V]:	230V 50Hz
Connection:	18i3 Quick connection
Mounting:	Recessed
Cut-out [mm]:	160x160mm
Lifetime [h]:	L80B10: 60 000h
Lumen/W:	119lm/W
MacAdam (SDCM):	3
Color:	Black
Length [mm]:	176mm
Height [mm]:	140mm
Width [mm]:	176mm
To be recessed in insulation:	No

