



FDV SPEC SHEET

Cylinder 70
Art. no: 17055-7-36-2



Lighting Solutions

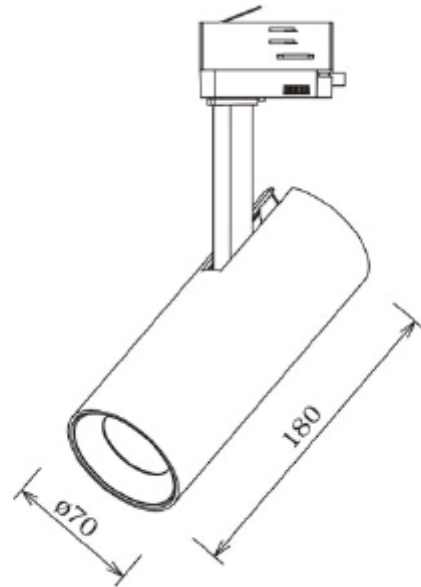

Cylinder 70



Art. no: 17055-7-36-2

LIGHT TECHNICAL

Lightsource Type:	LED (built in)
Lumen LED (tc=25):	2400
Beam Angle:	36°
CCT (Color Temperature):	3000
CRI / Ra:	90
Color Code:	930
MacAdam (SDCM):	3
Lens (Diffuser):	Clear
UGR (<=):	21

MOUNTING / CONNECTION

Connection:	Track 3-Circuit
Mounting:	Track, Ceiling

ELECTRICAL DATA

Dimming:	None
System Power [W]:	20
System Voltage [V]:	230V 50Hz
Protection Class:	1
Max load pr circuit - B10:	72
Max load pr circuit - B16:	115
Max load pr circuit - C10:	90
Max load pr circuit - C16:	144
Inrush current I _{max} [A]:	5
Inrush current time [µs]:	100
Current Output [mA]:	500
Voltage Forward Min [V]:	30,9
Voltage Forward Max [V]:	40,5



FDV SPEC SHEET

Cylinder 70

Art. no: 17055-7-36-2



Lighting Solutions

PRODUCT

Ingress Protection:	IP20
Color:	Black
Length [mm]:	180
Height [mm]:	225
Width [mm]:	70
Weight [kg]:	0,85