



PRODUCT SHEET

Ray Mini

Art. no: 18156-6-20-2



Lighting Solutions

Ray Mini

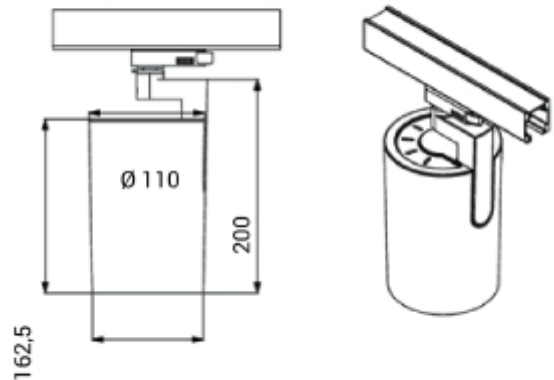

Ray Mini uses the possibilities created by new technology. The LED driver is mounted inside the luminaire body. This gives us a slim design combined with a powerful lightoutput that can be easily adjusted in all directions to meet all needs. Ray Mini can be tilted 90 degrees and rotated 350 degrees its own axis. To create further opportunities to play with light you can mount a diffuser on the luminaire, this can be ordered separately.



SPECIFICATIONS

Lightsource Type:	LED (built in)
System Power [W]:	23W
CCT (Color Temperature):	Arctic White
CRI / Ra:	95
Lumen Output:	2460lm
Lumen LED (tc=25):	2700lm
Beam Angle:	20°
Lens (Diffuser):	Clear
Dimming:	None
System Voltage [V]:	230V 50Hz
Connection:	Track 3-Circuit
Mounting:	Track, Ceiling
UGR (<=):	16
Lumen/W:	107lm/W
MacAdam (SDCM):	3
Color:	Black
Height [mm]:	200mm
Width [mm]:	110mm