



FDV SPEC SHEET

Coxa

Art. no: 2282-2



Lighting Solutions

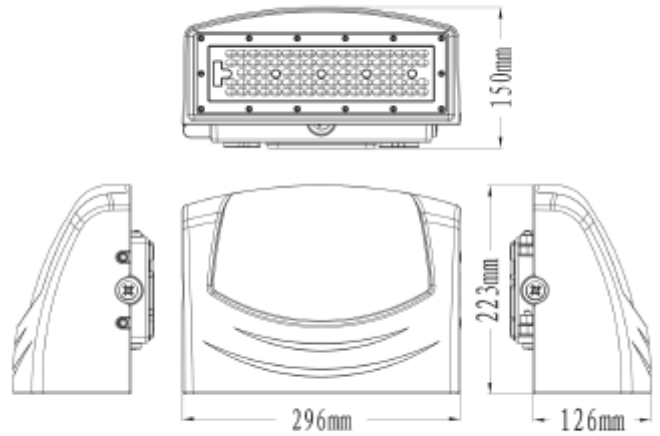

Coxa



Art. no: 2282-2

LIGHT TECHNICAL

Lightsource Type:	LED (built in)
Lumen Output:	5900
Lumen LED (tc=25):	6000
Beam Angle:	Asymmetric
CCT (Color Temperature):	4000
CRI / Ra:	70
Color Code:	740
Lens (Diffuser):	Clear

MOUNTING / CONNECTION

Connection:	Terminal
Mounting:	Surface, Wall

ELECTRICAL DATA

Dimming:	None
System Power [W]:	40
System Voltage [V]:	230V 50Hz
Protection Class:	1
Max load pr circuit - B10:	43
Max load pr circuit - B16:	64
Max load pr circuit - C10:	45
Max load pr circuit - C16:	70
Leakage current [mA]:	0,75
Inrush current I _{max} [A]:	40
Inrush current time [µs]:	450
Socket / Cap-Base:	N/A



FDV SPEC SHEET

Coxa

Art. no: 2282-2



Lighting Solutions

PRODUCT

Ingress Protection:	IP65
Impact Protection:	IK10
Corrosion Class:	C3
Operating Temperature [°C]:	-30 - 50
Lifetime [h]:	L80B10: 100 000
Color:	Black
Length [mm]:	223
Height [mm]:	296
Width [mm]:	150
Weight [kg]:	0,3