



FDV SPEC SHEET

Quadro Double
Art. no: 75201-20-2



Lighting Solutions

 280x140mm

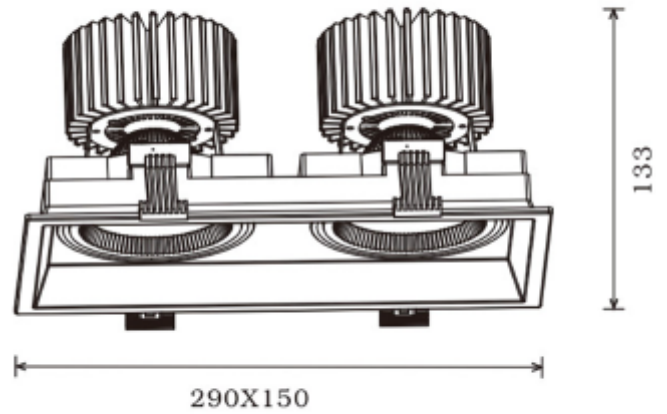

Quadro Double



Art. no: 75201-20-2

LIGHT TECHNICAL

Lumen LED (tc=25):	7500
Beam Angle:	20°
CCT (Color Temperature):	3000
CRI / Ra:	90
Color Code:	930
MacAdam (SDCM):	3
Lens (Diffuser):	Clear

MOUNTING / CONNECTION

Connection:	18i3 Quick connection
Cut-out [mm]:	280x140
Mounting:	Ceiling

ELECTRICAL DATA

Dimming:	None
System Power [W]:	2x33
System Voltage [V]:	230V 50Hz
Protection Class:	2
Max load pr circuit - B10:	14
Max load pr circuit - B16:	24
Max load pr circuit - C10:	24
Max load pr circuit - C16:	40
Inrush current I _{max} [A]:	25
Inrush current time [µs]:	150
Socket / Cap-Base:	N/A
Current Output [mA]:	800
Voltage Forward Min [V]:	30,2
Voltage Forward Max [V]:	41,7



FDV SPEC SHEET

Quadro Double

Art. no: 75201-20-2



Lighting Solutions

PRODUCT

To be recessed in insulation:	No
Ingress Protection:	IP20
Operating Temperature [°C]:	-20 - 35
Lifetime [h]:	L80B10: 50.000
Color:	Black
Length [mm]:	290
Height [mm]:	133
Width [mm]:	150
Weight [kg]:	2