

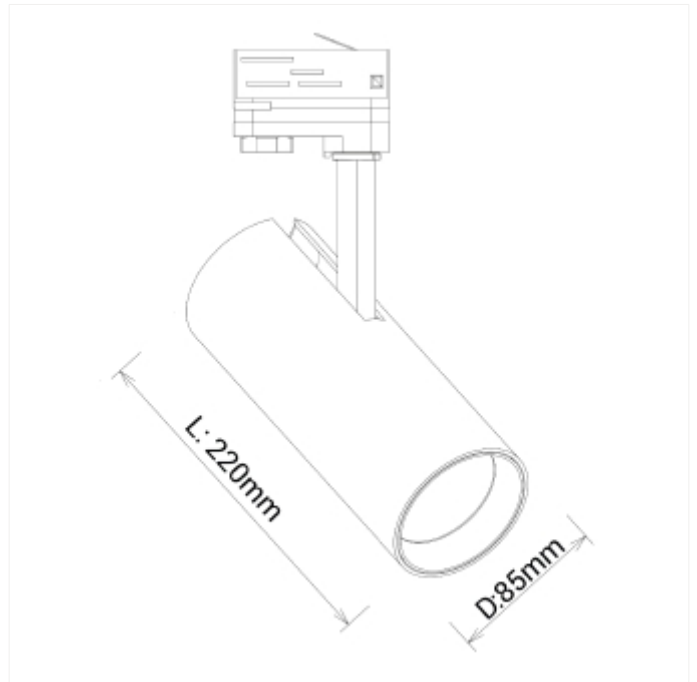

PRODUCT FAMILY SHEET
Cylinder 85



Cylinder 85

The Cylinder uses the possibilities created by new technology. The LED driver is mounted inside the luminaire body. This gives us a slim design combined with a powerful light output that can be easily adjusted in all directions to meet all needs. Cylinder can be tilted 90 degrees and rotated 350 degrees its own axis. To create further opportunities to "play" with light you can mount a diffuser on the luminaire, this can be ordered separately.

VERSIONS

Art.No	Effect [W]	Cold Lumen [lm]	Lumen Output [lm]	CCT [K]	Beam Angle [°]	Lens Difuser	CRI [>]	Color	Light Control	Connection
17158-7-30-2	27	3150		3200	30°	Clear	90	Black	None	Track 3-Circuit
17158-7-15-2	27	3150		3200	15°	Clear	90	Black	None	Track 3-Circuit
17158-7-45-3	27	3150			45°	Clear	90	White	None	Track 3-Circuit
17158-7-30-3	27	3150			30°	Clear	90	White	None	Track 3-Circuit
17155-7-15-2	27	3250	2328	3000	15°	Clear	90	Black	None	Track 3-Circuit
17155-7-15-3	27	3250	2328	3000	15°	Clear	90	White	None	Track 3-Circuit
17155-7-30-2	27	3250	2227	3000	30°	Clear	90	Black	None	Track 3-Circuit
17155-7-30-3	27	3250	2227	2700	30°	Clear	80	White	None	Track 3-Circuit
17155-7-45-2	27	3250	2279	3000	45°	Clear	90	Black	None	Track 3-Circuit
17155-7-45-3	27	3250	2279	3000	45°	Clear	90	White	None	Track 3-Circuit
17158-30-3	28	2950		Arctic White	30°	Clear	95	White	None	Track 3-Circuit