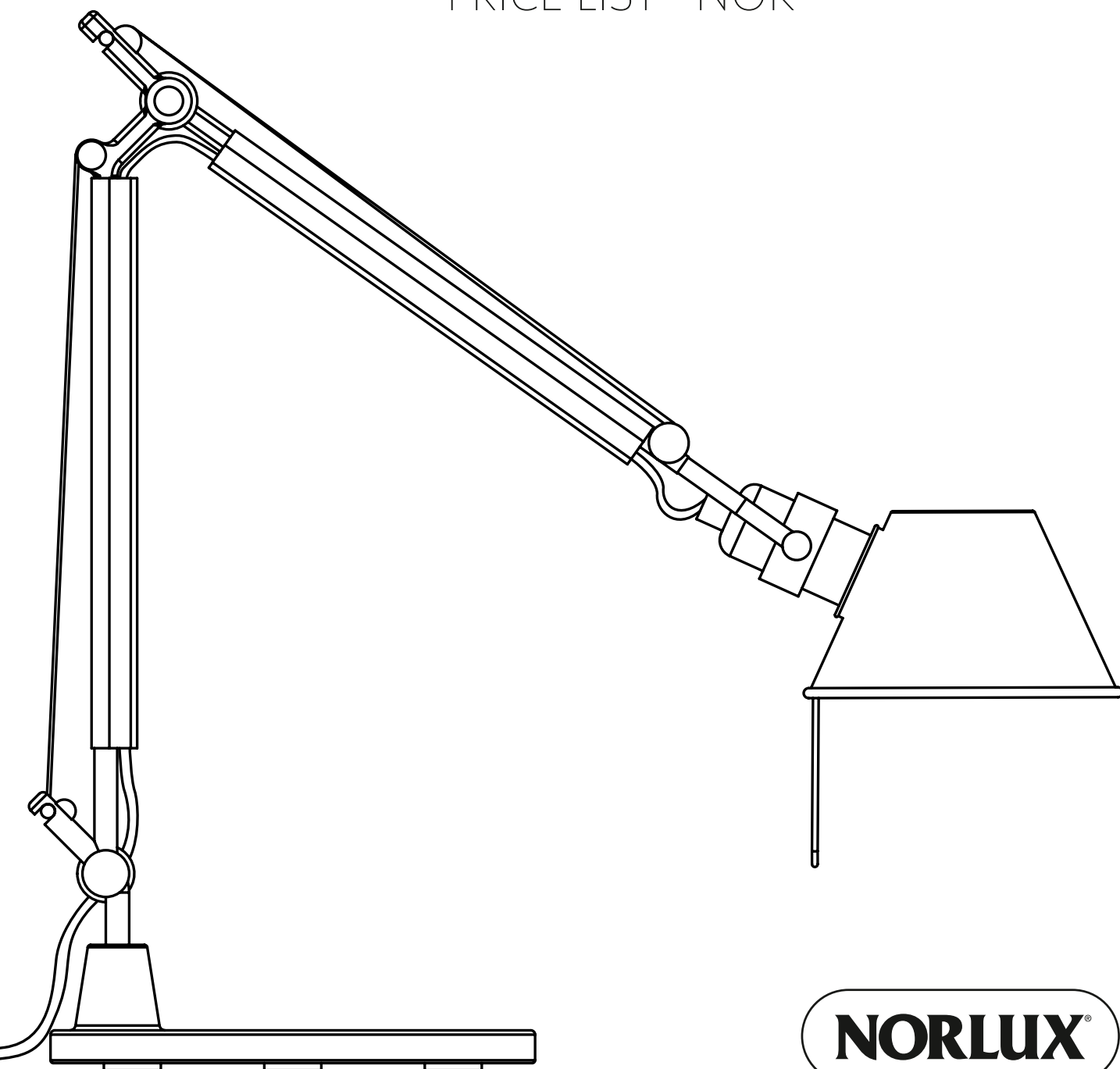


Artemide[®]

2024

PRICE LIST - NOK



NORLUX[®]

Lighting Solutions

INTEGRALIS® A UNIVERSAL LIGHT TO STAY SAFE TOGETHER

INTEGRALIS® combines sanitizing efficacy with luminous performance and design beauty.

INTEGRALIS® also integrates itself in both the environments and moments of life by interpreting the rhythms and needs of humankind.

INTEGRALIS® was born from Artemide's scientific and technological research and humanistic and social vision.

INTEGRALIS® is an innovative and a sustainable light platform aimed at a conscious and responsible use towards the environment.

PATENT PENDING

DIMMER TECHNICAL SPECIFICATION

Dimmer: dimmable fixture by means of a switch situated on the lamp structure or on cable (infrared, microswitch, push button, slider control, touch).

Dimmable: dimmable fixture by means of a remote switch (not included) able to manage dimmable sources (halogens, fluorescents, LED Retrofit).

Dimmable (Push): dimmable fixture by means of a remote switch able to manage Push Drivers.

Dimmable (1-10V): dimmable fixture by means of a remote switch able to manage 1.10V Drivers.

Dimmable (APP): dimmable fixture by means of smart devices compatible with Artemide APP – Google Play or Apple Store free download.

Dimmable (DALI): dimmable fixture by means of command points suitable for handling DALI drivers type.

Dimmable (DALI DT8): dimmable fixture by means of command points suitable for handling DALI DT8 drivers type.

Dimmable (Push /DALI): dimmable fixture by means of remote switch suitable for handling Push drivers type or, alternatively, by means of command points suitable for handling DALI drivers type. During the fixture dimming, the Push command excludes the DALI command use and vice-versa.

Dimmable (Push/APP): dimmable fixture by means both of remote switch suitable for handling Push drivers and of Artemide APP compatible smart devices - Google Play or Apple Store free download. During the fixture dimming, the Push command can coexist with APP command.

Dimmable (Push/1-10/DALI): dimmable fixture by means remote switch suitable for handling Push drivers, or, as alternate, by means command points handling 1-10 drivers or, as alternate, by means command points handling DALI drivers.

5 YEARS WARRANTY

Artemide has always provided high quality products. As a result, we are glad to inform you that from April 1st 2015 we will offer to all our end users worldwide (private consumers only) a free 5-year extended warranty, valid only if the product is successfully registered online within two months from the date of purchase.

Conditions for the 5-year extended warranty are as follows:

- Being an end user (private consumer);
- Purchasing the Artemide product after April 1st 2015;
- Registering the product online within 2 months from the date of purchase;
- The product must be new (not second-hand);
- Being the first owner of the product (the warranty is not transferable).

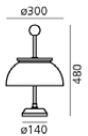



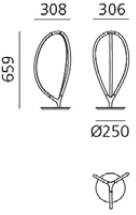
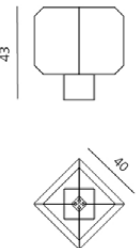

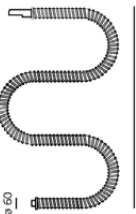
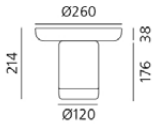
Following successful online activation and claim, the extended warranty will entitle the private customer to a free repair or replacement when the product is determined to be faulty due to manufacturing defect, as stated on its terms and conditions. For further information please go to: cloud.artemide.com/5-years-warranty

TYOLOGY

PAGES

TABLE LAMPS	5-19
FLOOR LAMPS	19-30
SUSPENSION LAMPS	30-60
WALL / CEILING LAMPS	60-85
ARTEMIDE OUTDOOR	86-103

TABLE LAMPS

		Code	Veil Pris NOK eks mva	Veil Pris NOK ink mva	
	<p>ALFA Sergio Mazza Table lamp</p> <p>IP 20 LED DIM 2x6W (E14)  Dimmer</p> <p>Materials: glass, steel, marble</p>	0026010A	12.200,58	15.250,73	
	<p>AMAMI Naoto Fukasawa Table lamp</p> <p>IP 20 LED 1x8W (E27)  Materials: ABS</p>	DANESSE MILANO DX0110A00	2.354,63	2.943,28	white
	<p>ARRIVAL TABLE Ludovica+Roberto Palomba Table lamp</p> <p>IP 20 LED Strip 3000K, 17W, 555lm, CRI=90 Dimmer</p> <p>Materials: aluminum, silicone, steel</p>	1550010A	12.451,74	15.564,68	gold
		1550030A	12.451,74	15.564,68	black matt
	<p>BALI TABLE Bruno Munari Table lamp</p> <p>IP 20 LED DIM 1x8W (E27)  Materials: bamboo fiber with elastene, steel, aluminum, light walnut plywood and brass</p>	DANESSE MILANO DM2003C00	2.801,40	3.501,75	brass
		DM2003C00	2.801,40	3.501,75	silver
	<p>BOALUM LED Livio Castiglioni, Gianfranco Frattini Table lamp</p> <p>IP 20 LED 2700K, 20W, 780lm, CRI=90 Materials: PVC</p>	0027110A	12.712,56	15.890,70	white flexible structure
	<p>BONTA' (lamp + plate) Davide Oldani, Attila Veress Mobile table lamp</p> <p>IP 20 LED 2700K, 2,4W, 242lm, CRI=80 USB recharge</p> <p>Materials: blown glass, zamak</p>	0150140A	8.867,88	11.084,85	lamp + red glass plate
		0150150A	8.867,88	11.084,85	lamp + topaz glass plate
		0150160A	8.867,88	11.084,85	lamp + turquoise glass plate
		0150170A	8.867,88	11.084,85	lamp + grey glass plate
					three light intensities

NEW

TABLE LAMPS

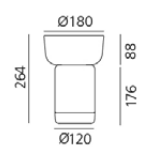
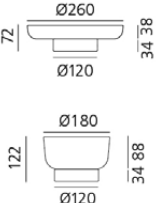
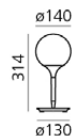

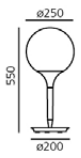



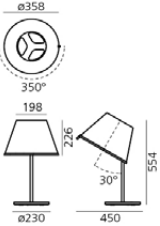


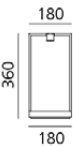
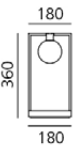
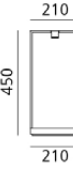


 <p>BONTA' (lamp + bowl) Davide Oldani, Attila Veress Mobile table lamp</p> <p>IP 20 LED 2700K, 2,4W, 242lm, CRI=80 USB recharge</p> <p>Materials: blown glass, zamak</p>	0150240A	8.244,81	10.306,01	lamp + red glass bowl
	0150250A	8.244,81	10.306,01	lamp + topaz glass bowl
	0150260A	8.244,81	10.306,01	lamp + turquoise glass bowl
	0150270A	8.244,81	10.306,01	lamp + grey glass bowl
				three light intensities
 <p>BONTA' (accessories) Davide Oldani, Attila Veress Mobile table lamp</p> <p>Materials: blown glass, elm wood</p>	0150340A	3.381,00	4.226,25	accessory: wood base + red glass plate
	0150350A	3.381,00	4.226,25	accessory: wood base + topaz glass plate
	0150360A	3.381,00	4.226,25	accessory: wood base + turquoise glass plate
	0150370A	3.381,00	4.226,25	accessory: wood base + grey glass plate
	0150440A	2.922,15	3.652,69	accessory: wood base + red glass bowl
	0150450A	2.922,15	3.652,69	accessory: wood base + topaz glass bowl
	0150460A	2.922,15	3.652,69	accessory: wood base + turquoise glass bowl
	0150470A	2.922,15	3.652,69	accessory: wood base + grey glass bowl
 <p>CASTORE 14 TABLE Michele De Lucchi, Huub Ubbens Table lamp</p> <p>IP 20 LED 1x5W (E14) </p> <p>Materials: blown glass, polycarbonate, zamak</p>	1044110A	2.250,78	2.813,48	white
 <p>CASTORE 25 TABLE Michele De Lucchi, Huub Ubbens Table lamp</p> <p>IP 20 LED DIM 1x13W (E27)  Dimmer</p> <p>Materials: blown glass, polycarbonate, zamak</p>	1050010A	4.714,08	5.892,60	white
 <p>CASTORE 35 TABLE Michele De Lucchi, Huub Ubbens Table lamp</p> <p>IP 20 LED DIM 1x21W (E27)  Dimmer</p> <p>Materials: blown glass, polycarbonate, zamak</p>	1049010A	6.815,13	8.518,91	white
 <p>CHOOSE TABLE Matteo Thun Table lamp</p> <p>IP 20 LED 1x8W (E27) </p> <p>Materials: polycarbonate, parchment paper, steel, zamak</p>	1128020A	4.863,81	6.079,76	parchment paper diffuser, structure anthracite grey
	1128110A	5.945,73	7.432,16	diffuser white, structure chrome
	1128120A	5.945,73	7.432,16	parchment paper diffuser, structure chrome

TABLE LAMPS

 <p>COME TOGETHER Carlotta de Bevilacqua Mobile table lamp</p> <p>IP 20 LED 2700K, 2,4W, 282lm, CRI=80 USB recharge</p> <p>LED 2700K, 2,4W, 280lm, CRI=80 USB recharge</p> <p>LED 2700K, 2,4W, 272lm, CRI=80 USB recharge</p> <p>Materials: methacrylate</p>	0165W10A	2.511,60	3.139,50	2700K: white
	0165W20A	2.922,15	3.652,69	2700K: aluminium
	0165W30A	2.922,15	3.652,69	2700K: copper
				three light intensities
 <p>CURIOSITY 36 / FOCUS Davide Oppizzi Table lamp</p> <p>IP 20 LED 3000K, 1,7W, 163lm, CRI=90 USB recharge</p> <p>LED 3000K, 1,7W, 148lm, CRI=90 USB recharge</p> <p>Materials: aluminum</p>	0174010A	3.694,95	4.618,69	36: black
	0174110A	3.694,95	4.618,69	36 FOCUS: black
				three light intensities
 <p>CURIOSITY 36 sphere Davide Oppizzi Table lamp</p> <p>IP 20 LED 3000K, 1,7W, 142lm, CRI=90 USB recharge</p> <p>Materials: aluminum</p>	0175010A	4.404,96	5.506,20	black structure with white sphere Ø 100mm
				three light intensities
 <p>CURIOSITY 45 / FOCUS Davide Oppizzi Table lamp</p> <p>IP 20 LED 3000K, 2,5W, 234lm, CRI=90 USB recharge</p> <p>LED 3000K, 2,5W, 214lm, CRI=90 USB recharge</p> <p>Materials: aluminum</p>	0176010A	4.974,90	6.218,63	45: black
	0176110A	4.974,90	6.218,63	45 FOCUS: black
				three light intensities
 <p>DALU' Vico Magistretti Table lamp</p> <p>IP 20 LED 1x6W (E14) </p> <p>Materials: polycarbonate</p>	1466000A	1.130,22	1.412,78	white
	1466030A	1.130,22	1.412,78	black
	1466070A	1.130,22	1.412,78	orange

Code	Veil Pris NOK eks mva	Veil Pris NOK ink mva
------	-----------------------------	-----------------------------

TABLE LAMPS

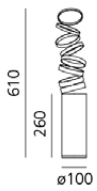



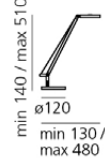
 <p>DECOMPOSE' LIGHT TABLE Atelier Oi Table lamp</p> <p>IP 20 LED 1x8W (E27) </p> <p>Materials: aluminum</p>	DOI4600C03	4.105,50	5.131,88	orange
	DOI4600C80	4.105,50	5.131,88	smoked
	DOI4600C02	4.105,50	5.131,88	gold
	DOI4600C16	4.105,50	5.131,88	red
 <p>DEMETRA TABLE Naoto Fukasawa Table lamp</p> <p>IP 20 LED 2700K, 8W, 360lm, CRI=90 Dimmer</p> <p>LED 3000K, 8W, 385lm, CRI=90 Dimmer</p> <p>Materials: aluminum, technopolymer, steel</p>	1734W10A	3.844,68	4.805,85	body lamp 2700K anthracite grey
	1734010A	3.844,68	4.805,85	body lamp 3000K anthracite grey
	1734W20A	3.844,68	4.805,85	body lamp 2700K white
	1734020A	3.844,68	4.805,85	body lamp 3000K white
	1734W50A	3.844,68	4.805,85	body lamp 2700K opaque black
	1734050A	3.844,68	4.805,85	body lamp 3000K opaque black
	1735010A	4.255,23	5.319,04	body 3000K w/presence detector, anthracite grey
	1735020A	4.255,23	5.319,04	body 3000K w/presence detector, white
	1735050A	4.255,23	5.319,04	body 3000K w/presence detector, opaque black
	1733010A	1.019,13	1.273,91	table base anthracite grey
	1733020A	1.019,13	1.273,91	table base white
	1733050A	1.019,13	1.273,91	table base opaque black
	1743010A	410,55	513,19	desk fixed support anthracite grey
	1743020A	410,55	513,19	desk fixed support white
	1743050A	410,55	513,19	desk fixed support opaque black
	1744010A	458,85	573,56	table clamp anthracite grey
	1744020A	458,85	573,56	table clamp white
	1744050A	458,85	573,56	table clamp opaque black
				Complete lamp consists of 2 items.
	 <p>DEMETRA PROFESSIONAL TABLE Naoto Fukasawa Table lamp</p> <p>IP 20 LED 3000K, 12W, 960lm, CRI=90 Dimmer</p> <p>Materials: aluminum, technopolymer, steel</p>	1739010A	5.023,20	6.279,00
1739020A		5.023,20	6.279,00	body lamp, white
1739050A		5.023,20	6.279,00	body lamp, opaque black
1740010A		5.535,18	6.918,98	body w/presence detector, anthracite grey
1740020A		5.535,18	6.918,98	body w/presence detector, white
1740050A		5.535,18	6.918,98	body w/presence detector, opaque black
1733010A		1.019,13	1.273,91	table base anthracite grey
1733020A		1.019,13	1.273,91	table base white
1733050A		1.019,13	1.273,91	table base opaque black
1744010A		458,85	573,56	table clamp anthracite grey
1744020A		458,85	573,56	table clamp white
1744050A		458,85	573,56	table clamp opaque black
1743010A		410,55	513,19	desk fixed support anthracite grey
1743020A		410,55	513,19	desk fixed support white
1743050A		410,55	513,19	desk fixed support opaque black
			Complete lamp consists of 2 items.	
 <p>DEMETRA MICRO TABLE Naoto Fukasawa Table lamp</p> <p>IP 20 LED 2700K, 6W, 241lm, CRI=90 Dimmer</p> <p>LED 3000K, 6W, 257lm, CRI=90 Dimmer</p> <p>Materials: aluminum, technopolymer, zamac</p>	1747W10A	3.023,58	3.779,48	body lamp 2700K and base anthracite grey
	1747010A	3.023,58	3.779,48	body lamp 3000K and base anthracite grey
	1747W20A	3.023,58	3.779,48	body lamp 2700K and base white
	1747020A	3.023,58	3.779,48	body lamp 3000K and base white
	1747W50A	3.023,58	3.779,48	body lamp 2700K and base opaque black
	1747050A	3.023,58	3.779,48	body lamp 3000K and base opaque black

TABLE LAMPS





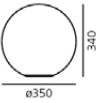






		Code	Veil Pris NOK eks mva	Veil Pris NOK ink mva	
 <p>DIOSCURI 14 TABLE Michele De Lucchi Table lamp</p> <p>IP 20 LED 1x5W (E14) </p> <p>Materials: blown glass, polycarbonate, steel</p>	1034110A	1.840,23	2.300,29	white	
 <p>DIOSCURI 25 TABLE Michele De Lucchi Table lamp</p> <p>IP 20 LED DIM 1x13W (E27)  Dimmer</p> <p>Materials: blown glass, polycarbonate, steel</p>	0146010A	3.332,70	4.165,88	white	
 <p>DIOSCURI 35 TABLE Michele De Lucchi Table lamp</p> <p>IP 20 LED DIM 1x21W (E27)  Dimmer</p> <p>Materials: blown glass, polycarbonate, steel</p>	0147010A	4.202,10	5.252,63	white	
 <p>DIOSCURI 42 TABLE Michele De Lucchi Table lamp</p> <p>IP 20 LED DIM 1x21W (E27)  Dimmer</p> <p>Materials: blown glass, polycarbonate, steel</p>	0254010A	5.684,91	7.106,14	white	
 <p>ECLISSE Vico Magistretti Table/wall lamp</p> <p>IP 20 LED 1x5W (E14) </p> <p>Materials: steel, technopolymer</p>	0028010A	2.101,05	2.626,31	white	
	0028050A	2.101,05	2.626,31	orange	
	0028030A	2.101,05	2.626,31	red	
	0028040A	2.101,05	2.626,31	yellow	
	0028130A	2.402,93	3.003,66	black PVD	
	0028140A	2.402,93	3.003,66	mirror PVD	
	0028150A	2.402,93	3.003,66	gold PVD	
	0028170A	2.402,93	3.003,66	copper PVD	
 <p>EMPATIA 16 TABLE Carlotta de Bevilacqua, Paola di Arianello Table lamp</p> <p>IP 20 LED 3000K, 11W, 567lm, CRI=90 Dimmer</p> <p>Materials: blown glass, methacrylate, aluminum</p>	1813010A	7.945,35	9.931,69	transparent smoked diffuser, white structure	

TABLE LAMPS



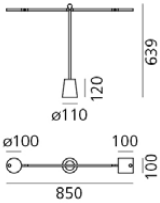
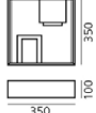

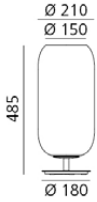

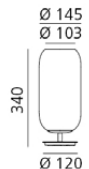

 <p>EMPATIA 26 TABLE Carlotta de Bevilacqua, Paola di Arianello Table lamp</p> <p>IP 20 LED 3000K, 20W, 710lm, CRI=90 Dimmer</p> <p>Materials: blown glass, methacrylate, aluminum</p>	1817010A	11.427,78	14.284,73	transparent smoked diffuser, white structure
 <p>EMPATIA 36 TABLE Carlotta de Bevilacqua, Paola di Arianello Table lamp</p> <p>IP 20 LED 3000K, 26W, 1273lm, CRI=90 Dimmer</p> <p>Materials: blown glass, methacrylate, aluminum</p>	1821010A	14.649,39	18.311,74	transparent smoked diffuser, white structure
 <p>EQUILIBRIST Jean Nouvel Table lamp</p> <p>IP 20 LED 3000K, 12W, CRI=90 240lm round head, 380lm square head Dimmer</p> <p>Materials: aluminum, zamac</p>	1442010A	8.505,63	10.632,04	black
 <p>FATO Gio Ponti Table/wall lamp</p> <p>IP 20 LED 2x5W (E14) </p> <p>Materials: steel</p>	0048010A	4.202,10	5.252,63	white
	0048050A	4.516,05	5.645,06	gold
 <p>GOPLE TABLE BIG Table lamp</p> <p>IP 20 LED DIM 1x17W (E27) </p> <p>Dimmer</p> <p>Materials: aluminum, white blown glass with nuances or blown glass with PVD treatment</p>	1408010A	10.143,00	12.678,75	structure and diffuser silver PVD
	1408020A	8.916,18	11.145,23	silver structure and nuanced white diffuser
	1408040A	10.143,00	12.678,75	silver structure and copper diffuser PVD
	1408050A	10.143,00	12.678,75	silver structure and blue sapphire diffuser PVD
	1408060A	10.143,00	12.678,75	silver structure and bronze diffuser PVD
	1408220A	8.708,49	10.885,61	white structure and nuanced white diffuser
	1408340A	10.034,33	12.542,91	black structure and copper diffuser PVD
	1408350A	10.034,33	12.542,91	black structure and blue sapphire diffuser PVD
	1408360A	10.034,33	12.542,91	black structure and bronze diffuser PVD
 <p>GOPLE MINI TABLE BIG Table lamp</p> <p>IP 20 LED 1x5W (E14) </p> <p>Materials: aluminum, white blown glass with nuances or blown glass with PVD treatment</p>	1409010A	6.013,35	7.516,69	structure and diffuser silver PVD
	1409020A	5.385,45	6.731,81	silver structure and nuanced white diffuser
	1409040A	6.013,35	7.516,69	silver structure and copper diffuser PVD
	1409050A	6.013,35	7.516,69	silver structure and blue sapphire diffuser PVD
	1409060A	6.013,35	7.516,69	silver structure and bronze diffuser PVD
	1409220A	5.274,36	6.592,95	white structure and nuanced white diffuser
	1409340A	5.904,68	7.380,84	black structure and copper diffuser PVD
	1409350A	5.904,68	7.380,84	black structure and blue sapphire diffuser PVD
	1409360A	5.904,68	7.380,84	black structure and bronze diffuser PVD

TABLE LAMPS




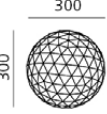
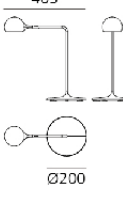
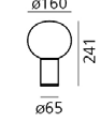

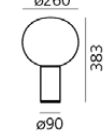



 <p>Ø130 267</p>	<p>GOPLE PORTABLE BIG Mobile table lamp</p> <p>IP 20 LED 2700K, 2,4W, 212lm, CRI=80 USB recharge</p> <p>Materials: methacrylate</p>	<p>0181020A</p>	<p>3.120,18</p>	<p>3.900,23</p>	<p>white diffuser three light intensities</p>
 <p>Ø130 267</p>	<p>GOPLE PLUG BIG Table lamp</p> <p>IP 20 LED 1x5W (E14) </p> <p>Materials: methacrylate</p>	<p>0180020A</p>	<p>1.840,23</p>	<p>2.300,29</p>	<p>white diffuser</p>
 <p>300 300</p>	<p>HUARA Elemental Table lamp</p> <p>IP 20 LED 3000K, 47W, 161lm, CRI=80 Dimmer</p> <p>Materials: methacrylate</p>	<p>0160010APP</p>	<p>60.819,36</p>	<p>76.024,20</p>	<p>black</p>
 <p>424 403 Ø200</p>	<p>IXA Foster + Partners Table lamp</p> <p>IP20 LED 3000K, 9W, 465lm, CRI=90 Dimmer</p> <p>Materials: aluminum, steel, technopolymer</p>	<p>1110010A 1110020A 1110030A 1110040A 1110050A</p>	<p>5.583,48 5.583,48 5.583,48 5.583,48 5.583,48</p>	<p>6.979,35 6.979,35 6.979,35 6.979,35 6.979,35</p>	<p>anthracite white/grey blue yellow red</p> <p style="text-align: right;">NEW</p>
 <p>Ø160 241 Ø65</p>	<p>LAGUNA 16 TABLE Matteo Thun, Antonio Rodriguez Table lamp</p> <p>IP 20 LED 1x8W (E14) </p> <p>Materials: blown glass, aluminum</p>	<p>1800140A 1800160A</p>	<p>3.791,55 3.791,55</p>	<p>4.739,44 4.739,44</p>	<p>transparent smoked diffuser, brass satinised structure transparent smoked diffuser, bronze satinised structure</p>
 <p>Ø260 383 Ø90</p>	<p>LAGUNA 26 TABLE Matteo Thun, Antonio Rodriguez Table lamp</p> <p>IP 20 LED DIM 1x20W (E27) </p> <p>Dimmer</p> <p>Materials: blown glass, aluminum</p>	<p>1805140A 1805160A</p>	<p>5.796,00 5.796,00</p>	<p>7.245,00 7.245,00</p>	<p>transparent smoked diffuser, brass satinised structure transparent smoked diffuser, bronze satinised structure</p>
 <p>Ø370 541 Ø130</p>	<p>LAGUNA 37 TABLE Matteo Thun, Antonio Rodriguez Table lamp</p> <p>IP 20 LED DIM 1x20W (E27) </p> <p>Dimmer</p> <p>Materials: blown glass, aluminum</p>	<p>1809140A 1809160A</p>	<p>8.409,03 8.409,03</p>	<p>10.511,29 10.511,29</p>	<p>transparent smoked diffuser, brass satinised structure transparent smoked diffuser, bronze satinised structure</p>

TABLE LAMPS

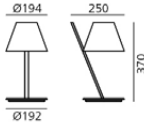

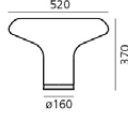

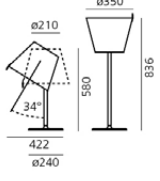

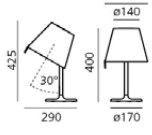

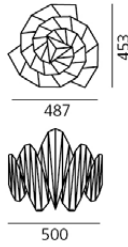



		Code	Veil Pris NOK eks mva	Veil Pris NOK ink mva	
 <p>LA PETITE Andrea Quaglio, Manuela Simonelli Table lamp</p> <p>IP 20 LED 1x5W (E14) </p> <p>Materials: polycarbonate, aluminum, methacrylate</p>	1751020A	2.415,00	3.018,75	white	
	1751030A	2.415,00	3.018,75	black	
 <p>LESBO Angelo Mangiarotti Table lamp</p> <p>IP 20 LED DIM 1x15W (E27)  Dimmer</p> <p>Materials: blown glass, aluminum</p>	0054010A	13.992,51	17.490,64	smoked white diffuser	
 <p>MELAMPO TABLE Adrien Gardère Table lamp</p> <p>IP 20 LED 2x17W (E27) </p> <p>Materials: technopolymer, silk satin, aluminum, zamac</p>	0315010A	4.974,90	6.218,63	structure and diffuser grey	
	0315020A	4.974,90	6.218,63	structure bronze, diffuser neutral	
 <p>MELAMPO NOTTE Adrien Gardère Table lamp</p> <p>IP 20 LED 1x5W (E14) </p> <p>Materials: technopolymer, silk satin, aluminum, zamac</p>	0710010A	2.873,85	3.592,31	structure and diffuser grey	
	0710020A	2.873,85	3.592,31	structure bronze, diffuser neutral	
 <p>MENDORI Issey Miyake + Reality Lab IN-EI table lamp</p> <p>IP 20 LED 3000K, 8W, 425lm, CRI=80 Dimmer</p> <p>Materials: recycled PET, methacrylate, aluminum, steel</p>	 1692010A	10.756,41	13.445,51	white	
 <p>METEORITE 15 TABLE Pio e Tito Toso Table lamp</p> <p>IP 20 LED 1x5W (E14) </p> <p>Materials: blown glass, technopolymer, steel</p>	1703110A	2.250,78	2.813,48	white	

TABLE LAMPS

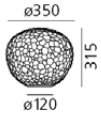

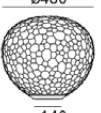



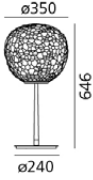



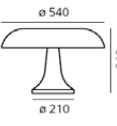



	<p>METEORITE 35 TABLE Pio e Tito Toso Table lamp</p> <p>IP 20 LED DIM 1x21W (E27)  Dimmer</p> <p>Materials: blown glass, technopolymer, steel</p>	1700010A	4.762,38	5.952,98	white
	<p>METEORITE 48 TABLE Pio e Tito Toso Table lamp</p> <p>IP 20 LED DIM 1x21W (E27)  Dimmer</p> <p>Materials: blown glass, technopolymer, steel</p>	1711010A	7.887,39	9.859,24	white
	<p>METEORITE 15 TABLE STEM Pio e Tito Toso Table lamp</p> <p>IP 20 LED 1x5W (E14)  Dimmer</p> <p>Materials: blown glass, technopolymer, aluminum, steel</p>	1709110A	3.844,68	4.805,85	diffuser white, structure chrome
	<p>METEORITE 35 TABLE STEM Pio e Tito Toso Table lamp</p> <p>IP 20 LED DIM 1x21W (E27)  Dimmer</p> <p>Materials: blown glass, technopolymer, steel</p>	1705010A	8.766,45	10.958,06	diffuser white, structure chrome
	<p>MEZZACHIMERA Vico Magistretti Table/floor lamp</p> <p>IP 20 LED 3x9W (E27)  Dimmer</p> <p>Materials: methacrylate, aluminum</p>	0055010A	7.785,96	9.732,45	white
	<p>NESSO Giancarlo Mattioli, Gruppo Architetti Urbanisti Città Nuova Table lamp</p> <p>IP 20 LED 4x5W (E14)  Dimmer</p> <p>Materials: polycarbonate</p>	0056010A	3.791,55	4.739,44	white
		0056050A	3.791,55	4.739,44	orange
	<p>NESSINO Giancarlo Mattioli, Gruppo Architetti Urbanisti Città Nuova Table lamp</p> <p>IP 20 LED 4x5W (E14)  Dimmer</p> <p>Materials: polycarbonate</p>	0039060A	2.052,75	2.565,94	white
		0039070A	2.052,75	2.565,94	orange
		0039080A	2.052,75	2.565,94	red

TABLE LAMPS

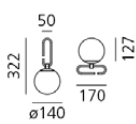







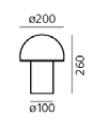

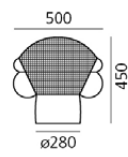

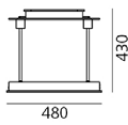
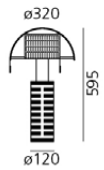

	Code	Veil Pris NOK eks mva	Veil Pris NOK ink mva	
 <p>nh 1217 Neri&Hu Table lamp</p> <p>IP 20 LED 1x5W (E14) </p> <p>Materials: blown glass, brass</p>	1217010A	2.415,00	3.018,75	white diffuser, brushed brass base
 <p>ONFALE GRANDE Luciano Vistosi Table lamp</p> <p>IP 20 LED 1x13W (E27)  + LED 1x5W (E14) </p> <p>Materials: blown glass</p>	A006300	9.988,44	12.485,55	white switched separately on/off
 <p>ONFALE MEDIO Luciano Vistosi Table lamp</p> <p>IP 20 LED 1x6W (E14)  + LED 1x5W (E14) </p> <p>Materials: blown glass</p>	A006500	7.423,71	9.279,64	white switched separately on/off
 <p>ONFALE PICCOLO Luciano Vistosi Table lamp</p> <p>IP 20 LED 1x6W (E14) </p> <p>Materials: blown glass</p>	A006400	4.255,23	5.319,04	white
 <p>PATROCLO Gae Aulenti Table lamp</p> <p>IP 20 LED DIM 1x15W (E27)  Dimmer</p> <p>Materials: blown glass, steel</p>	0060010A	13.944,21	17.430,26	fumé transparent
 <p>PAUSANIA TW Ettore Sottsass Table lamp</p> <p>IP 20 LED 2700-6500K, 14W, 690lm, CRI=80 Dimmer</p> <p>Materials: methacrylate, brass</p>	1081010A	13.171,41	16.464,26	diffuser green/black, chromed stems, black base
 <p>SHOGUN Mario Botta Table lamp</p> <p>IP 20 LED 1x8W (E27) </p> <p>Materials: aluminum, steel</p>	A000300	8.655,36	10.819,20	white diffuser, white/black base

TABLE LAMPS

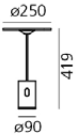

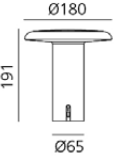
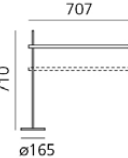
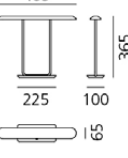
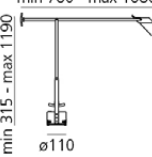


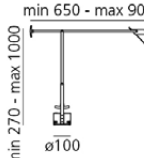

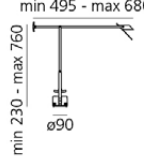

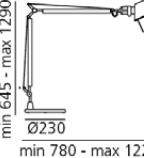

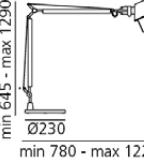
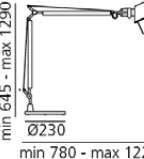
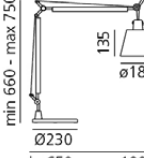

	<p>SISIFO Scott Wilson Table lamp</p> <p>IP 20 LED 3000K, 14W, 646lm, CRI=80 Dimmer</p> <p>Materials: aluminum, methacrylate</p>	<p>1732020A</p>	<p>9.167,34</p>	<p>11.459,18</p>	<p>white diffuser, chromed stem, white base</p>
	<p>STELLAR NEBULA BIG Table lamp</p> <p>IP20 LED 3000K, 9W, 300lm, CRI=90 Dimmer</p> <p>Materials: blown glass with PVD treatment, aluminum</p>	<p>0152320A</p>	<p>19.706,40</p>	<p>24.633,00</p>	<p>transparent diffuser with dichroic PVD treatment</p>
	<p>TAKKU Foster + Partners Table lamp</p> <p>IP 20 LED 3000K, 2,5W, 120lm, CRI=90 USB recharge</p> <p>Materials: aluminum, methacrylate</p>	<p>0151030A 0151050A 0151060A 0151020A 0151040A 0151010A</p>	<p>3.791,55 3.791,55 3.791,55 3.791,55 3.434,13 3.434,13</p>	<p>4.739,44 4.739,44 4.739,44 4.739,44 4.292,66 4.292,66</p>	<p>anodized red anodized blu anodized green anodized grey painted black painted white 3 light intensities</p>
	<p>TALAK PROFESSIONAL TABLE Neil Poulton Table lamp</p> <p>IP 20 LED 3000K, 12W, 1065lm, CRI=90 Dimmer</p> <p>Materials: aluminum, technopolymer, steel</p>	<p>0687510A 0678510A</p>	<p>6.554,31 5.733,21</p>	<p>8.192,89 7.166,51</p>	<p>body white, chromed stem, white base white body, chromed stem, polished aluminium clamp</p>
	<p>TEMPIO Atelier Oi Table lamp</p> <p>IP 20 LED 3000K, 14W, 524lm, CRI=90 Dimmer</p> <p>Materials: aluminum, steel</p>	<p>0052010A</p>	<p>6.964,86</p>	<p>8.706,08</p>	<p>bronze</p>
	<p>TIZIO Richard Sapper Table lamp</p> <p>IP 20 LED 3,3W (GY6,35) </p> <p>Materials: aluminum, technopolymer</p>	<p>A009010 A009030</p>	<p>4.404,96 4.404,96</p>	<p>5.506,20 5.506,20</p>	<p>black white</p>
	<p>TIZIO LED Richard Sapper Table lamp</p> <p>IP 20 LED 3000K, 8W, 468lm, CRI=90 Dimmer</p> <p>Materials: aluminum, technopolymer</p>	<p>A009210</p>	<p>6.254,85</p>	<p>7.818,56</p>	<p>3000K, black</p>

TABLE LAMPS

 <p>TIZIO 35 Richard Sapper Table lamp</p> <p>IP 20 LED 3,3W (GY6,35) </p> <p>Materials: aluminum, technopolymer</p>	<p>A005010</p>	<p>3.844,68</p>	<p>4.805,85</p>	<p>black</p> <p>2 light intensities</p>
 <p>TIZIO MICRO Richard Sapper Table lamp</p> <p>IP 20 LED 2,4W (G4) </p> <p>Materials: aluminum</p>	<p>A008100</p>	<p>3.694,95</p>	<p>4.618,69</p>	<p>black</p>
 <p>TOLOMEO Michele De Lucchi, Giancarlo Fassina Table lamp</p> <p>IP 20 LED 1x10,5W (E27) </p> <p>Materials: aluminum, steel</p>	<p>A001000 A004420 A004430 A004030 A005320 A005330 A004200 A004100</p>	<p>2.415,00 2.415,00 2.415,00 1.381,38 1.429,68 1.429,68 608,58 608,58</p>	<p>3.018,75 3.018,75 3.018,75 1.726,73 1.787,10 1.787,10 760,73 760,73</p>	<p>body lamp aluminium body lamp white body lamp black table base ø cm. 23: aluminium table base ø cm. 23: white table base ø cm. 23: black desk fixed support aluminium table clamp aluminium</p> <p>Complete lamp consists of 2 items.</p>
 <p>TOLOMEO LED Michele De Lucchi, Giancarlo Fassina Table lamp</p> <p>IP 20 LED 2700K, 8W, 737lm, CRI=90 Dimmer</p> <p>LED 3000K, 8W, 761lm, CRI=90 Dimmer</p> <p>LED TW 2200/6500K (amber, white, blue), 11W, 560lm/716lm, CRI=90 Dimmer</p> <p>Materials: aluminum, steel</p>	<p>A0048W00 A004800 A0054W00 A005400 1530050A A004030 A004200 A004100</p>	<p>3.434,13 3.434,13 3.791,55 3.791,55 4.974,90 1.381,38 608,58 608,58</p>	<p>4.292,66 4.292,66 4.739,44 4.739,44 6.218,63 1.726,73 760,73 760,73</p>	<p>2700K: body lamp aluminium 3000K: body lamp aluminium 2700K: with presence detector, body lamp aluminium 3000K: with presence detector, body lamp aluminium LED TW: body lamp aluminium table base ø cm. 23: aluminium desk fixed support aluminium table clamp aluminium</p> <p>Complete lamp consists of 2 items.</p>
 <p>TOLOMEO LED PURE INTEGRALIS Michele De Lucchi, Giancarlo Fassina Table lamp</p> <p>IP20 LED Integralis: 3600K, 7W, 483lm, CRI=80 Dimmer</p> <p>Materials: aluminum, steel</p>	<p>A004800IN2 A004030 A004200 A004100</p>	<p>3.844,68 1.381,38 608,58 608,58</p>	<p>4.805,85 1.726,73 760,73 760,73</p>	<p>body lamp table base ø cm. 23: aluminium desk fixed support aluminium table clamp aluminium</p> <p>Complete lamp consists of 2 items.</p>
 <p>TOLOMEO BASCULANTE TABLE Michele De Lucchi, Giancarlo Fassina Table lamp</p> <p>IP 20 LED 1x7,5W (E27) </p> <p>Materials: parchment paper or silk satin, aluminum, steel</p>	<p>0947010A 0947020A A004030 A004200 A004100</p>	<p>3.284,40 3.284,40 1.381,38 608,58 608,58</p>	<p>4.105,50 4.105,50 1.726,73 760,73 760,73</p>	<p>body lamp with parchment diffuser ø mm. 180 body lamp with silk diffuser ø mm. 180 table base ø cm. 23: aluminium desk fixed support aluminium table clamp aluminium</p> <p>Complete lamp consists of 2 items.</p>

Code	Veil Pris NOK eks mva	Veil Pris NOK ink mva
------	-----------------------------	-----------------------------

TABLE LAMPS



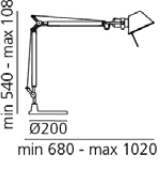
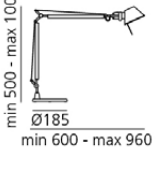
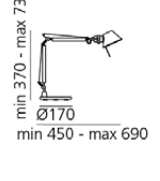


 <p>min 540 - max 1080 Ø200 min 680 - max 1020</p>	TOLOMEO MINI	A005910	2.361,87	2.952,34	body lamp aluminium	
	Michele De Lucchi, Giancarlo Fassina Table lamp	A005920	2.361,87	2.952,34	body lamp white	
	IP 20	A005940	2.361,87	2.952,34	body lamp black	
	LED 1x10,5W (E27) 	A008600	1.333,08	1.666,35	table base ø cm. 20: aluminium	
	Materials: aluminum, steel	A008610	1.381,38	1.726,73	table base ø cm. 20: black	
		A008620	1.381,38	1.726,73	table base ø cm. 20: white	
		A004200	608,58	760,73	desk fixed support aluminium	
		A004100	608,58	760,73	table clamp aluminium	
					Complete lamp consists of 2 items.	
 <p>min 540 - max 1080 Ø200 min 680 - max 1020</p>	TOLOMEO MINI LED	A0056W00	3.434,13	4.292,66	2700K, body lamp aluminium	
	Michele De Lucchi, Giancarlo Fassina Table lamp	A005600	3.434,13	4.292,66	3000K, body lamp aluminium	
	IP 20	A0055W00	3.743,25	4.679,06	2700K, with presence detector, body lamp aluminium	
	LED 2700K, 8W, 737lm, CRI=90 Dimmer	A005500	3.743,25	4.679,06	3000K, with presence detector, body lamp aluminium	
		A008600	1.333,08	1.666,35	table base ø cm. 20: aluminium	
	LED 3000K, 8W, 761lm, CRI=90 Dimmer	A004200	608,58	760,73	desk fixed support aluminium	
	Materials: aluminum, steel	A004100	608,58	760,73	table clamp aluminium	
					Complete lamp consists of 2 items.	
	 <p>min 500 - max 1000 Ø185 min 600 - max 960</p>	TOLOMEO MIDI LED	A0151W00	2.970,45	3.713,06	2700K, body lamp aluminium
Michele De Lucchi, Giancarlo Fassina Table lamp		A015100	3.023,58	3.779,48	3000K, body lamp aluminium	
IP 20		A003900	970,83	1.213,54	base aluminium	
LED 2700K, 7W, 620lm, CRI=90 Dimmer		A004200	608,58	760,73	desk fixed support aluminium	
		A004100	608,58	760,73	table clamp aluminium	
LED 3000K, 7W, 648lm, CRI=90 Dimmer					Complete lamp consists of 2 items.	
 <p>min 370 - max 730 Ø170 min 450 - max 690</p>	TOLOMEO MICRO	A011800	2.970,45	3.713,06	body lamp and base: aluminium	
	Michele De Lucchi, Giancarlo Fassina Table lamp	A011810	3.023,58	3.779,48	body lamp and base: anodized red	
	IP 20	A011830	2.970,45	3.713,06	body lamp and base: black	
	LED 1x5W (E14) 	A011860	3.023,58	3.779,48	body lamp and base: anodized orange	
	Materials: aluminum, steel	A011850	3.023,58	3.779,48	body lamp and base: anodized blue	
		A001300	3.023,58	3.779,48	body lamp and base: polished aluminium	
		0011860A	3.023,58	3.779,48	body lamp and base: gold	
		0011820A	2.922,15	3.652,69	body lamp and base: polished white	
		A010900	2.202,48	2.753,10	body lamp only: aluminium	
		A010910	2.202,48	2.753,10	body lamp only: anodized red	
		A010930	2.202,48	2.753,10	body lamp only: black	
		A010950	2.202,48	2.753,10	body lamp only: anodized blue	
		A010960	2.202,48	2.753,10	body lamp only: anodized orange	
		0010920A	2.149,35	2.686,69	body lamp only: polished white	
		A004200	608,58	760,73	desk fixed support aluminium	
		A004100	608,58	760,73	table clamp aluminium	
	 <p>min 370 - max 730 Ø170 min 450 - max 690</p>	TOLOMEO MICRO LED	A0119W00	3.791,55	4.739,44	2700K, body lamp and base: aluminium
		Michele De Lucchi, Giancarlo Fassina Table lamp	A011900	3.844,68	4.805,85	3000K, body lamp and base: aluminium
		IP 20	A0103W00	3.023,58	3.779,48	2700K, body lamp only: aluminium
		LED 2700K, 7W, 620lm, CRI=90 Dimmer	A010300	3.023,58	3.779,48	3000K, body lamp only: aluminium
		A004200	608,58	760,73	desk fixed support aluminium	
		A004100	608,58	760,73	table clamp aluminium	

TABLE LAMPS

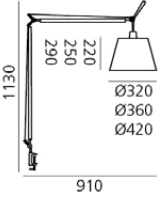


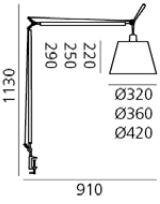

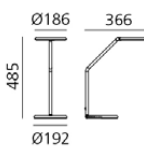
		Code	Veil Pris NOK eks mva	Veil Pris NOK ink mva			
 <p>TOLOMEO MEGA TABLE Michele De Lucchi, Giancarlo Fassina Table lamp with clamp or fixed table</p> <p>IP 20 Ø 320: LED / LED DIM* 1x21W (E27) </p> <p>Ø 360, 420: LED / LED DIM* 1x21W (E27) </p> <p>Materials: textile fabric or silk satin or parchment paper, aluminum, steel</p>		0564010A	3.892,98	4.866,23	body lamp with switch ON-OFF: aluminium		
		0564030A	3.892,98	4.866,23	body lamp with switch ON-OFF: black		
		0778010A	4.351,83	5.439,79	body lamp with dimmer: aluminium *		
		0778030A	4.351,83	5.439,79	body lamp with dimmer: black *		
		0780010A	1.642,20	2.052,75	parchment paper diffuser ø 320 mm		
		0780020A	1.743,63	2.179,54	parchment paper diffuser ø 360 mm		
		0780030A	1.840,23	2.300,29	parchment paper diffuser ø 420 mm		
		0781010A	1.791,93	2.239,91	silk diffuser ø 320 mm		
		0781020A	2.250,78	2.813,48	silk diffuser ø 360 mm		
		0781030A	2.415,00	3.018,75	silk diffuser ø 420 mm		
		0772010A	1.791,93	2.239,91	black satin diffuser ø 320 mm		
		0772020A	2.299,08	2.873,85	black satin diffuser ø 360 mm		
		0772030A	2.559,90	3.199,88	black satin diffuser ø 420 mm		
		A004200	608,58	760,73	desk fixed support aluminium		
		A004100	608,58	760,73	table clamp aluminium		
		Complete lamp consists of 3 items.					
		 <p>TOLOMEO MEGA LED TABLE Michele De Lucchi, Giancarlo Fassina Table lamp with clamp or fixed table</p> <p>IP 20 LED 2700K*, 31W, CRI=90* Dimmer</p> <p>LED 3000K**, 31W, CRI=90** Dimmer</p> <p>Materials: textile fabric or silk satin or parchment paper, aluminum, steel</p>		0762W10A	6.506,01	8.132,51	2700K, body lamp with dimmer on cable: aluminium
				0762010A	6.506,01	8.132,51	3000K, body lamp with dimmer on cable: aluminium
0762W30A	6.506,01			8.132,51	2700K, body lamp with dimmer on cable: black		
0762030A	6.506,01			8.132,51	3000K, body lamp with dimmer on cable: black		
0761W10A	5.684,91			7.106,14	2700K, body lamp with microswitch dimmer: aluminium		
0761010A	5.684,91			7.106,14	3000K, body lamp with microswitch dimmer: aluminium		
0761W30A	5.684,91			7.106,14	2700K, body lamp with microswitch dimmer: black		
0761030A	5.684,91			7.106,14	3000K, body lamp with microswitch dimmer: black		
0780010A	1.642,20			2.052,75	parchment paper diffuser ø 320 mm, 1868lm*/1999lm**		
0780020A	1.743,63			2.179,54	parchment paper diffuser ø 360 mm, 1871lm*/2002lm**		
0780030A	1.840,23			2.300,29	parchment paper diffuser ø 420 mm, 1884lm*/2016lm**		
0781010A	1.791,93			2.239,91	silk diffuser ø 320 mm, 1770lm*/1894lm**		
0781020A	2.250,78			2.813,48	silk diffuser ø 360 mm, 1786lm*/1912lm**		
0781030A	2.415,00			3.018,75	silk diffuser ø 420 mm, 1789lm*/1914lm**		
0772010A	1.791,93			2.239,91	black satin diffuser ø 320 mm, 1579lm*/ 1690lm**		
0772020A	2.299,08			2.873,85	black satin diffuser ø 360 mm, 1571lm*/1681lm**		
0772030A	2.559,90			3.199,88	black satin diffuser ø 420 mm, 1582lm*/1693lm**		
A004200	608,58			760,73	desk fixed support aluminium		
A004100	608,58	760,73	table clamp aluminium				
Complete lamp consists of 3 items.							
 <p>UNTERLINDEN TABLE Herzog & de Meuron Table lamp</p> <p>IP 20 LED 2700K, 9W, 339lm, CRI=90 Dimmer</p> <p>LED 3000K, 9W, 349lm, CRI=90 Dimmer</p> <p>Materials: brass or aluminum</p>		1945W10A	6.143,76	7.679,70	2700K, antique aluminium		
		1945010A	6.143,76	7.679,70	3000K, antique aluminium		
		1946W10A	6.554,31	8.192,89	2700K, antique brass		
		1946010A	6.554,31	8.192,89	3000K, antique brass		
 <p>VINE LIGHT BIG Table lamp</p> <p>IP20 LED 3000K, 8W, 602lm, CRI=90 Dimmer</p> <p>Materials: aluminum, zamac, technopolymer</p>		1564030A	5.274,36	6.592,95	black		


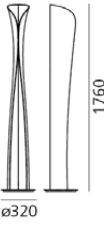


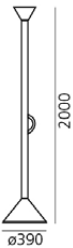



TABLE LAMPS

	<p>VINE LIGHT FIXED BIG Table lamp</p> <p>IP20 LED 3000K, 8W, 602lm, CRI=90 Dimmer</p> <p>Materials: aluminum, zamac, technopolymer</p>	1565030A	5.076,33	6.345,41	black
	<p>VINE LIGHT PURE INTEGRALIS BIG Table lamp</p> <p>IP20 LED Integralis: 3600K, 8W, 675lm, CRI=82 Dimmer</p> <p>Materials: aluminum, zamac, technopolymer</p>	1564030IN2A	5.796,00	7.245,00	black
	<p>YANZI TABLE Neri&Hu Table lamp</p> <p>IP 20 LED 3000K, 9,5W, 623lm, CRI=90 Dimmer</p> <p>Materials: blown glass, aluminum, zamac</p>	1101010A	5.023,20	6.279,00	white diffuser, brushed brass body, black base

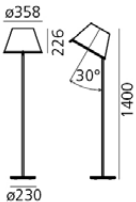

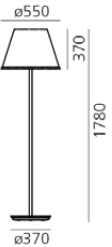


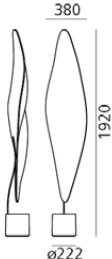


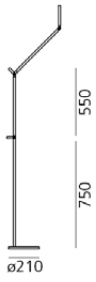
FLOOR LAMPS

	<p>ARRIVAL FLOOR Ludovica+Roberto Palomba Floor lamp</p> <p>IP 20 LED Strip 3000K, 77W, 2422lm, CRI=90 Dimmer</p> <p>Materials: aluminum, silicone, steel</p>	1552010APP	30.071,58	37.589,48	gold, Artemide APP
		1552030APP	30.071,58	37.589,48	black matt, Artemide APP
	<p>ATHENA Naoto Fukasawa Floor lamp</p> <p>IP 20 LED 2700K, 44W, 3266lm, CRI=90 Dimmer</p> <p>LED 3000K, 44W, 3492lm, CRI=90 Dimmer</p> <p>Materials: aluminum, steel</p>	1833W20A	11.427,78	14.284,73	2700K, white
		1833020A	11.427,78	14.284,73	3000K, white
		1833W30A	11.427,78	14.284,73	2700K, black
		1833030A	11.427,78	14.284,73	3000K, black
	<p>ATHENA WHITE INTEGRALIS Naoto Fukasawa Floor lamp</p> <p>IP 20 LED 5000K, 44W, 4106lm, CRI= 90 Dimmer</p> <p>Materials: aluminum, steel</p>	1833030IN0A	11.427,78	14.284,73	black
		1833020IN0A	11.427,78	14.284,73	white

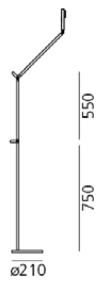

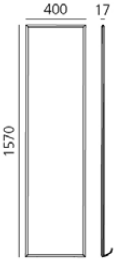
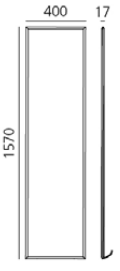
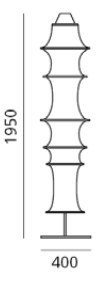


FLOOR LAMPS

		Code	Veil Pris NOK eks mva	Veil Pris NOK ink mva	
	<p>CABILDO LED FLOOR Eric Solé Floor lamp</p> <p>IP 20 LED 2700K, 44W, 2641lm, CRI=90 Dimmer</p> <p>LED 3000K, 44W, 2824lm, CRI=90 Dimmer</p> <p>Materials: aluminum, steel</p>	1180W10A	11.427,78	14.284,73	2700K, white
		1180010A	11.427,78	14.284,73	3000K, white
	<p>CADMO LED Karim Rashid Floor lamp</p> <p>IP 20 indirect: LED 2700K, 44W, 3831lm, CRI=90 + direct: LED 2700K, 10W (GU10)  Dimmer/direct not dimmable</p> <p>indirect: LED 3000K, 44W, 4003lm, CRI=90 + direct: LED 2700K, 10W (GU10)  Dimmer/direct not dimmable</p> <p>Materials: steel</p>	1361W10A	21.628,74	27.035,93	2700K, black/white inside
		1361010A	21.628,74	27.035,93	3000K, black/white inside
		1361W20A	20.136,27	25.170,34	2700K, white
		1361020A	20.136,27	25.170,34	3000K, white
	<p>CALLIMACO LED Ettore Sottsass Floor lamp</p> <p>IP 20 LED 2700K, 43W, 3225lm, CRI=90 Dimmer</p> <p>Materials: steel, aluminum</p>	A0111W00	16.803,57	21.004,46	2700K, multicolour
	<p>CASTORE 35 FLOOR Michele De Lucchi, Hubb Ubbens Floor lamp</p> <p>IP 20 LED DIM 1x21W (E27)  Dimmer</p> <p>Materials: blown glass, polycarbonate, zamac</p>	1055010A	10.051,23	12.564,04	white
	<p>CHIMERA LED Vico Magistretti Floor lamp</p> <p>IP 20 LED 2700K, 41W, 3300lm, CRI=90 Dimmer</p> <p>Materials: methacrylate, aluminium, zamac</p>	0084110APP	28.738,50	35.923,13	white
					NEW


FLOOR LAMPS


		Code	Veil Pris NOK eks mva	Veil Pris NOK ink mva	
 <p>CHOOSE FLOOR Matteo Thun Floor lamp</p> <p>IP 20 LED 2x8W (E27) </p> <p>Materials: polycarbonate, parchment paper, steel, zamac</p>	1136020A	6.143,76	7.679,70	parchment paper diffuser, structure anthracite grey	
	1136110A	7.423,71	9.279,64	diffuser white, structure chrome	
	1136120A	7.423,71	9.279,64	parchment paper diffuser, structure chrome	
 <p>CHOOSE MEGA FLOOR Matteo Thun Floor lamp</p> <p>IP 20 direct: LED 3x15W (E27)  + indirect: LED 1x8W (E27) </p> <p>Materials: polycarbonate, parchment paper, steel, zamac</p>	1135020A	10.857,84	13.572,30	parchment paper diffuser, structure anthracite grey	
	1135110A	13.069,98	16.337,48	diffuser white, structure chrome	
	1135120A	13.069,98	16.337,48	parchment paper diffuser, structure chrome	
 <p>COSMIC LEAF FLOOR Ross Lovegrove Floor lamp</p> <p>IP 20 LED 1x8,5W (G53) </p> <p>Materials: methacrylate, steel</p>	1504010A	12.712,56	15.890,70	transparent diffuser, grey structure	
 <p>DECOMPOSE' LIGHT FLOOR Atelier Oi Floor lamp</p> <p>IP 20 LED 3000K, 45W, 3564lm, CRI=90 Dimmer</p> <p>Materials: aluminum</p>	DOI4600D02	15.320,76	19.150,95	gold	
	DOI4600D03	15.320,76	19.150,95	orange	
	DOI4600D16	15.320,76	19.150,95	red	
	DOI4600D80	15.320,76	19.150,95	smoked	
 <p>DEMETRA READING FLOOR Naoto Fukasawa Floor lamp</p> <p>IP 20 LED 2700K, 8W, 360lm, CRI=90 Dimmer</p> <p>LED 3000K, 8W, 385lm, CRI=90 Dimmer</p> <p>Materials: aluminum, technopolymer, steel</p>	1734W10A	3.844,68	4.805,85	body lamp 2700K anthracite grey	
	1734010A	3.844,68	4.805,85	body lamp 3000K anthracite grey	
	1734W20A	3.844,68	4.805,85	body lamp 2700K white	
	1734020A	3.844,68	4.805,85	body lamp 3000K white	
	1734W50A	3.844,68	4.805,85	body lamp 2700K opaque black	
	1734050A	3.844,68	4.805,85	body lamp 3000K opaque black	
	1735010A	4.255,23	5.319,04	body 3000K w/presence detector, anthracite grey	
	1735020A	4.255,23	5.319,04	body 3000K w/presence detector, white	
	1735050A	4.255,23	5.319,04	body 3000K w/presence detector, opaque black	
	1741010A	2.559,90	3.199,88	floor support anthracite grey	
	1741020A	2.559,90	3.199,88	floor support white	
	1741050A	2.559,90	3.199,88	floor support opaque black	
					Complete lamp consists of 2 items.

FLOOR LAMPS

 <p>DEMETRA PROFESSIONAL READING FLOOR Naoto Fukasawa Floor lamp</p> <p>IP 20 LED 3000K, 12W, 960lm, CRI=90 Dimmer</p> <p>Materials: aluminum, technopolymer, steel</p>	1739010A	5.023,20	6.279,00	body lamp, anthracite grey
	1739020A	5.023,20	6.279,00	body lamp, white
	1739050A	5.023,20	6.279,00	body lamp, opaque black
	1740010A	5.535,18	6.918,98	body w/presence detector, anthracite grey
	1740020A	5.535,18	6.918,98	body w/presence detector, white
	1740050A	5.535,18	6.918,98	body w/presence detector, opaque black
	1741010A	2.559,90	3.199,88	floor support anthracite grey
	1741020A	2.559,90	3.199,88	floor support white
	1741050A	2.559,90	3.199,88	floor support opaque black
				Complete lamp consists of 2 items.
 <p>DISCOVERY FLOOR TW Ernesto Gismondi Floor lamp</p> <p>IP 20 LED 2700/6500K, 61W, 3805lm/4054lm, CRI=80 Dimmer</p> <p>Materials: technopolymer, aluminum</p>	2040030APP	22.189,02	27.736,28	black, Artemide APP
 <p>DISCOVERY FLOOR RGBW Ernesto Gismondi Floor lamp</p> <p>IP 20 LED 56W, RGB 1036lm White 1817lm, CRI=90 Dimmer</p> <p>Materials: technopolymer, aluminum</p>	2041030APP	22.749,30	28.436,63	black, Artemide APP
 <p>DISCOVERY FLOOR WHITE VIOLET INTEGRALIS Ernesto Gismondi Floor lamp</p> <p>IP 20 LED Day mode 2700K, 67W, 2972lm, CRI= 80 LED Night mode 67W Dimmer</p> <p>Materials: technopolymer, aluminum</p>	2040030IN1APP	22.749,30	28.436,63	black, Artemide APP
 <p>FALKLAND FLOOR Bruno Munari Floor lamp</p> <p>IP 20 LED 1x8W (E27) </p> <p>Materials: elastic fabric, steel</p>	 DS2040BAR00	2.922,15	3.652,69	aluminium grey structure
	DS2040BB00	1.364,48	1.705,59	aluminium grey base lamp
	DS2040CRC	1.569,75	1.962,19	fabric 165 + inox hoops
	DS2040CRCI	1.618,05	2.022,56	fireproof fabric 165 + inox hoops

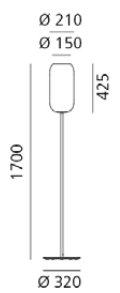





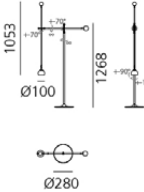
LED Not replaceable integrated LED source

 Included source

 Excluded source

Code	Veil Pris NOK eks mva	Veil Pris NOK ink mva
------	-----------------------------	-----------------------------


FLOOR LAMPS


 <p>GOPLE FLOOR BIG Floor lamp</p> <p>IP 20 LED DIM 1x20W (E27)  Dimmer</p> <p>Materials: aluminium, white blown glass with nuances or blown glass with PVD treatment</p>	1410010A	12.171,60	15.214,50	silver structure and diffuser PVD
	1410020A	10.857,84	13.572,30	silver structure and nuanced white diffuser
	1410040A	12.171,60	15.214,50	silver structure and copper diffuser PVD
	1410050A	12.171,60	15.214,50	silver structure and blue sapphire diffuser PVD
	1410060A	12.171,60	15.214,50	silver structure and bronze diffuser PVD
	1410220A	10.558,38	13.197,98	white structure and nuanced white diffuser
	1410340A	11.857,65	14.822,06	black structure and copper diffuser PVD
	1410350A	11.857,65	14.822,06	black structure and blue sapphire diffuser PVD
	1410360A	11.857,65	14.822,06	black structure and bronze diffuser PVD
 <p>ILIO 10th YEAR Ernesto Gismondi Floor lamp</p> <p>IP 20 LED 2700K, 45W, 3332lm, CRI=90 Dimmer</p> <p>Materials: aluminum with PVD treatment, steel</p>	1640W00APP	14.526,23	18.157,78	2700K, limited edition of 2000 pieces, signed and numbered, Artemide APP
 <p>ILIO Ernesto Gismondi Floor lamp</p> <p>IP 20 LED 2700K, 45W, 3332lm, CRI=90 Dimmer</p> <p>LED 3000K, 45W, 3564lm, CRI=90 Dimmer</p> <p>Materials: aluminum, steel</p>	1640W10APP	10.345,86	12.932,33	2700K, rubin red, Artemide APP
	1640010APP	10.345,86	12.932,33	3000K, rubin red, Artemide APP
	1640W20APP	10.345,86	12.932,33	2700K, glossy white, Artemide APP
	1640020APP	10.345,86	12.932,33	3000K, glossy white, Artemide APP
	1640W30APP	10.345,86	12.932,33	2700K, glossy black, Artemide APP
	1640030APP	10.345,86	12.932,33	3000K, glossy black, Artemide APP
	1640W80APP	10.345,86	12.932,33	2700K, black opaque, Artemide APP
	1640080APP	10.345,86	12.932,33	3000K, black opaque, Artemide APP
 <p>ILIO WHITE INTEGRALIS Ernesto Gismondi Floor lamp</p> <p>IP 20 LED 5000K, 45W, 3920lm, CRI=90 Dimmer</p> <p>Materials: aluminum, steel</p>	1640010INOAPP	10.345,86	12.932,33	rubin red, Artemide APP
	1640020INOAPP	10.345,86	12.932,33	glossy white, Artemide APP
	1640030INOAPP	10.345,86	12.932,33	glossy black, Artemide APP
	1640080INOAPP	10.345,86	12.932,33	matt black, Artemide APP
 <p>ILIO MINI Ernesto Gismondi Floor lamp</p> <p>IP 20 LED 3000K, 23W, 1528lm, CRI=90 Dimmer</p> <p>LED 2700K, 23W, 1462lm, CRI=90 Dimmer</p> <p>Materials: aluminum, steel</p>	1645080APP	7.834,26	9.792,83	3000K, matt black, Artemide APP
	1645090APP	7.834,26	9.792,83	3000K, matt white, Artemide APP
	1645W80APP	7.834,26	9.792,83	2700K, matt black, Artemide APP
	1645W90APP	7.834,26	9.792,83	2700K, matt white, Artemide APP
 <p>IXA FLOOR Foster + Partners Floor lamp</p> <p>IP20 LED 3000K, 9W, 465lm, CRI=90 Dimmer</p> <p>Materials: aluminum, steel, technopolymer</p>	1111010A	12.075,00	15.093,75	anthracite
	1111020A	12.075,00	15.093,75	white/grey
	1111030A	12.075,00	15.093,75	blue
	1111040A	12.075,00	15.093,75	yellow
	1111050A	12.075,00	15.093,75	red

NEW

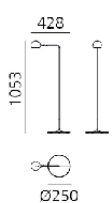
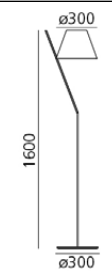


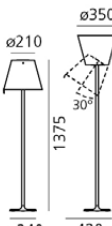

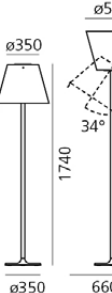

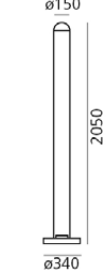
NEW

LED Not replaceable integrated LED source

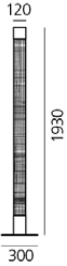
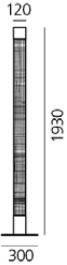






 Included source


 Excluded source


FLOOR LAMPS


		Code	Veil Pris NOK eks mva	Veil Pris NOK ink mva	
 <p>IXA READING FLOOR Foster + Partners Floor lamp</p> <p>IP20 LED 3000K, 9W, 465lm, CRI=90 Dimmer</p> <p>Materials: aluminum, steel, technopolymer</p>		1112010A	6.356,28	7.945,35	anthracite
		1112020A	6.356,28	7.945,35	white/grey
		1112030A	6.356,28	7.945,35	blue
		1112040A	6.356,28	7.945,35	yellow
		1112050A	6.356,28	7.945,35	red
 <p>LA PETITE FLOOR Andrea Quaglio, Manuela Simonelli Floor lamp</p> <p>IP 20 LED 1x12W (E27) </p> <p>Materials: polycarbonate, aluminum, methacrylate</p>		1753020A	7.887,39	9.859,24	white
		1753030A	7.887,39	9.859,24	black
 <p>MEGARON LED Gianfranco Frattini Floor lamp</p> <p>IP 20 LED 2700K, 45W, 3480lm, CRI=90 Dimmer</p> <p>LED 3000K, 45W, 3697lm, CRI=90 Dimmer</p> <p>Materials: aluminum, steel, technopolymer</p>		A0160W00	13.944,21	17.430,26	2700K, polished anodised aluminium
		A016000	13.944,21	17.430,26	3000K, polished anodised aluminium
		A0160W50	13.219,71	16.524,64	2700K, black
		A016050	13.219,71	16.524,64	3000K, black
 <p>MELAMPO FLOOR Adrien Gardère Floor lamp</p> <p>IP 20 LED 2x17W (E27) </p> <p>Materials: technopolymer, silk satin, aluminum, zamac</p>		0123010A	6.143,76	7.679,70	structure and diffuser grey
		0123020A	6.143,76	7.679,70	structure bronze, diffuser neutral
 <p>MELAMPO MEGA FLOOR Adrien Gardère Floor lamp</p> <p>IP 20 LED DIM 2x21W (E27) </p> <p>Dimmer</p> <p>Materials: technopolymer, silk satin, aluminum, zamac</p>		0577010A	12.809,16	16.011,45	structure and diffuser grey
		0577020A	12.809,16	16.011,45	structure bronze, diffuser neutral
 <p>METACOLOR LED Ernesto Gismondi Floor lamp</p> <p>IP 20 LED 3000K, 40W, 2500lm, CRI=90 + LED 86W RGB Dimmer</p> <p>Materials: methacrylate, steel</p>		0473110APP	33.404,28	41.755,35	white / Artemide APP

FLOOR LAMPS

 <p>MIMESI Carlotta de Bevilacqua Floor lamp</p> <p>IP 20 indirect: LED 3000K, 42W, 3733lm, CRI=90 + diffused: LED 6000K, 3W, 100lm, CRI=80 Dimmer</p> <p>Materials: technopolymer , aluminum, steel</p>	1835010APP	22.338,75	27.923,44	transparent structure, Artemide APP
 <p>MIMESI WHITE INTEGRALIS Carlotta de Bevilacqua Floor lamp</p> <p>IP 20 LED 5000K, 42W, 3887lm, CRI=90 Dimmer</p> <p>Materials: technopolymer , aluminum, steel</p>	1835010IN0APP	22.338,75	27.923,44	transparent structure, Artemide APP
 <p>MINOMUSHI FLOOR Issey Miyake + Reality Lab Floor lamp</p> <p>IP 20 LED 3000K, 28W, 2527lm, CRI=90 Dimmer</p> <p>Materials: PET, methacrylate, steel, polycarbonate</p>	1698010A	23.208,15	29.010,19	white
 <p>MONTJUIC Santiago Calatrava Floor lamp</p> <p>IP 20 LED DIM 1x11W (R7s)  Dimmer</p> <p>Materials: methacrylate, technopolymer</p>	A014400	26.951,40	33.689,25	diffuser white, black structure
 <p>NEW NATURE Ross Lovegrove Floor lamp</p> <p>IP 20 indirect: LED 2700K, 43W, 3132lm, CRI=90+ direct: LED 3000K, 10W, 260lm, CRI=80 Dimmer</p> <p>Materials: technopolymer, aluminum, steel</p>	1157W10APP	33.669,93	42.087,41	2700K, glossy white, Artemide APP
 <p>nh 22 FLOOR Neri&Hu Floor lamp</p> <p>IP 20 LED DIM 1x15W (E27)  Dimmer</p> <p>Materials: blown glass, brass, steel</p>	1271010A	10.099,53	12.624,41	white diffuser, brass body, black structure

 Not replaceable integrated LED source

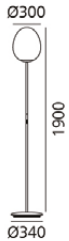
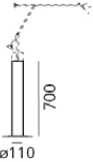

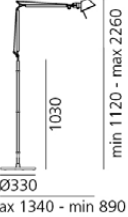
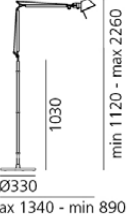

 Included source

 Excluded source

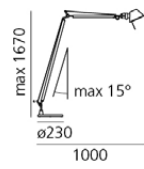


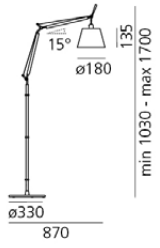






FLOOR LAMPS

	<p>"O" IN Elemental Floor lamp</p> <p>IP 44 LED 3000K, 43W, 1830lm, CRI=90</p> <p>Materials: aluminum, silicone</p>	<p>T073030 T073030APP</p>	<p>15.033,38 17.991,75</p>	<p>18.791,72 22.489,69</p>	<p>black black, Artemide APP</p>
	<p>"O" 150 IN Elemental Floor lamp</p> <p>IP 44 LED 3000K 60W, 3126lm, CRI=90</p> <p>Materials: aluminum, silicone</p>	<p>T073130APP</p>	<p>36.949,50</p>	<p>46.186,88</p>	<p>black, Artemide APP</p>
	<p>PIPE LED FLOOR Herzog & de Meuron Floor lamp</p> <p>IP 20 LED 2700K, 27W, 1763lm, CRI=90 Dimmer</p> <p>Materials: polycarbonate, steel, silicone</p>	<p>0670W10A</p>	<p>19.165,44</p>	<p>23.956,80</p>	<p>translucent white body lamp, black base</p>
	<p>PIPE LED FLOOR WHITE INTEGRALIS Herzog & de Meuron Floor lamp</p> <p>IP 20 LED 5000K, 27W, 2143lm, CRI=90 Dimmer</p> <p>Materials: polycarbonate, steel, silicone</p>	<p>0670010IN0A</p>	<p>19.165,44</p>	<p>23.956,80</p>	<p>translucent white body lamp, black base</p>
	<p>SE ES FLOOR Carolina Gismondi dB, Daniele Moioli Floor lamp</p> <p>IP 67 LED 3000K, 33W, 1200lm, CRI=90 Dimmable (Push & APP)</p> <p>Materials: steel, aluminum, optical silicone</p>	<p>T070410</p>	<p>17.919,30</p>	<p>22.399,13</p>	<p>mirrored</p> <p style="text-align: right;">NEW</p>
	<p>SE ES FLOOR 180 Carolina Gismondi dB, Daniele Moioli Floor lamp</p> <p>IP 67 LED 3000K, 33W, 1200lm, CRI=90 Dimmable (Push & APP)</p> <p>Materials: steel, aluminum, optical silicone</p>	<p>T070510</p>	<p>19.899,60</p>	<p>24.874,50</p>	<p>mirrored</p> <p style="text-align: right;">NEW</p>

FLOOR LAMPS

	<p>STELLAR NEBULA FLOOR BIG Floor lamp</p> <p>IP20 LED 3000K, 20W, 1890lm, CRI=90 Dimmer</p> <p>Materials: blown glass with PVD treatment, aluminium, steel</p>	<p>0152220A</p>	<p>21.005,67</p>	<p>26.257,09</p>	<p>transparent diffuser with dichroic PVD treatment</p>
	<p>TIZIO, TIZIO LED FLOOR SUPPORT Richard Sapper Floor support for Tizio</p> <p>Materials: aluminum, steel</p>	<p>A087700</p>	<p>2.415,00</p>	<p>3.018,75</p>	<p>black</p>
	<p>TIZIO 35 FLOOR SUPPORT Richard Sapper Floor support for Tizio 35</p> <p>Materials: aluminum, steel</p>	<p>A088000</p>	<p>2.361,87</p>	<p>2.952,34</p>	<p>black</p>
	<p>TOLOMEO FLOOR Michele De Lucchi, Giancarlo Fassina Floor lamp</p> <p>IP 20 LED 1x10,5W (E27) ⚡</p> <p>Materials: aluminum, steel</p>	<p>A001000 A004420 A004430 A012820 A014000</p>	<p>2.415,00 2.415,00 2.415,00 3.844,68 671,37</p>	<p>3.018,75 3.018,75 3.018,75 4.805,85 839,21</p>	<p>body lamp aluminium body lamp white body lamp black floor support aluminium-mandatory to compose the lamp aluminium sliding support - accessory</p> <p>Complete lamp consists of 2 items.</p>
	<p>TOLOMEO LED FLOOR Michele De Lucchi, Giancarlo Fassina Floor lamp</p> <p>IP 20 LED 2700K, 8W, 737lm, CRI=90 Dimmer</p> <p>LED 3000K, 8W, 761lm, CRI=90 Dimmer</p> <p>LED TW 2200/6500K (amber, white, blue), 11W, 560lm/716lm, CRI=90 Dimmer</p> <p>LED Integralis: LED 3600K, 7W, 483lm, CRI=80 Dimmer</p> <p>Materials: aluminum, steel</p>	<p>A0048W00 A004800 1530050A A004800IN2 A012820 A014000</p>	<p>3.434,13 3.434,13 4.974,90 3.844,68 3.844,68 671,37</p>	<p>4.292,66 4.292,66 6.218,63 4.805,85 4.805,85 839,21</p>	<p>2700K: body lamp aluminium 3000K: body lamp aluminium LED TW: body lamp aluminium Integralis: body lamp floor support aluminium-mandatory to compose the lamp aluminium sliding support - accessory</p> <p>Complete lamp consists of 2 items.</p>
	<p>TOLOMEO READING FLOOR Michele De Lucchi, Giancarlo Fassina Floor lamp</p> <p>IP 20 LED 1x10,5W (E27) ⚡</p> <p>Materials: aluminum, steel</p>	<p>A013900 A013930 A014900 A014930</p>	<p>3.071,88 3.023,58 1.791,93 1.840,23</p>	<p>3.839,85 3.779,48 2.239,91 2.300,29</p>	<p>body lamp aluminium body lamp black base aluminium base black</p> <p>Complete lamp consists of 2 items.</p>

FLOOR LAMPS

		Code	Veil Pris NOK eks mva	Veil Pris NOK ink mva	
 <p>TOLOMEO READING LED FLOOR Michele De Lucchi, Giancarlo Fassina Floor lamp</p> <p>IP 20 LED 2700K, 8W, 737lm, CRI=90 Dimmer</p> <p>LED 3000K, 8W, 761lm, CRI=90 Dimmer</p> <p>Materials: aluminum, steel</p>	A0131W00	3.892,98	4.866,23	2700K, body lamp aluminium	
	A013100	3.892,98	4.866,23	3000K, body lamp aluminium	
	A014900	1.791,93	2.239,91	base aluminium	
					Complete lamp consists of 2 items.
 <p>TOLOMEO MAXI Michele De Lucchi, Giancarlo Fassina Floor lamp</p> <p>IP 20 LED DIM 1x21W (E27)  Dimmer</p> <p>Materials: parchment paper, aluminum, steel</p>	0510010A	24.188,64	30.235,80	aluminium body, parchment paper diffuser included	
	 <p>TOLOMEO BASCULANTE FLOOR Michele De Lucchi, Giancarlo Fassina Floor lamp</p> <p>IP 20 LED 1x8W (E27) </p> <p>Materials: parchment paper or silk satin, aluminum, steel</p>	0947010A	3.284,40	4.105,50	body lamp with parchment diffuser ø mm. 180
0947020A		3.284,40	4.105,50	body lamp with silk diffuser ø mm. 180	
A012820		3.844,68	4.805,85	floor support aluminium-mandatory to compose the lamp	
A014000		671,37	839,21	aluminium sliding support - accessory	
				Complete lamp consists of 2 items.	
 <p>TOLOMEO BASCULANTE READING FLOOR Michele De Lucchi, Giancarlo Fassina Floor lamp</p> <p>IP 20 LED 1x8W (E27) </p> <p>Materials: parchment paper or silk satin, aluminum, steel</p>	A014600	3.844,68	4.805,85	body lamp with parchment diffuser ø mm. 180	
	A014610	3.844,68	4.805,85	body lamp with silk diffuser ø mm. 180	
	A014900	1.791,93	2.239,91	base aluminium	
				Complete lamp consists of 2 items.	
 <p>TOLOMEO MEGA FLOOR Michele De Lucchi, Giancarlo Fassina Floor lamp</p> <p>IP 20 Ø 320: LED / LED DIM* 1x21W (E27) </p> <p>Ø 360, 420: LED / LED DIM* 1x21W (E27) </p> <p>Materials: textile fabric or silk satin or parchment paper, aluminum, steel</p>	0564010A	3.892,98	4.866,23	body lamp with switch ON-OFF: aluminium	
	0564030A	3.892,98	4.866,23	body lamp with switch ON-OFF: black	
	0778010A	4.351,83	5.439,79	body lamp with dimmer: aluminium *	
	0778030A	4.351,83	5.439,79	body lamp with dimmer: black *	
	0780010A	1.642,20	2.052,75	parchment paper diffuser ø 320 mm	
	0780020A	1.743,63	2.179,54	parchment paper diffuser ø 360 mm	
	0780030A	1.840,23	2.300,29	parchment paper diffuser ø 420 mm	
	0781010A	1.791,93	2.239,91	silk diffuser ø 320 mm	
	0781020A	2.250,78	2.813,48	silk diffuser ø 360 mm	
	0781030A	2.415,00	3.018,75	silk diffuser ø 420 mm	
	0772010A	1.791,93	2.239,91	black satin diffuser ø 320 mm	
	0772020A	2.299,08	2.873,85	black satin diffuser ø 360 mm	
	0772030A	2.559,90	3.199,88	black satin diffuser ø 420 mm	
	0779010A	4.714,08	5.892,60	base + stem aluminium	
0779030A	4.714,08	5.892,60	base + stem black		
				Complete lamp consists of 3 items.	

FLOOR LAMPS



TOLOMEO MEGA LED FLOOR

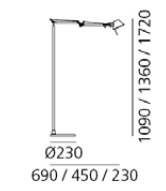
Michele De Lucchi, Giancarlo Fassina
Floor lamp

IP 20
LED 2700K*, 31W, CRI=90
Dimmer

LED 3000K**, 31W, CRI=90
Dimmer

Materials: textile fabric or silk satin or
parchment paper, aluminum, steel

0762W10A	6.506,01	8.132,51	2700K, body lamp with dimmer on cable: aluminium
0762O10A	6.506,01	8.132,51	3000K, body lamp with dimmer on cable: aluminium
0762W30A	6.506,01	8.132,51	2700K, body lamp with dimmer on cable: black
0762O30A	6.506,01	8.132,51	3000K, body lamp with dimmer on cable: black
0761W10A	5.684,91	7.106,14	2700K, body lamp with microswitch dimmer: aluminium
0761O10A	5.684,91	7.106,14	3000K, body lamp with microswitch dimmer: aluminium
0761W30A	5.684,91	7.106,14	2700K, body lamp with microswitch dimmer: black
0761O30A	5.684,91	7.106,14	3000K, body lamp with microswitch dimmer: black
0780010A	1.642,20	2.052,75	parchment paper diffuser ø 320 mm, 1868lm*/1999lm**
0780020A	1.743,63	2.179,54	parchment paper diffuser ø 360 mm, 1871lm*/2002lm**
0780030A	1.840,23	2.300,29	parchment paper diffuser ø 420 mm, 1884lm*/2016lm**
0781010A	1.791,93	2.239,91	silk diffuser ø 320 mm, 1770lm*/1894lm**
0781020A	2.250,78	2.813,48	silk diffuser ø 360 mm, 1786lm*/1912lm**
0781030A	2.415,00	3.018,75	silk diffuser ø 420 mm, 1789lm*/1914lm**
0772010A	1.791,93	2.239,91	black satin diffuser ø 320 mm, 1579lm*/ 1690lm**
0772020A	2.299,08	2.873,85	black satin diffuser ø 360 mm, 1571lm*/1681lm**
0772030A	2.559,90	3.199,88	black satin diffuser ø 420 mm, 1582lm*/1693lm**
0763010A	5.076,33	6.345,41	base+aluminium stem (different code vs halo version)
0763030A	5.076,33	6.345,41	base+black stem (different code vs halo version)
			Complete lamp consists of 3 items.



TOLOMEO MICRO FLOOR

Michele De Lucchi, Giancarlo Fassina
Floor lamp

IP 20
LED 1x4W (E14)

Materials: aluminum, steel

A010900	2.202,48	2.753,10	body lamp only: aluminium
A043900	2.559,90	3.199,88	floor support aluminium
A014000	671,37	839,21	aluminium sliding support - accessory
			Complete lamp consists of 2 items.



TOLOMEO MICRO LED FLOOR

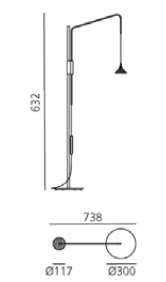
Michele De Lucchi, Giancarlo Fassina
Floor lamp

IP 20
LED 2700K, 7W, 620lm, CRI=90
Dimmer

LED 3000K, 9W, 461lm, CRI=90
Dimmer

Materials: aluminum, steel

A0103W00	3.023,58	3.779,48	2700K, body lamp only: aluminium
A010300	3.023,58	3.779,48	3000K, body lamp only: aluminium
A043900	2.559,90	3.199,88	floor support aluminium
A014000	671,37	839,21	aluminium sliding support - accessory
			Complete lamp consists of 2 items.



UNTELINDEN FLOOR

Herzog & de Meuron
Floor lamp

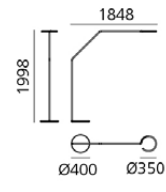
IP20
LED 2700K, 8W, 398lm, CRI=90

LED 3000K, 8W, 416lm, CRI=90

Materials: aluminum or brass, steel,
technopolymer

1095W10A	11.761,05	14.701,31	2700K, antique aluminum
1095O10A	11.761,05	14.701,31	3000K, antique aluminum
1096W10A	12.388,95	15.486,19	2700K, antique brass
1096O10A	12.388,95	15.486,19	3000K, antique brass

NEW



VINE LIGHT FLOOR



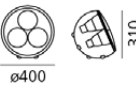
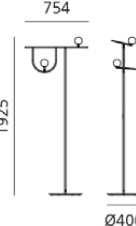
BIG
Floor lamp

IP20
LED 3000K, 35W, 2639lm, CRI=90
Dimmer

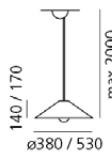

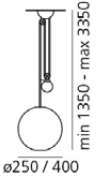

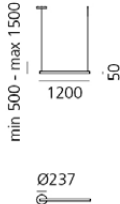
Materials: aluminum, steel, technopolymer

1568030APP	26.391,12	32.988,90	black
------------	-----------	-----------	-------

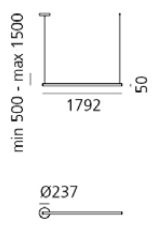
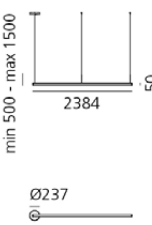
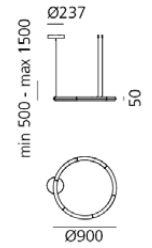
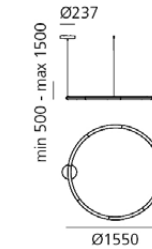
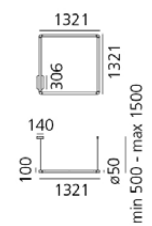
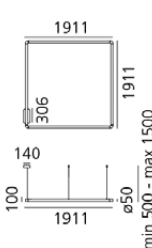
FLOOR LAMPS

 <p>ø400 1769 ø350</p>	<p>VITRUVIO FLOOR Atelier Oi Floor lamp</p> <p>IP 20 LED DIM 1x21W (E27)  Dimmer</p> <p>Materials: aluminum, blown glass, steel</p>	1262010A	17.325,21	21.656,51	brass structure, transparent glass diffuser
			1262030A	17.325,21	21.656,51
 <p>ø400 310</p>	<p>YANG LED Carlotta de Bevilacqua Floor/table lamp</p> <p>IP 20 LED 42W (RGB) Dimmer</p> <p>Materials: polycarbonate, aluminum</p>	0324010APP	31.926,30	39.907,88	Artemide APP
 <p>754 1925 ø400</p>	<p>YANZI FLOOR Neri&Hu Floor lamp</p> <p>IP 20 LED 3000K, 20W, 1414lm, CRI=90 Dimmer</p> <p>Materiali: steel, zamac, blown glass</p>	1102010A	16.702,14	20.877,68	white diffusers, brushed brass bodies, black structure

SUSPENSION LAMPS

 <p>140 / 170 max 2000 ø380 / 530</p>	<p>AGGREGATO SUSPENSION Enzo Mari, Giancarlo Fassina Suspension lamp</p> <p>IP 20 LED DIM 1x15W (E27)  Dimmable</p> <p>Materials: technopolymer, methacrylate or steel</p>	A033200	1.791,93	2.239,91	structure
		A086000	821,10	1.026,38	kit for decentralized suspension
		A089700	1.477,98	1.847,48	cone Ø380 opaline white
		A089860	1.888,53	2.360,66	cone Ø380 metal anthracite grey
		A089400	1.888,53	2.360,66	cone Ø530 opaline white
		A089960	2.415,00	3.018,75	cone Ø530 metal anthracite grey
		A089410	1.540,77	1.925,96	sphere Ø250 opaline white
		A089412	2.709,63	3.387,04	sphere Ø400 opaline white
 <p>min 1350 - max 3350 ø250 / 400</p>	<p>AGGREGATO SALISCENDI Enzo Mari, Giancarlo Fassina Suspension lamp</p> <p>IP 20 LED DIM 1x15W (E27)  Dimmable</p> <p>Materials: technopolymer, methacrylate or steel</p>	A033100	2.511,60	3.139,50	structure
		A086000	821,10	1.026,38	kit for decentralized suspension
		A089700	1.477,98	1.847,48	cone Ø380 opaline white
		A089860	1.888,53	2.360,66	cone Ø380 metal anthracite grey
		A089400	1.888,53	2.360,66	cone Ø530 opaline white
		A089960	2.415,00	3.018,75	cone Ø530 metal anthracite grey
		A089410	1.540,77	1.925,96	sphere Ø250 opaline white
		A089412	2.709,63	3.387,04	sphere Ø400 opaline white
 <p>min 500 - max 1500 1200 50 ø237</p>	<p>ALPHABET OF LIGHT LINEAR 120 BIG Suspension lamp</p> <p>IP 20 LED 3000K, 35W, 3484lm, CRI=80 Dimmable (Push/DALI)</p> <p>LED 3000K, 35W, 3484lm, CRI=80 Dimmable (Push & APP)</p> <p>Materials: methacrylate, aluminum</p>	1204000A	9.988,44	12.485,55	white / Push/DALI
		1204000APP	9.988,44	12.485,55	white / Push & Artemide APP

SUSPENSION LAMPS

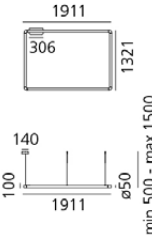
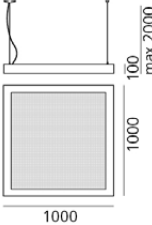
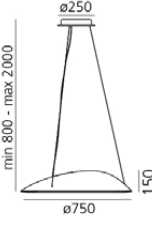
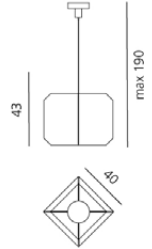



	<p>ALPHABET OF LIGHT LINEAR 180</p> <p>BIG Suspension lamp</p> <p>IP 20 LED 3000K, 50W, 5226lm, CRI=80 Dimmable (Push/DALI)</p> <p>LED 3000K, 50W, 5226lm, CRI=80 Dimmable (Push & APP)</p> <p>Materials: methacrylate, aluminum</p>	1205000A	11.790,03	14.737,54	white / Push/DALI
	<p>1205000APP</p> <p>11.790,03</p> <p>14.737,54</p> <p>white / Push & Artemide APP</p>				
	<p>ALPHABET OF LIGHT LINEAR 240</p> <p>BIG Suspension lamp</p> <p>IP 20 LED 3000K, 63W, 6968lm, CRI=80 Dimmable (Push/DALI)</p> <p>LED 3000K, 63W, 6968lm, CRI=80 Dimmable (Push & APP)</p> <p>Materials: methacrylate, aluminum</p>	1208000A	13.630,26	17.037,83	white / Push/DALI
	<p>1208000APP</p> <p>13.630,26</p> <p>17.037,83</p> <p>white / Push & Artemide APP</p>				
	<p>ALPHABET OF LIGHT CIRCULAR Ø90</p> <p>BIG Suspension lamp</p> <p>IP 20 LED 3000K, 55W, 6041lm, CRI=80 Dimmable (Push/DALI)</p> <p>LED 3000K, 55W, 6041lm, CRI=80 Dimmable (Push & APP)</p> <p>Materials: methacrylate, aluminum</p>	1206000A	18.247,74	22.809,68	white / Push/DALI
	<p>1206000APP</p> <p>18.247,74</p> <p>22.809,68</p> <p>white / Push & Artemide APP</p>				
	<p>ALPHABET OF LIGHT CIRCULAR Ø155</p> <p>BIG Suspension lamp</p> <p>IP 20 LED 3000K, 91W, 10739lm, CRI=80 Dimmable (Push/DALI)</p> <p>LED 3000K, 91W, 10739lm, CRI=80 Dimmable (Push & APP)</p> <p>Materials: methacrylate, aluminum</p>	207000A	28.545,30	35.681,63	white / Push/DALI
	<p>1207000APP</p> <p>28.545,30</p> <p>35.681,63</p> <p>white / Push & Artemide APP</p>				
	<p>ALPHABET OF LIGHT SQUARE 120</p> <p>BIG Suspension lamp</p> <p>IP 20 LED 3000K, 100W, 8195lm, CRI=80 Dimmable(Push/DALI)</p> <p>LED 3000K, 100W, 8195lm, CRI=80 Dimmable (APP)</p> <p>Materials: methacrylate, aluminium</p>	1430010A	34.785,66	43.482,08	white, Push/DALI
	<p>1430010APP</p> <p>34.785,66</p> <p>43.482,08</p> <p>white, Artemide APP</p>				
	<p>ALPHABET OF LIGHT SQUARE 180</p> <p>BIG Suspension lamp</p> <p>IP 20 LED 3000K, 145W, 12104lm, CRI=80 Dimmable(Push/DALI)</p> <p>LED 3000K, 145W, 12104lm, CRI=80 Dimmable (APP)</p> <p>Materials: methacrylate, aluminium</p>	1430020A	43.093,26	53.866,58	white, Push/DALI
	<p>1430020APP</p> <p>43.093,26</p> <p>53.866,58</p> <p>white, Artemide APP</p>				

LED Not replaceable integrated LED source

⦿ Included source


⊗ Excluded source


SUSPENSION LAMPS

	<p>ALPHABET OF LIGHT RECTANGULAR BIG Suspension lamp</p> <p>IP 20 LED 3000K, 120W, 10150lm, CRI=80 Dimmable(Push/DALI)</p> <p>LED 3000K, 125W, 10150lm, CRI=80 Dimmable (APP)</p> <p>Materials: methacrylate, aluminium</p>	1430030A	39.562,53	49.453,16	white, Push/DALI
	<p>1430030APP</p>	39.562,53	49.453,16	white, Artemide APP	
	<p>ALTROVE LED SUSPENSION DIRECT/INDIRECT LIGHT Carlotta de Bevilacqua Suspension lamp</p> <p>IP 20 LED 3000K, 82W, 4699lm, CRI=90 + LED 56W, 735lm (RGB) Dimmable (Push & APP)</p> <p>Materials: methacrylate, aluminium</p>	1340150APP	40.895,61	51.119,51	Artemide APP
	<td>1401010APP</td> <td>28.641,90</td> <td>35.802,38</td> <td>transparent, Push & Artemide APP</td>	1401010APP	28.641,90	35.802,38	transparent, Push & Artemide APP
	<p>AMELUNA Mercedes-Benz Style Suspension lamp</p> <p>IP 20 LED 3000K, 41W, 4231lm, CRI=90 Dimmable (Push & APP)</p> <p>Materials: methacrylate</p>	1402010APP	35.920,71	44.900,89	transparent, RGB / Push & Artemide APP
	<p>AMELUNA RGB Mercedes-Benz Style Suspension lamp</p> <p>IP 20 diffused: LED 3000K, 41W, 4231lm + direct spot: LED 4W RGB Dimmable (Push & APP)</p> <p>Materials: methacrylate</p>	1402010APP	35.920,71	44.900,89	transparent, RGB / Push & Artemide APP
	<p>BALI SUSPENSION Bruno Munari Suspension lamp</p> <p>IP 20 LED DIM 1x8W (E27) </p> <p>Materials: bamboo fiber with elastene, steel, aluminum</p>	<p> DM2003D00</p> <p>DM2003D0N</p>	2.221,80	2.777,25	brass
	<td>2.221,80</td> <td>2.777,25</td> <td>silver</td>	2.221,80	2.777,25	silver	
	<p>CABILDO LED SUSPENSION Eric Solé Suspension lamp</p> <p>IP 20 LED 2700K, 44W, 2641lm, CRI=90 Dimmable (Push)</p> <p>LED 3000K, 44W, 2824lm, CRI=90 Dimmable (Push)</p> <p>Materials: aluminum</p>	1182W10A	6.307,98	7.884,98	2700K, white
	<td>1182010A</td> <td>6.307,98</td> <td>7.884,98</td> <td>3000K, white</td>	1182010A	6.307,98	7.884,98	3000K, white

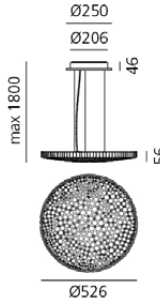
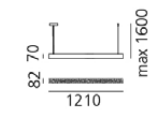
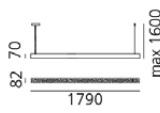
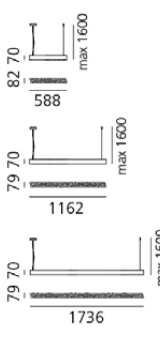
NEW

LED Not replaceable integrated LED source









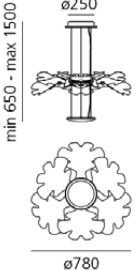
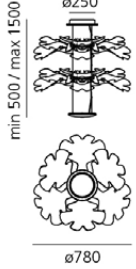
 Included source

 Excluded source

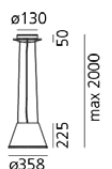

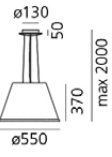

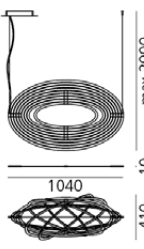
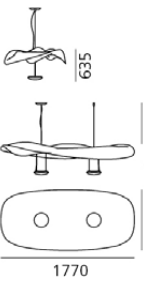

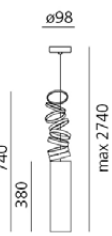

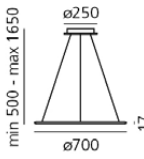
SUSPENSION LAMPS

 <p>CALIPSO SUSPENSION Neil Poulton Suspension lamp</p> <p>IP 20 LED 2700K, 50W, 4038lm, CRI=90 Dimmable (Push)</p> <p>LED 2700K, 50W, 4038lm, CRI=90 Dimmable (Push & APP)</p> <p>LED 3000K, 50W, 4099lm, CRI=90 Dimmable (Push)</p> <p>LED 3000K, 50W, 4099lm, CRI=90 Dimmable (Push & APP)</p> <p>Materials: technopolymer</p>	0213W10A	12.611,13	15.763,91	2700K, white, Push
	0213W10APP	12.611,13	15.763,91	2700K, white, Push & Artemide APP
	0213010A	12.611,13	15.763,91	3000K, white, Push
	0213010APP	12.611,13	15.763,91	3000K, bianco, Push & Artemide APP
 <p>CALIPSO LINEAR 120 STAND-ALONE Neil Poulton Suspension lamp</p> <p>IP 20 LED 3000K, 43W, 2985lm, CRI=90 Dimmable (Push/DALI)</p> <p>LED 3000K, 43W, 2985lm, CRI=90 Dimmable (Push & APP)</p> <p>Materials: technopolymer</p>	0223010A	10.659,81	13.324,76	white, Push/DALI
	0223010APP	12.611,13	15.763,91	white, Push & Artemide APP
 <p>CALIPSO LINEAR 180 STAND-ALONE Neil Poulton Suspension lamp</p> <p>IP 20 LED 3000K, 63W, 4477lm, CRI=90 Dimmable (Push/DALI)</p> <p>LED 3000K, 63W, 4477lm, CRI=90 Dimmable (Push & APP)</p> <p>Materials: technopolymer</p>	0224010A	13.779,99	17.224,99	white, Push/DALI
	0224010APP	16.093,56	20.116,95	white, Push & Artemide APP
 <p>CALIPSO LINEAR SYSTEM SUSPENSION Neil Poulton Suspension system</p> <p>IP 20 Module 588mm: LED 3000K, 22W, 1492lm, CRI=90 Dimmable (Push/DALI)</p> <p>Module 1210mm: LED 3000K, 43W, 2985lm, CRI=90 Dimmable (Push/DALI)</p> <p>Module APP 1210mm: LED 3000K, 43W, 2985lm, CRI=90 Dimmable (APP)</p> <p>Module 1785mm: LED 3000K, 63W, 4477lm, CRI=90 Dimmable (Push/DALI)</p> <p>Module APP 1785mm: LED 3000K, 63W, 4477lm, CRI=90 Dimmable (APP)</p> <p>Materials: technopolymer</p>	2013010A	7.075,95	8.844,94	module 588mm, white, Push/DALI
	2014010A	10.099,53	12.624,41	module 1210mm, white, Push/DALI
	2014010APP	11.427,78	14.284,73	module 1210mm, white, Artemide APP-Master
	2015010A	13.731,69	17.164,61	module 1785mm, white, Push/DALI
	2015010APP	15.011,64	18.764,55	module 1785mm, white, Artemide APP-Master
	2022010A	970,83	1.213,54	kit end caps (2pcs)
	2023010A	1.081,92	1.352,40	joint 90° kit (right+left)
	2021010A	362,25	452,81	intermediate joint
	2024010A	362,25	452,81	connection cable
	2020010A	1.381,38	1.726,73	ceiling rose feeding kit (1 susp.cable+1 feed cable)
	2266010A	265,65	332,06	suspension cable (1 piece)
				The system, in APP operation, consists of a single APP Master module; subsequent modules, completing the system, must be DALI.


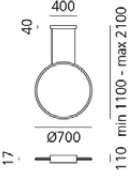


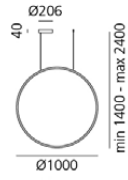
SUSPENSION LAMPS

	<p>CASTORE 14 SUSPENSION Michele De Lucchi, Huub Ubbens Suspension lamp</p> <p>IP 20 LED DIM 1x6W (E14)  Dimmable</p> <p>Materials: blown glass, polycarbonate</p>	1045110A	2.415,00	3.018,75	white
	<p>CASTORE 25 SUSPENSION Michele De Lucchi, Huub Ubbens Suspension lamp</p> <p>IP 20 LED DIM 1x15W (E27)  Dimmable</p> <p>Materials: blown glass, polycarbonate</p>	1053010A	4.303,53	5.379,41	white
	<p>CASTORE 35 SUSPENSION Michele De Lucchi, Huub Ubbens Suspension lamp</p> <p>IP 20 LED DIM 1x21W (E27)  Dimmable</p> <p>Materials: blown glass, polycarbonate</p>	1052010A	5.274,36	6.592,95	white
	<p>CASTORE 42 SUSPENSION Michele De Lucchi, Huub Ubbens Suspension lamp</p> <p>IP 20 LED DIM 1x21W (E27)  Dimmable</p> <p>Materials: blown glass, polycarbonate</p>	1051010A	6.042,33	7.552,91	white
	<p>CHLOROPHILIA Ross Lovegrove Suspension lamp</p> <p>IP 20 LED 3000K, 44W, 3146lm, CRI=90 Dimmable (Push & APP)</p> <p>Materials: methacrylate</p>	1628010APP	11.790,03	14.737,54	transparent, Push & Artemide APP
	<p>CHLOROPHILIA 2 Ross Lovegrove Suspension lamp</p> <p>IP 20 LED 3000K, 44W, 3146lm, CRI=90 Dimmable (Push & APP)</p> <p>Materials: methacrylate</p>	1628110APP	15.683,01	19.603,76	transparent, Push & Artemide APP

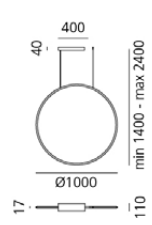
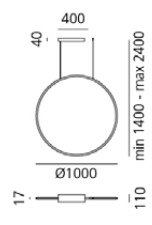
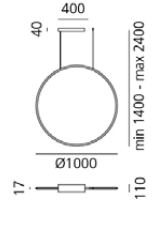
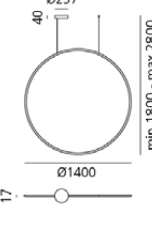
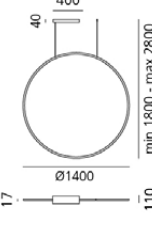
SUSPENSION LAMPS

 <p>ø130 50 max 2000 225 ø358</p>	<p>CHOOSE SUSPENSION</p> <p>Matteo Thun Suspension lamp</p> <p>IP 20 LED DIM 1x15W (E27)  Dimmable</p> <p>Materials: polycarbonate, parchment paper</p>	1123020A	3.791,55	4.739,44	parchment paper diffuser
	<p>1123110A</p>	3.791,55	4.739,44	white diffuser	
 <p>ø130 50 max 2000 370 ø550</p>	<p>CHOOSE MEGA SUSPENSION</p> <p>Matteo Thun Suspension lamp</p> <p>IP 20 LED DIM 3x15W (E27)  Dimmable</p> <p>Materials: polycarbonate, parchment paper</p>	1124020A	6.356,28	7.945,35	parchment paper diffuser
	<p>1124110A</p>	6.356,28	7.945,35	white diffuser	
 <p>max 2000 10 1040 410</p>	<p>COPERNICO SUSPENSION</p> <p>Carlotta de Bevilacqua, Paolo Dell'Elce Suspension lamp</p> <p>IP 20 LED 3000K, 30W, 3686lm, CRI=90 Dimmable (Push)</p> <p>Materials: aluminum</p>	1623010A	34.896,75	43.620,94	aluminium
	<p>1623020A</p>	36.476,16	45.595,20	black	
 <p>635 min 900 - max 2100 810 1770</p>	<p>COSMIC ANGEL SUSPENSION</p> <p>Ross Lovegrove Suspension lamp</p> <p>IP 20 LED DIM 2x11W (R7s)  Dimmable</p> <p>Materials: ABS, aluminum</p>	1513010A	28.033,32	35.041,65	polished chrome lighting units, aluminium reflector
	<p>DOI4600A02</p>	4.303,53	5.379,41	gold	
 <p>ø98 740 380 max 2740</p>	<p>DECOMPOSE' LIGHT SUSPENSION</p> <p>Atelier Oi Suspension lamp</p> <p>IP 20 LED 2x8W (E27)  Materials: aluminum</p>	DOI4600A03	4.303,53	5.379,41	orange
	DOI4600A16	4.303,53	5.379,41	red	
	DOI4600A80	4.303,53	5.379,41	smoked	
 <p>min 500 - max 1650 ø250 17 ø700</p>	<p>DISCOVERY SUSPENSION</p> <p>Ernesto Gismondi Suspension lamp</p> <p>IP 20 LED 3000K, 40W, 2857lm, CRI=90 Dimmable (Push)</p> <p>LED 3000K, 40W, 2857lm, CRI=90 Dimmable (Push & APP)</p> <p>Materials: technopolymer, aluminum</p>	1999110A	16.393,02	20.491,28	satinised aluminium, Push
	1999130A	16.393,02	20.491,28	black, Push	
	1999160A	16.393,02	20.491,28	bronze, Push	
	1999110APP	16.393,02	20.491,28	satinised aluminium, Push & Artemide APP	
	1999130APP	16.393,02	20.491,28	black, Push & Artemide APP	
	1999160APP	16.393,02	20.491,28	bronze, Push & Artemide APP	

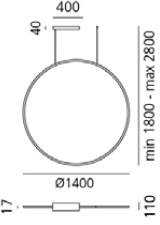
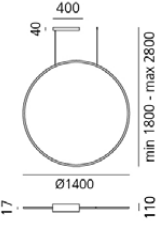
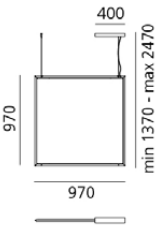
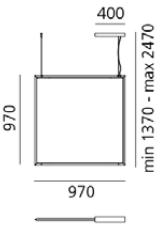
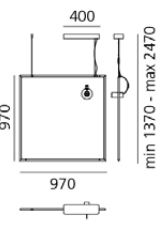
SUSPENSION LAMPS

 <p>Discovery Vertical 70 Suspension lamp diagram showing a circular lamp with a diameter of 206mm and a height of 40mm. The mounting arm has a diameter of 700mm. The lamp is shown in a side view and a top view.</p>	<p>DISCOVERY VERTICAL 70 SUSPENSION Ernesto Gismondi Suspension lamp</p> <p>IP 20 LED 3000K, 40W, 2857lm, CRI=90 Dimmable (Push/DALI)</p> <p>LED 3000K, 40W, 2857lm, CRI=90 Dimmable (Push & APP)</p> <p>Materials: technopolymer, aluminum</p>		1992010A	16.393,02	20.491,28	satinised aluminium, Push/DALI
	1992030A	16.393,02	20.491,28	black, Push/DALI		
	1992060A	16.393,02	20.491,28	bronze, Push/DALI		
	1992010APP	16.393,02	20.491,28	satinised aluminium, Push & Artemide APP		
	1992030APP	16.393,02	20.491,28	black, Push & Artemide APP		
	1992060APP	16.393,02	20.491,28	bronze, Push & Artemide APP		
 <p>Discovery Vertical 70 TW Suspension lamp diagram showing a circular lamp with a diameter of 400mm and a height of 40mm. The mounting arm has a diameter of 700mm. The lamp is shown in a side view and a top view.</p>	<p>DISCOVERY VERTICAL 70 TW SUSPENSION Ernesto Gismondi Suspension lamp</p> <p>IP 20 LED Strip 2700-6500K, 50W, warm 3246lm - cold 3343lm, CRI=80 Dimmable (DALI DT8)</p> <p>LED Strip 2700-6500K, 50W, warm 3246lm - cold 3343lm, CRI=80 Dimmable (APP)</p> <p>Materials: technopolymer, aluminum</p>		1992210A	23.058,42	28.823,03	TW: satinised aluminium, DALI DT8
	1992230A	23.058,42	28.823,03	TW: black, DALI DT8		
	1992260A	23.058,42	28.823,03	TW: bronze, DALI DT8		
	1992210APP	23.058,42	28.823,03	TW: satinised aluminium, Artemide APP		
	1992230APP	23.058,42	28.823,03	TW: black, Artemide APP		
	1992260APP	23.058,42	28.823,03	TW: bronze, Artemide APP		
 <p>Discovery Vertical 70 RGBW Suspension lamp diagram showing a circular lamp with a diameter of 400mm and a height of 40mm. The mounting arm has a diameter of 700mm. The lamp is shown in a side view and a top view.</p>	<p>DISCOVERY VERTICAL 70 RGBW SUSPENSION Ernesto Gismondi Suspension lamp</p> <p>IP 20 LED Strip RGB+W, 42W, RGB 871lm + W 1600lm, CRI=80 Dimmable (DALI)</p> <p>LED Strip RGB+W, 42W, RGB 871lm + W 1600lm, CRI=80 Dimmable (APP)</p> <p>Materials: technopolymer, aluminum</p>		1992310A	23.058,42	28.823,03	RGBW: satinised aluminium, DALI
	1992330A	23.058,42	28.823,03	RGBW: black, DALI		
	1992360A	23.058,42	28.823,03	RGBW: bronze, DALI		
	1992310APP	23.058,42	28.823,03	RGBW: satinised aluminium, Artemide APP		
	1992330APP	23.058,42	28.823,03	RGBW: black, Artemide APP		
	1992360APP	23.058,42	28.823,03	RGBW: bronze, Artemide APP		
 <p>Discovery Vertical 70 White Violet Integralis Suspension lamp diagram showing a circular lamp with a diameter of 400mm and a height of 40mm. The mounting arm has a diameter of 700mm. The lamp is shown in a side view and a top view.</p>	<p>DISCOVERY VERTICAL 70 WHITE VIOLET INTEGRALIS SUSPENSION Ernesto Gismondi Suspension lamp</p> <p>IP 20 LED Day mode 2700K, 42W, 1852lm, CRI= 80 LED Night mode 42W Dimmable (APP)</p> <p>Materials: technopolymer, aluminum</p>		1992210IN1APP	25.821,18	32.276,48	satinised aluminium, Artemide APP
	1992230IN1APP	25.821,18	32.276,48	black, Artemide APP		
	1992260IN1APP	25.821,18	32.276,48	bronze, Artemide APP		
 <p>Discovery Vertical 100 Suspension lamp diagram showing a circular lamp with a diameter of 206mm and a height of 40mm. The mounting arm has a diameter of 1000mm. The lamp is shown in a side view and a top view.</p>	<p>DISCOVERY VERTICAL 100 SUSPENSION Ernesto Gismondi Suspension lamp</p> <p>IP 20 LED 3000K, 60W, 4859lm, CRI=90 Dimmable (Push/DALI)</p> <p>LED 3000K, 60W, 4859lm, CRI=90 Dimmable (Push & APP)</p> <p>Materials: technopolymer, aluminum</p>		1993010A	22.797,60	28.497,00	satinised aluminium, Push/DALI
	1993030A	22.797,60	28.497,00	black, Push/DALI		
	1993060A	22.797,60	28.497,00	bronze, Push/DALI		
	1993010APP	22.797,60	28.497,00	satinised aluminium, Push & Artemide APP		
	1993030APP	22.797,60	28.497,00	black, Push & Artemide APP		
	1993060APP	22.797,60	28.497,00	bronze, Push & Artemide APP		

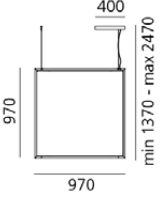
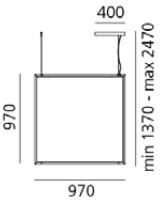
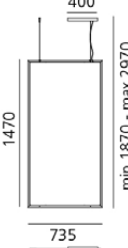
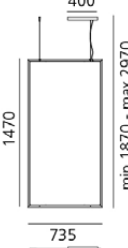
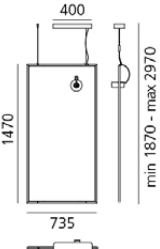
SUSPENSION LAMPS

 <p>DISCOVERY VERTICAL 100 TW SUSPENSION Ernesto Gismondi Suspension lamp</p> <p>IP 20 LED Strip 2700-6500K, 71W, warm 4637lm - cold 4775lm, CRI=80 Dimmable (DALI DT8)</p> <p>LED Strip 2700-6500K, 71W, warm 4637lm - cold 4775lm, CRI=80 Dimmable (APP)</p> <p>Materials: technopolymer, aluminum</p>	1993210A	32.076,03	40.095,04	TW: satinised aluminium, DALI DT8
	1993230A	32.076,03	40.095,04	TW: black, DALI DT8
	1993260A	32.076,03	40.095,04	TW: bronze, DALI DT8
	1993210APP	32.076,03	40.095,04	TW: satinised aluminium, Artemide APP
	1993230APP	32.076,03	40.095,04	TW: black, Artemide APP
	1993260APP	32.076,03	40.095,04	TW: bronze, Artemide APP
 <p>DISCOVERY VERTICAL 100 RGBW SUSPENSION Ernesto Gismondi Suspension lamp</p> <p>IP 20 LED Strip RGB+W, 59W, RGB 1106lm + W 2033lm, CRI=80 Dimmable (DALI)</p> <p>LED Strip RGB+W, 59W, RGB 1106lm + W 2033lm, CRI=80 Dimmable (APP)</p> <p>Materials: technopolymer, aluminum</p>	1993310A	32.076,03	40.095,04	RGBW: satinised aluminium, DALI
	1993330A	32.076,03	40.095,04	RGBW: black, DALI
	1993360A	32.076,03	40.095,04	RGBW: bronze, DALI
	1993310APP	32.076,03	40.095,04	RGBW: satinised aluminium, Artemide APP
	1993330APP	32.076,03	40.095,04	RGBW: black, Artemide APP
	1993360APP	32.076,03	40.095,04	RGBW: bronze, Artemide APP
 <p>DISCOVERY VERTICAL 100 WHITE VIOLET INTEGRALIS SUSPENSION Ernesto Gismondi Suspension lamp</p> <p>IP 20 LED Day mode 2700K, 60W, 2646lm, CRI= 80 LED Night mode 60W Dimmable (APP)</p> <p>Materials: technopolymer, aluminum</p>	1993210IN1APP	35.920,71	44.900,89	satinised aluminium, Artemide APP
	1993230IN1APP	35.920,71	44.900,89	black, Artemide APP
	1993260IN1APP	35.920,71	44.900,89	bronze, Artemide APP
 <p>DISCOVERY VERTICAL 140 SUSPENSION Ernesto Gismondi Suspension lamp</p> <p>IP 20 LED 3000K, 80W, 6762lm, CRI=90 Dimmable (Push/DALI)</p> <p>LED 3000K, 80W, 6762lm, CRI=90 Dimmable (Push & APP)</p> <p>Materials: technopolymer, aluminum</p>	1994010A	32.486,58	40.608,23	satinised aluminium, Push/DALI
	1994030A	32.486,58	40.608,23	black, Push/DALI
	1994060A	32.486,58	40.608,23	bronze, Push/DALI
	1994010APP	32.486,58	40.608,23	satinised aluminium, Push & Artemide APP
	1994030APP	32.486,58	40.608,23	black, Push & Artemide APP
	1994060APP	32.486,58	40.608,23	bronze, Push & Artemide APP
 <p>DISCOVERY VERTICAL 140 TW SUSPENSION Ernesto Gismondi Suspension lamp</p> <p>IP 20 LED Strip 2700-6500K, 84W, warm 5487lm - cold 5650lm, CRI=80 Dimmable (DALI DT8)</p> <p>LED Strip 2700-6500K, 84W, warm 5487lm - cold 5650lm, CRI=80 Dimmable (APP)</p> <p>Materials: technopolymer, aluminum</p>	1994210A	36.476,16	45.595,20	TW: satinised aluminium, DALI DT8
	1994230A	36.476,16	45.595,20	TW: black, DALI DT8
	1994260A	36.476,16	45.595,20	TW: bronze, DALI DT8
	1994210APP	36.476,16	45.595,20	TW: satinised aluminium, Artemide APP
	1994230APP	36.476,16	45.595,20	TW: black, Artemide APP
	1994260APP	36.476,16	45.595,20	TW: bronze, Artemide APP

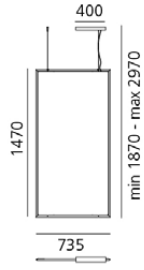
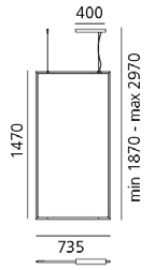
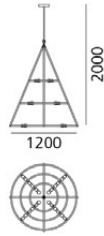
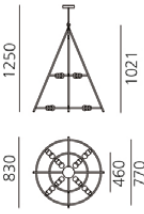


SUSPENSION LAMPS

 <p>Discovery Vertical 140 RGBW Suspension lamp</p> <p>Ernesto Gismondi Suspension lamp</p> <p>IP 20 LED Strip RGB+W, 79W, RGB 1453lm + W 2670lm, CRI=80 Dimmable (DALI)</p> <p>LED Strip RGB+W, 79W, RGB 1453lm + W 2670lm, CRI=80 Dimmable (APP)</p> <p>Materials: technopolymer, aluminum</p>	1994310A	36.476,16	45.595,20	RGBW: satinised aluminium, DALI
	1994330A	36.476,16	45.595,20	RGBW: black, DALI
	1994360A	36.476,16	45.595,20	RGBW: bronze, DALI
	1994310APP	36.476,16	45.595,20	RGBW: satinised aluminium, Artemide APP
	1994330APP	36.476,16	45.595,20	RGBW: black, Artemide APP
	1994360APP	36.476,16	45.595,20	RGBW: bronze, Artemide APP
 <p>Discovery Vertical 140 White Violet Integralis Suspension lamp</p> <p>Ernesto Gismondi Suspension lamp</p> <p>IP 20 LED Day mode 2700K, 84W, 3704lm, CRI= 80 LED Night mode 84W Dimmable (APP)</p> <p>Materials: technopolymer, aluminum</p>	1994210IN1APP	40.895,61	51.119,51	satinised aluminium, Artemide APP
	1994230IN1APP	40.895,61	51.119,51	black, Artemide APP
	1994260IN1APP	40.895,61	51.119,51	bronze, Artemide APP
 <p>Discovery Space Square Suspension lamp</p> <p>Ernesto Gismondi Suspension lamp</p> <p>IP 20 LED Strip, 3000K, 34W, 1955lm, CRI=90 Dimmable (Push/DALI)</p> <p>LED Strip, 3000K, 34W, 1955lm, CRI=90 Dimmable (Push & APP)</p> <p>Materials: technopolymer, aluminum</p>	2004010A	21.778,47	27.223,09	Square white: satinised aluminium, Push/DALI
	2004030A	21.778,47	27.223,09	Square white: black, Push/DALI
	2004060A	21.778,47	27.223,09	Square white: bronze, Push/DALI
	2004010APP	21.778,47	27.223,09	Square white: satinised aluminium, Push & Artemide APP
	2004030APP	21.778,47	27.223,09	Square white: black, Push & Artemide APP
	2004060APP	21.778,47	27.223,09	Square white: bronze, Push & Artemide APP
 <p>Discovery Space Square TW Suspension lamp</p> <p>Ernesto Gismondi Suspension lamp</p> <p>IP 20 LED Strip 2700-6500K 44W, warm 2579lm - cold 2739lm, CRI=80 Dimmable (DALI DT8)</p> <p>LED Strip 2700-6500K 44W, warm 2579lm - cold 2739lm, CRI=80 Dimmable (APP)</p> <p>Materials: technopolymer, aluminum</p>	2000010A	32.076,03	40.095,04	Square TW: satinised aluminium, DALI DT8
	2000030A	32.076,03	40.095,04	Square TW: black, DALI DT8
	2000060A	32.076,03	40.095,04	Square TW: bronze; DALI DT8
	2000010APP	32.076,03	40.095,04	Square TW: satinised aluminium, Artemide APP
	2000030APP	32.076,03	40.095,04	Square TW: black, Artemide APP
	2000060APP	32.076,03	40.095,04	Square TW: bronze, Artemide APP
 <p>Discovery Space Square Spot TW Suspension lamp</p> <p>Ernesto Gismondi Suspension lamp</p> <p>IP 20 LED Strip 2700-6500K 42W, warm 2580lm - cold 2749lm, CRI=80 + Spot: LED 3000K, 23W, 1703lm(16°), 1721lm (22°) Dimmable (APP)</p> <p>Materials: technopolymer, aluminum</p>	2030030APP	25.473,42	31.841,78	black, Artemide APP


SUSPENSION LAMPS


 <p>400 970 min 1370 - max 2470</p> <p>DISCOVERY SPACE SQUARE RGBW Ernesto Gismondi Suspension lamp</p> <p>IP 20 LED Strip RGBW, 36W, RGB 621lm + 1087lm, CRI=80 Dimmable (DALI)</p> <p>LED Strip RGBW, 36W, RGB 621lm + 1087lm, CRI=80 Dimmable (APP)</p> <p>Materials: technopolymer, aluminum</p>	2001010A	32.076,03	40.095,04	Square RGBW: satinised aluminium, DALI
	2001030A	32.076,03	40.095,04	Square RGBW: black, DALI
	2001060A	32.076,03	40.095,04	Square RGBW: bronze, DALI
	2001010APP	32.076,03	40.095,04	Square RGBW: satinised aluminium, Artemide APP
	2001030APP	32.076,03	40.095,04	Square RGBW: black, Artemide APP
	2001060APP	32.076,03	40.095,04	Square RGBW: bronze, Artemide APP
 <p>400 970 min 1370 - max 2470</p> <p>DISCOVERY SPACE SQUARE WHITE VIOLET INTEGRALIS Ernesto Gismondi Suspension lamp</p> <p>IP 20 LED Day mode 2700K, 42W, 1852lm, CRI= 80 LED Night mode 42W Dimmable (APP)</p> <p>Materials: technopolymer, aluminum</p>	2000010IN1APP	34.635,93	43.294,91	Square Integralis: satinised aluminium, Artemide APP
	2000030IN1APP	34.635,93	43.294,91	Square Integralis: black, Artemide APP
	2000060IN1APP	34.635,93	43.294,91	Square Integralis: bronze, Artemide APP
 <p>400 1470 min 1870 - max 2970</p> <p>DISCOVERY SPACE RECTANGULAR Ernesto Gismondi Suspension lamp</p> <p>IP 20 LED Strip 3000K, 52W, 4003lm, CRI=90 Dimmable (Push/DALI)</p> <p>LED Strip 3000K, 52W, 4003lm, CRI=90 Dimmable (Push & APP)</p> <p>Materials: technopolymer, aluminum</p>	2005010A	25.009,74	31.262,18	Rect. white: satinised aluminium, Push/DALI
	2005030A	25.009,74	31.262,18	Rect. white: black, Push/DALI
	2005060A	25.009,74	31.262,18	Rect. white: bronze, Push/DALI
	2005010APP	25.009,74	31.262,18	Rect. white: satinised aluminium, Push & Artemide APP
	2005030APP	25.009,74	31.262,18	Rect. white: black, Push & Artemide APP
	2005060APP	25.009,74	31.262,18	Rect. white: bronze, Push & Artemide APP
 <p>400 1470 min 1870 - max 2970</p> <p>DISCOVERY SPACE RECTANGULAR TW Ernesto Gismondi Suspension lamp</p> <p>IP 20 LED Strip 2700-6500K, 62W, warm 3555lm - cold 3775lm, CRI=80 Dimmable (DALI DT8)</p> <p>LED Strip 2700-6500K, 62W, warm 3555lm - cold 3775lm, CRI=80 Dimmable (APP)</p> <p>Materials: technopolymer, aluminum</p>	2002010A	37.707,81	47.134,76	Rect. TW: satinised aluminium, DALI DT8
	2002030A	37.707,81	47.134,76	Rect. TW: black, DALI DT8
	2002060A	37.707,81	47.134,76	Rect. TW: bronze, DALI DT8
	2002010APP	37.707,81	47.134,76	Rect. TW: satinised aluminium, Artemide APP
	2002030APP	37.707,81	47.134,76	Rect. TW: black, Artemide APP
	2002060APP	37.707,81	47.134,76	Rect. TW: bronze, Artemide APP
 <p>400 1470 min 1870 - max 2970</p> <p>DISCOVERY SPACE RECTANGULAR SPOT TW Ernesto Gismondi Suspension lamp</p> <p>IP 20 LED Strip 2700-6500K 57W, warm 3557lm - cold 3789lm, CRI=80 + Spot: LED 3000K, 23W, 1703lm (16°), 1721lm (22°) Dimmable (APP)</p> <p>Materials: technopolymer, aluminum</p>	2031030APP	31.105,20	38.881,50	black, Artemide APP

SUSPENSION LAMPS


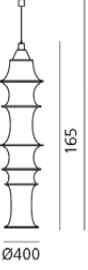








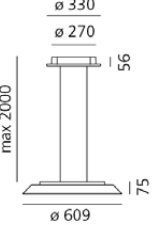
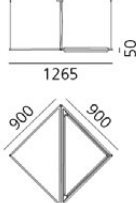
 <p>400 1470 min 1870 - max 2970 735</p>	<p>DISCOVERY SPACE RECTANGULAR RGBW Ernesto Gismondi Suspension lamp</p>		2003010A	35.196,21	43.995,26	Rect. RGBW: satinised aluminium, DALI
			2003030A	35.196,21	43.995,26	Rect. RGBW: black, DALI
			2003060A	35.196,21	43.995,26	Rect. RGBW: bronze, DALI
			2003010APP	35.196,21	43.995,26	Rect. RGBW: satinised aluminium, Artemide APP
			2003030APP	35.196,21	43.995,26	Rect. RGBW: black, Artemide APP
			2003060APP	35.196,21	43.995,26	Rect. RGBW: bronze, Artemide APP
 <p>400 1470 min 1870 - max 2970 735</p>	<p>DISCOVERY SPACE RECTANGULAR WHITE VIOLET INTEGRALIS Ernesto Gismondi Suspension lamp</p>		2002010IN1APP	40.895,61	51.119,51	Rect. Integralis: satinised aluminium, Artemide APP
			2002030IN1APP	40.895,61	51.119,51	Rect. Integralis: black, Artemide APP
			2002060IN1APP	40.895,61	51.119,51	Rect. Integralis: bronze, Artemide APP
 <p>2000 1200</p>	<p>EL PORIS Herzog & de Meuron Suspension lamp</p>		1085030A	39.040,89	48.801,11	black
 <p>1250 1021 830 460 770</p>	<p>EL PORIS 80 Herzog & de Meuron Suspension lamp</p>		1086030A	28.545,30	35.681,63	black
 <p>min 500 - max 2000 ø160</p>	<p>EMPATIA 16 SUSPENSION Carlotta de Bevilacqua, Paola di Arianello Suspension lamp</p>		1815010A	7.834,26	9.792,83	transparent smoked diffuser, white structure
 <p>min 500 - max 2100 ø260</p>	<p>EMPATIA 26 SUSPENSION Carlotta de Bevilacqua, Paola di Arianello Suspension lamp</p>		1819010A	11.331,18	14.163,98	transparent smoked diffuser, white structure

LED Not replaceable integrated LED source

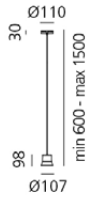
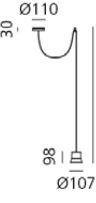
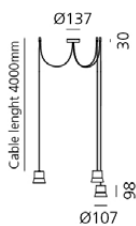
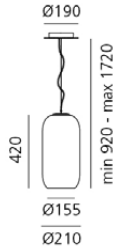

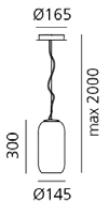

 Included source

 Excluded source

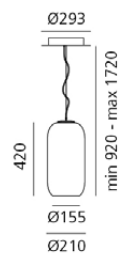

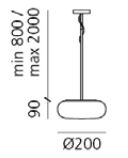


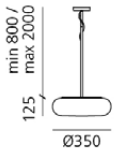


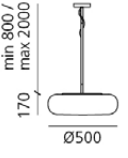


SUSPENSION LAMPS

 <p>min 500 - max 2200 ø360</p>	<p>EMPATIA 36 SUSPENSION Carlotta de Bevilacqua, Paola di Arianello Suspension lamp</p> <p>IP 20 LED 3000K, 24W, 1273lm, CRI=90 Dimmable (Push)</p> <p>Materials: blown glass, methacrylate, aluminum</p>	<p>1823010A</p>	<p>14.552,79</p>	<p>18.190,99</p>	<p>transparent smoked diffuser, white structure</p>
 <p>165 max 3000 Ø400</p>	<p>FALKLAND Bruno Munari Suspension lamp</p> <p>IP 20 LED DIM 1x8W (E27)  Dimmable</p> <p>Materials: elastic fabric, aluminum</p>	<p> DS2040RIF DS2040CRC DS2040CRCI</p>	<p>1.618,05 1.569,75 1.618,05</p>	<p>2.022,56 1.962,19 2.022,56</p>	<p>aluminium grey structure fabric 165 + inox hoops fireproof fabric 165 + inox hoops</p> <p>Complete lamp consists of 2 items.</p>
 <p>85 max 2000 Ø400</p>	<p>FALKLAND 85 Bruno Munari Suspension lamp</p> <p>IP 20 LED DIM 1x8W (E27)  Dimmable</p> <p>Materials: elastic fabric, aluminum</p>	<p> DS2040RIF DS2040CCRC DS2040CCRCI</p>	<p>1.618,05 990,15 1.050,53</p>	<p>2.022,56 1.237,69 1.313,16</p>	<p>aluminium grey structure fabric 85 + metal hoops inox fireproof fabric 85 + metal hoops inox</p> <p>Complete lamp consists of 2 items.</p>
 <p>53 max 2000 Ø400</p>	<p>FALKLAND 53 Bruno Munari Suspension lamp</p> <p>IP 20 LED DIM 1x8W (E27)  Dimmable</p> <p>Materials: elastic fabric, aluminum</p>	<p> DS2040RIF DS2040DCRC DS2040DCRCI</p>	<p>1.618,05 833,18 893,55</p>	<p>2.022,56 1.041,47 1.116,94</p>	<p>aluminium grey structure fabric 53 + metal hoops inox fireproof fabric 53 + metal hoops inox</p> <p>Complete lamp consists of 2 items.</p>
 <p>ø 330 ø 270 56 max 2000 ø 609 75</p>	<p>FEBE SUSPENSION Ernesto Gismondi, Daniele Moioli Suspension lamp</p> <p>IP 20 LED 2700K, 30W, 2182lm, CRI=90 Dimmable (Push)</p> <p>LED 3000K, 30W, 2260lm, CRI=90 Dimmable (Push)</p> <p>Materials: methacrylate, polycarbonate</p>	<p>0242W00A 0242000A 0242W20A 0242020A</p>	<p>9.688,98 9.688,98 9.688,98 9.688,98</p>	<p>12.111,23 12.111,23 12.111,23 12.111,23</p>	<p>2700K, white 3000K, white 2700K, dove grey 3000K, dove grey</p>
 <p>50 1265 900 900</p>	<p>FLEXIA SUSPENSION Mario Cucinella Suspension lamp</p> <p>IP 20 LED 3000K, 65W, 6475lm, CRI=90 Dimmable (Push/1-10/DALI)</p> <p>LED 3000K, 65W, 6475lm, CRI=90 Dimmable (Push & APP)</p> <p>Materials: PMMA, aluminum, polyester</p>	<p>CC10000 CC10300 CC10400 CC90000 CC90000APP</p>	<p>25.743,90 25.743,90 25.743,90 5.047,35 5.047,35</p>	<p>32.179,88 32.179,88 32.179,88 6.309,19 6.309,19</p>	<p>green light blue orange ceiling rose ceiling rose, Artemide APP</p>

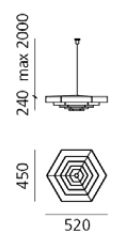


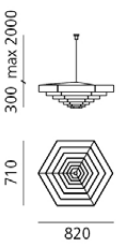


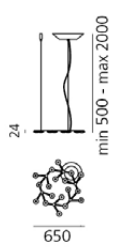

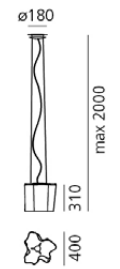

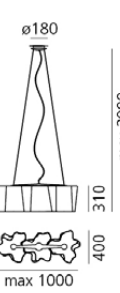

SUSPENSION LAMPS

	<p>GIO LIGHT SUSPENSION Patrick Norguet Suspension lamp</p> <p>IP 20 LED 3000K, 9W, 425lm, CRI=90</p> <p>Materials: aluminum, glass</p>	0230510A	3.173,31	3.966,64	white
		0230520A	3.173,31	3.966,64	black
	<p>GIO LIGHT DECENTRATA Patrick Norguet Suspension lamp</p> <p>IP 20 LED 3000K, 9W, 425lm, CRI=90</p> <p>Materials: aluminum, glass</p>	0231510A	3.694,95	4.618,69	white
		0231520A	3.694,95	4.618,69	black
	<p>GIO LIGHT CLUSTER Patrick Norguet Suspension lamp</p> <p>IP 20 LED 3000K, 23W, 1274lm, CRI=90</p> <p>Materials: aluminum, glass</p>	0232510A	8.505,63	10.632,04	white
		0232520A	8.505,63	10.632,04	black
	<p>GOPLE SUSPENSION BIG Suspension lamp</p> <p>IP 20 LED DIM 1x20W (E27)  Dimmable</p> <p>Materials: aluminum, white blown glass with nuances or blown glass with PVD treatment</p>	1405010A	10.239,60	12.799,50	structure and diffuser silver PVD
		1405020A	8.409,03	10.511,29	silver structure and nuanced white diffuser
		1405040A	10.239,60	12.799,50	silver structure and copper diffuser PVD
		1405050A	10.239,60	12.799,50	silver structure and blue sapphire diffuser PVD
		1405060A	10.239,60	12.799,50	silver structure and bronze diffuser PVD
		1405220A	8.297,94	10.372,43	white structure and nuanced white diffuser
		1405340A	10.143,00	12.678,75	black structure and copper diffuser PVD
		1405350A	10.143,00	12.678,75	black structure and blue sapphire diffuser PVD
		1405360A	10.143,00	12.678,75	black structure and bronze diffuser PVD
	<p>GOPLE MINI SUSPENSION BIG Suspension lamp</p> <p>IP 20 LED DIM 1x6W (E14)  Dimmable</p> <p>Materials: aluminum, white blown glass with nuances or blown glass with PVD treatment</p>	1406010A	6.013,35	7.516,69	structure and diffuser silver PVD
		1406020A	5.076,33	6.345,41	silver structure and nuanced white diffuser
		1406040A	6.013,35	7.516,69	silver structure and copper diffuser PVD
		1406050A	6.013,35	7.516,69	silver structure and blue sapphire diffuser PVD
		1406060A	6.013,35	7.516,69	silver structure and bronze diffuser PVD
		1406220A	4.974,90	6.218,63	white structure and nuanced white diffuser
		1406340A	5.904,68	7.380,84	black structure and copper diffuser PVD
		1406350A	5.904,68	7.380,84	black structure and blue sapphire diffuser PVD
		1406360A	5.904,68	7.380,84	black structure and bronze diffuser PVD

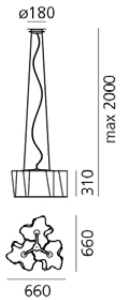

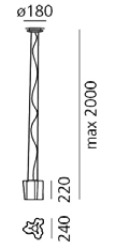

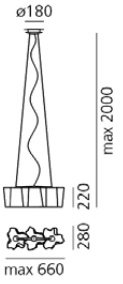

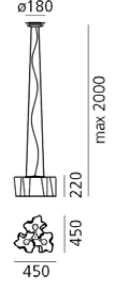

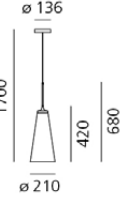
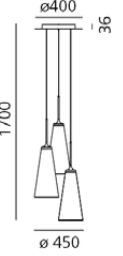
SUSPENSION LAMPS

 <p>GOPLE RWB SUSPENSION BIG Suspension lamp</p> <p>IP 20 direct: LED RWB, 21W, 1170lm + indirect: LED 3000K, 11W, 600lm, CRI=90 Dimmable (DALI)</p> <p>direct: LED RWB, 21W, 1170lm + indirect: LED 3000K, 11W, 600lm, CRI=90 Dimmable (APP)</p> <p>direct: LED RWB, 21W, 1170lm + indirect: LED 3000K, 11W, 600lm, CRI=90 Dimmable (DMX)</p> <p>Materials: aluminum, blown glass</p>	1407010A	20.348,79	25.435,99	RWB/DALI: white diffuser
	1407010APP	19.363,47	24.204,34	RWB/APP: white diffuser, Artemide APP
	1407110A	20.034,84	25.043,55	RWB/DMX: white diffuser
 <p>IPNO SUSPENSION Michele De Lucchi Suspension lamp</p> <p>IP 20 LED 3000K, 27W, 1163lm, CRI=90 Dimmable (Push)</p> <p>Materials: aluminum, methacrylate</p>	1846030A	10.099,53	12.624,41	transparent optic, gold/black structure
 <p>ITKA 20 SUSPENSION Naoto Fukasawa Suspension lamp</p> <p>IP 20 LED 1x5W (Gx53) </p> <p>Materials: blown glass, steel</p>	 DX0060O10	3.864,00	4.830,00	white
 <p>ITKA 35 SUSPENSION Naoto Fukasawa Suspension lamp</p> <p>IP 20 LED 3x4W (E14) </p> <p>Materials: blown glass, steel</p>	 DX0060A10	6.109,95	7.637,44	white
 <p>ITKA 50 SUSPENSION Naoto Fukasawa Suspension lamp</p> <p>IP 20 LED 3x8W (E27) </p> <p>Materials: blown glass, steel</p>	 DX0060B10	8.198,93	10.248,66	white

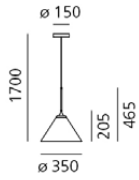
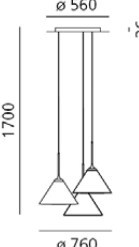
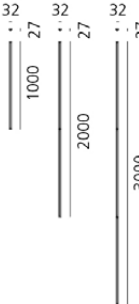
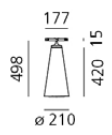
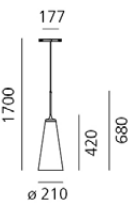
SUSPENSION LAMPS

 <p>LAMPADA ESAGONALE 52 Bruno Munari Suspension lamp</p> <p>IP 20 LED DIM 1x8W (E27)  Dimmable</p> <p>Materials: aluminum</p>		DM2004A00	6.737,85	8.422,31	aluminium
		DM2004A10	6.737,85	8.422,31	white
 <p>LAMPADA ESAGONALE 82 Bruno Munari Suspension lamp</p> <p>IP 20 LED DIM 1x8W (E27)  Dimmable</p> <p>Materials: aluminum</p>		DM2004B00	9.768,68	12.210,84	aluminium
		DM2004B10	9.768,68	12.210,84	white
 <p>LED NET CIRCLE SUSPENSION Michele De Lucchi, Alberto Nason Suspension lamp</p> <p>IP 20 LED 3000K, 43W, 2502lm, CRI=80 Dimmable (Push & APP)</p> <p>Materials: aluminum, methacrylate</p>		1575050APP	18.803,19	23.503,99	glossy white, Push & Artemide APP
 <p>LED NET LINE 125 SUSPENSION Michele De Lucchi, Alberto Nason Suspension lamp</p> <p>IP 20 LED 3000K, 45W, 2530lm, CRI=80 Dimmable (Push & APP)</p> <p>Materials: aluminum, methacrylate</p>		1578050APP	19.527,69	24.409,61	glossy white, Push & Artemide APP
 <p>LOGICO SUSPENSION Michele De Lucchi, Gerhard Reichert Suspension lamp</p> <p>IP 20 LED DIM 1x15W (E27)  Dimmable</p> <p>Materials: blown glass, aluminum</p>		0453020A	10.297,56	12.871,95	glass with silk effect diffuser
		0453010A	10.297,56	12.871,95	fumé glass diffuser
 <p>LOGICO SUSPENSION 3 in linea Michele De Lucchi, Gerhard Reichert Suspension lamp</p> <p>IP 20 LED DIM 3x15W (E27)  Dimmable</p> <p>Materials: blown glass, aluminum</p>		0455020A	27.163,92	33.954,90	glass with silk effect diffusers
		0455010A	27.163,92	33.954,90	smoked glass diffusers


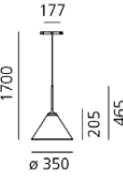

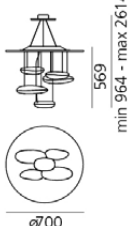




SUSPENSION LAMPS

	<p>LOGICO SUSPENSION 3x120° Michele De Lucchi, Gerhard Reichert Suspension lamp</p> <p>IP 20 LED DIM 3x15W (E27)  Dimmable</p> <p>Materials: blown glass, aluminum</p>	0454020A	26.294,52	32.868,15	glass with silk effect diffusers
		0454010A	26.294,52	32.868,15	smoked glass diffusers
	<p>LOGICO MINI SUSPENSION Michele De Lucchi, Gerhard Reichert Suspension lamp</p> <p>IP 20 LED DIM 1x10W (E27)  Dimmable</p> <p>Materials: blown glass, aluminum</p>	0696020A	6.404,58	8.005,73	glass with silk effect diffusers
	<p>LOGICO MINI SUSPENSION 3 in linea Michele De Lucchi, Gerhard Reichert Suspension lamp</p> <p>IP 20 LED DIM 3x10W (E27)  Dimmable</p> <p>Materials: blown glass, aluminum</p>	0697020A	15.832,74	19.790,93	glass with silk effect diffusers
	<p>LOGICO MINI SUSPENSION 3x120° Michele De Lucchi, Gerhard Reichert Suspension lamp</p> <p>IP 20 LED DIM 3x10W (E27)  Dimmable</p> <p>Materials: blown glass, aluminum</p>	0698020A	15.272,46	19.090,58	glass with silk effect diffusers
	<p>LOOK AT ME 21 SUSPENSION Alida Catella & Silvio De Ponte Suspension lamp</p> <p>IP 20 LED 3000K, 20W, 478lm, CRI=90 Dimmable (Push)</p> <p>Materials: methacrylate, aluminium, steel</p>	1450010A	7.423,71	9.279,64	black structure and diffuser, Push
	<p>LOOK AT ME 21 CLUSTER Alida Catella & Silvio De Ponte Suspension lamp</p> <p>IP 20 LED 3000K, 50W, 1380lm, CRI=90 Dimmable (Push/APP)</p> <p>Materials: methacrylate, aluminium, steel</p>	1452010APP	20.034,84	25.043,55	black structure and diffuser, Push & Artemide APP

SUSPENSION LAMPS

 <p>LOOK AT ME 35 SUSPENSION Alida Catella & Silvio De Ponte Suspension lamp</p> <p>IP 20 LED 3000K, 20W, 692lm, CRI=90 Dimmable (Push)</p> <p>Materials: methacrylate, aluminium, steel</p>	1451010A	8.708,49	10.885,61	black structure and diffuser, Push
 <p>LOOK AT ME 35 CLUSTER Alida Catella & Silvio De Ponte Suspension lamp</p> <p>IP 20 LED 3000K, 50W, 1905lm, CRI=90 Dimmable (Push/APP)</p> <p>Materials: methacrylate, aluminium, steel</p>	1453010APP	21.266,49	26.583,11	black structure and diffuser, Push & Artemide APP
 <p>LOOK AT ME 21 TRACK SUSPENSION SYSTEM Alida Catella & Silvio De Ponte</p>	1459100A	2.361,87	2.952,34	track length 1mt.
	1459200A	4.042,71	5.053,39	track length 2mt.
	1459300A	5.684,91	7.106,14	track length 3mt.
	1458500A	8.708,49	10.885,61	accessory: ceiling rose, DALI/0-10/Push
	1458500APP	8.708,49	10.885,61	accessory: ceiling rose, Artemide APP
	1458200A	2.361,87	2.952,34	accessory: flexible powered joint
	1458300A	869,40	1.086,75	accessory: linear powered joint
	1458400A	772,80	966,00	accessory: suspension kit
	1458700A	970,83	1.213,54	accessory: ceiling fixing kit
	1458600A	8.708,49	10.885,61	accessory: recessed rose, DALI/0-10/Push
	1458600APP	8.708,49	10.885,61	accessory: recessed rose, Artemide APP
 <p>LOOK AT ME 21 TRACK SUSPENSION Alida Catella & Silvio De Ponte Suspension lamp</p> <p>IP 20 LED 3000K, 20W, 478lm, CRI=90 Dimmable (DART)</p> <p>Materials: methacrylate, aluminium, steel</p>	1454010A	7.177,38	8.971,73	black structure and diffuser, DART
 <p>LOOK AT ME 21 TRACK SUSPENSION Alida Catella & Silvio De Ponte Track suspension system</p> <p>IP 20 LED 3000K, 20W, 478lm, CRI=90 Dimmable (DART)</p> <p>Materials: methacrylate, aluminium, steel</p>	1456010A	8.046,78	10.058,48	black structure and diffuser, DART



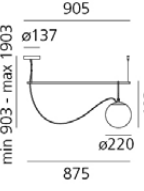

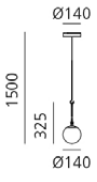

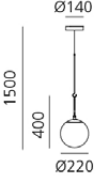

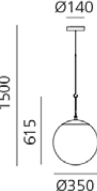

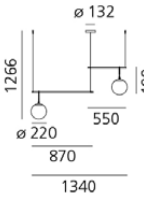

SUSPENSION LAMPS

 <p>LOOK AT ME 35 TRACK Alida Catella & Silvio De Ponte Suspension lamp</p> <p>IP 20 LED 3000K, 20W, 692lm, CRI=90 Dimmable (DART)</p> <p>Materials: methacrylate, aluminium, steel</p>	1455010A	8.409,03	10.511,29	black structure and diffuser, DART
 <p>LOOK AT ME 35 TRACK SUSPENSION Alida Catella & Silvio De Ponte Track suspension system</p> <p>IP 20 LED 3000K, 20W, 692lm, CRI=90 Dimmable (DART)</p> <p>Materials: methacrylate, aluminium, steel</p>	1457010A	9.428,16	11.785,20	black structure and diffuser, DART
 <p>MERCURY LED SUSPENSION Ross Lovegrove Suspension lamp</p> <p>IP 20 LED 2700K, 2x29W, 2893lm, CRI=90 Dimmable (Push)</p> <p>LED 3000K, 2x29W, 3094lm, CRI=90 Dimmable (Push)</p> <p>Materials: aluminum, ABS, steel</p>	1367W10A	35.606,76	44.508,45	2700K, polished chrome brilliant
	1367110A	35.606,76	44.508,45	3000K, polished chrome brilliant
 <p>MERCURY MINI LED SUSPENSION Ross Lovegrove Suspension lamp</p> <p>IP 20 LED 2700K, 29W, 1447lm, CRI=90 Dimmable (Push)</p> <p>LED 3000K, 29W, 1547lm, CRI=90 Dimmable (Push)</p> <p>Materials: aluminum, ABS, steel</p>	1477W10A	17.735,76	22.169,70	2700K, polished chrome brilliant
	1477110A	17.735,76	22.169,70	3000K, polished chrome brilliant
 <p>METEORITE 15 SUSPENSION Pio & Tito Toso Suspension lamp</p> <p>IP 20 LED DIM 1x6W (E14)  Dimmable</p> <p>Materials: blown glass, technopolymer</p>	1710110A	3.173,31	3.966,64	(E14): white
 <p>METEORITE 35 SUSPENSION Pio & Tito Toso Suspension lamp</p> <p>IP 20 LED DIM 1x21W (E27)  Dimmable</p> <p>Materials: blown glass, technopolymer</p>	1702010A	5.796,00	7.245,00	white

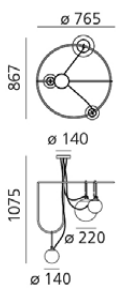
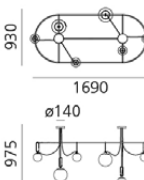
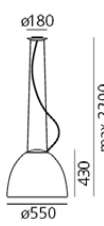
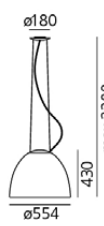
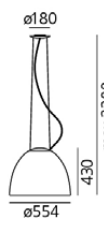
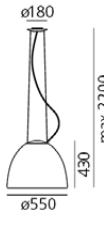
SUSPENSION LAMPS

	<p>METEORITE 48 SUSPENSION Pio & Tito Toso Suspension lamp</p> <p>IP 20 LED DIM 1x21W (E27) Dimmable</p> <p>Materials: blown glass, technopolymer</p>	1713010A	9.114,21	11.392,76	white
	<p>MICONOS SUSPENSION Ernesto Gismondi Suspension lamp</p> <p>IP 20 LED DIM 1x15W (E27) Dimmable</p> <p>Materials: blown glass, steel</p>	A031000	5.994,03	7.492,54	crystal diffuser, polished chrome structure
		A031010	5.994,03	7.492,54	crystal diffuser, brass satinised structure
	<p>MINOMUSHI SUSPENSION </p> <p>Issey Miyake + Reality Lab IN-EI suspension lamp</p> <p>IP 20 LED 3000K, 30W, 2527lm, CRI=90 Dimmable (Push)</p> <p>Materials: PET, methacrylate, steel, polycarbonate</p>	1697010A	17.933,79	22.417,24	white
	<p>nh S1 14 Neri&Hu Suspension lamp</p> <p>IP 20 LED DIM 1x5W (E14) Dimmable</p> <p>Materials: blown glass, brass, steel</p>	1272010A	4.612,65	5.765,81	white diffuser, brushed brass body, black structure
	<p>nh S2 14 Neri&Hu Suspension lamp</p> <p>IP 20 LED DIM 1x5W (E14) Dimmable</p> <p>Materials: blown glass, brass, steel</p>	1274010A	4.714,08	5.892,60	white diffuser, brushed brass body, black structure
	<p>nh S3 14 CLUSTER Neri&Hu Suspension lamp</p> <p>IP 20 LED DIM 3x5W (E14) Dimmable</p> <p>Materials: blown glass, brass, steel</p>	1276010A	11.427,78	14.284,73	white diffuser, brushed brass body, black structure

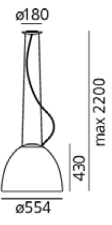
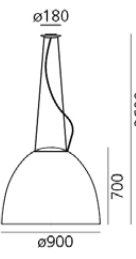

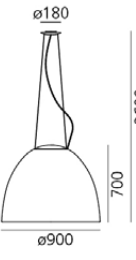
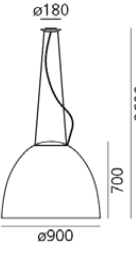
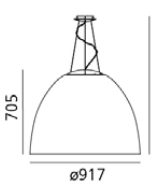
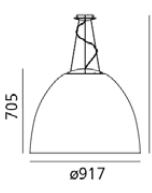
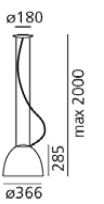

SUSPENSION LAMPS

	Code	Veil Pris NOK eks mva	Veil Pris NOK ink mva	
 <p>nh S1 22 Neri&Hu Suspension lamp</p> <p>IP 20 LED DIM 1x15W (E27)  Dimmable</p> <p>Materials: blown glass, brass, steel</p>	1273010A	4.863,81	6.079,76	white diffuser, brushed brass body, black structure
 <p>nh S2 22 Neri&Hu Suspension lamp</p> <p>IP 20 LED DIM 1x15W (E27)  Dimmable</p> <p>Materials: blown glass, brass, steel</p>	1275010A	4.974,90	6.218,63	white diffuser, brushed brass body, black structure
 <p>nh 14 SUSPENSION Neri&Hu Suspension lamp</p> <p>IP 20 LED DIM 1x5W (E14)  Dimmable</p> <p>Materials: blown glass, steel</p>	1280010A	4.202,10	5.252,63	white diffuser
 <p>nh 22 SUSPENSION Neri&Hu Suspension lamp</p> <p>IP 20 LED DIM 1x15W (E27)  Dimmable</p> <p>Materials: blown glass, steel</p>	1281010A	4.974,90	6.218,63	white diffuser
 <p>nh 35 SUSPENSION Neri&Hu Suspension lamp</p> <p>IP 20 LED DIM 1x20W (E27)  Dimmable</p> <p>Materials: blown glass, steel</p>	1283010A	5.796,00	7.245,00	white diffuser
 <p>nh S3 2 ARMS Neri&Hu Suspension lamp</p> <p>IP 20 LED DIM 2x15W (E27)  Dimmable</p> <p>Materials: blown glass, brass, steel</p>	1282010A	7.423,71	9.279,64	white diffuser


SUSPENSION LAMPS


 <p>nh S4 CIRCULAIRE Neri&Hu Suspension lamp</p> <p>IP 20 LED DIM 2x5W (E14) + LED 1x15W (E27) ⊗ Dimmable</p> <p>Materials: blown glass, brass, steel</p>	1278010A	16.243,29	20.304,11	white diffuser, brushed brass body, black structure
 <p>nh S5 ELLIPTIC Neri&Hu Suspension lamp</p> <p>IP 20 LED DIM 2x15W (E27) + LED 4x5W (E14) ⊗ Dimmable</p> <p>Materials: blown glass, brass, steel</p>	1279010A	25.260,90	31.576,13	white diffuser, brushed brass body, black structure
 <p>NUR Ernesto Gismondi Suspension lamp</p> <p>IP 20 LED DIM 1x21W (E27) ⊗ Dimmable</p> <p>Materials: aluminum, glass</p>	A240600	8.409,03	10.511,29	anthracite grey
	A240610	6.404,58	8.005,73	aluminium grey
	A249300	2.202,48	2.753,10	accessory: coloured filter
	A249400	1.081,92	1.352,40	accessory: anti-dazzle dome
 <p>NUR LED Ernesto Gismondi Suspension lamp</p> <p>IP 20 LED 2700K, 45W, 1882lm, CRI=90 Dimmable (Push & APP)</p> <p>Materials: aluminum, methacrylate, glass</p>	A243300APP	10.249,26	12.811,58	anthracite grey, Artemide APP
	A243310APP	10.249,26	12.811,58	aluminium grey, Artemide APP
 <p>NUR LED WHITE INTEGRALIS Ernesto Gismondi Suspension lamp</p> <p>IP 20 LED 5000K, 45W, 2423lm, CRI=90 Dimmable(APP)</p> <p>Materials: aluminum, methacrylate, glass</p>	A243300INOAPP	10.249,26	12.811,58	anthracite grey, Artemide APP
	A243310INOAPP	10.249,26	12.811,58	aluminium grey, Artemide APP
 <p>NUR GLOSS Ernesto Gismondi Suspension lamp</p> <p>IP 20 LED DIM 1x21W (E27) ⊗ Dimmable</p> <p>Materials: aluminum, methacrylate, glass</p>	A242100	7.375,41	9.219,26	gloss white
	A242110	9.230,13	11.537,66	gloss black

SUSPENSION LAMPS

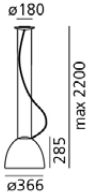
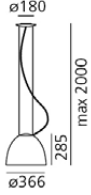

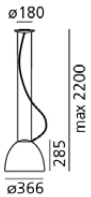

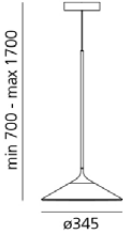
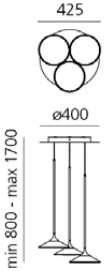
 <p>ø180 max 2200 430 ø554</p>	<p>NUR GLOSS LED Ernesto Gismondi Suspension lamp</p>	A243400APP	11.166,96	13.958,70	gloss white, Artemide APP
	<p>IP 20 LED 2700K, 45W, 2006lm, CRI=90 Dimmable (Push & APP) Materials: aluminum, methacrylate, glass</p>	A243410APP	13.123,11	16.403,89	gloss black, Artemide APP
 <p>ø180 max 2600 700 ø900</p>	<p>NUR 1618 Ernesto Gismondi Suspension lamp</p>	A242900	18.658,29	23.322,86	anthracite grey
	<p>IP 20 LED DIM 2x11W (R7s)  Dimmable Materials: aluminum, methacrylate, glass</p>	A242910	17.262,42	21.578,03	aluminium grey
 <p>ø180 max 2600 700 ø900</p>	<p>NUR 1618 LED Ernesto Gismondi Suspension lamp</p>	A243200	23.517,27	29.396,59	anthracite grey
	<p>IP 20 LED 3000K, 80W, 4308lm, CRI=90 Dimmable (Push) Materials: aluminum, methacrylate, glass</p>	A243210	22.237,32	27.796,65	aluminium grey
 <p>ø180 max 2600 700 ø900</p>	<p>NUR 1618 WHITE INTEGRALIS Ernesto Gismondi Suspension lamp</p>	A243200INO	23.517,27	29.396,59	anthracite grey
	<p>IP 20 LED 5000K, 80W, 4739lm, CRI=90 Dimmable (Push) Materials: aluminum, methacrylate, glass</p>	A243210INO	22.237,32	27.796,65	aluminium grey
 <p>ø180 max 2600 705 ø917</p>	<p>NUR 1618 ACOUSTIC Ernesto Gismondi Suspension lamp</p>	A243700	29.873,55	37.341,94	grey/inside white
	<p>IP 20 LED 3000K, 80W, 6151lm, CRI=90 Dimmable (Push) Materials: PET, methacrylate, glass</p>	A243720	29.873,55	37.341,94	white/inside white
 <p>ø180 max 2600 705 ø917</p>	<p>NUR 1618 ACOUSTIC WHITE INTEGRALIS Ernesto Gismondi Suspension lamp</p>	A243700INO	29.873,55	37.341,94	grey/inside white
	<p>IP 20 LED 5000K, 80W, 6733lm, CRI=90 Dimmable (Push) Materials: PET, methacrylate, glass</p>	A243720INO	29.873,55	37.341,94	white/inside white
 <p>ø180 max 2000 285 ø366</p>	<p>NUR MINI Ernesto Gismondi Suspension lamp</p>	A244000	6.452,88	8.066,10	anthracite grey
	<p>IP 20 LED DIM 1x11W (R7s)  Dimmable Materials: aluminum, glass</p>	A244010	5.684,91	7.106,14	aluminium grey
		A247900	1.791,93	2.239,91	accessory: coloured filter

LED Not replaceable integrated LED source

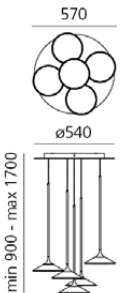


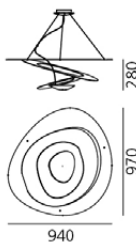

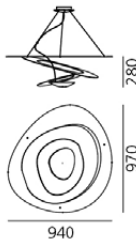


 Included source

 Excluded source



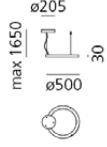


SUSPENSION LAMPS

		Code	Veil Pris NOK eks mva	Veil Pris NOK ink mva	
 <p>ø180 285 max 2200 ø366</p>	<p>NUR MINI LED Ernesto Gismondi Suspension lamp</p> <p>IP 20 LED 2700K, 30W, 1501lm, CRI=90 Dimmable (Push)</p> <p>Materials: aluminum, methacrylate, glass</p>	A246300	8.409,03	10.511,29	anthracite grey
		A246310	7.737,66	9.672,08	aluminium grey
 <p>ø180 285 max 2000 ø366</p>	<p>NUR MINI GLOSS Ernesto Gismondi Suspension lamp</p> <p>IP 20 LED DIM 1x21W (E27)  Dimmable</p> <p>Materials: aluminum, polycarbonate, glass</p>	A244900	6.143,76	7.679,70	gloss white
		A244910	7.013,16	8.766,45	gloss black
 <p>ø180 285 max 2200 ø366</p>	<p>NUR MINI GLOSS LED Ernesto Gismondi Suspension lamp</p> <p>IP 20 LED 2700K, 30W, 1287lm, CRI=90 Dimmable (Push)</p> <p>Materials: aluminum, methacrylate, glass</p>	A246400	7.887,39	9.859,24	gloss white
		A246410	8.819,58	11.024,48	gloss black
 <p>min 700 - max 1700 ø210</p>	<p>ORSA 21 Foster + Partners Suspension lamp</p> <p>IP 20 LED 3000K, 8,5W, 562lm, CRI=90</p> <p>Materials: methacrylate, aluminum, steel</p>	0351030A	4.974,90	6.218,63	transparent diffuser, black structure
 <p>min 700 - max 1700 ø345</p>	<p>ORSA 35 Foster + Partners Suspension lamp</p> <p>IP 20 LED 3000K, 20W, 1861lm, CRI=90 Dimmable (Push)</p> <p>Materials: methacrylate, aluminum, steel</p>	0352030A	6.964,86	8.706,08	transparent diffuser, black structure
 <p>425 ø400 min 800 - max 1700</p>	<p>ORSA CLUSTER 3 Foster + Partners Suspension lamp</p> <p>IP 20 LED 3000K, 22W, 1686lm, CRI=90 Dimmable (Push)</p> <p>Materials: methacrylate, aluminum, steel</p>	0353030A	14.040,81	17.551,01	transparent diffuser, black structure, chrome ceiling rose

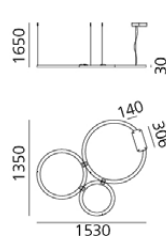

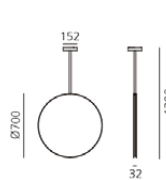
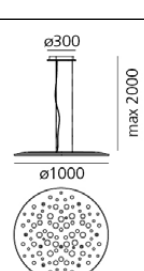
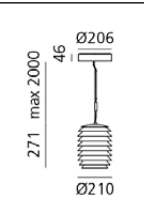
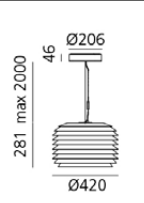
SUSPENSION LAMPS

	Code	Veil Pris NOK eks mva	Veil Pris NOK ink mva	
 <p>ORSA CLUSTER 5 Foster + Partners Suspension lamp</p> <p>IP 20 LED 3000K, 37W, 2810lm, CRI=90 Dimmable (Push)</p> <p>Materials: methacrylate, aluminum, steel</p>	0355030A	22.498,14	28.122,68	transparent diffuser, black structure, chrome ceiling rose
 <p>PIPE LED SUSPENSION Herzog & de Meuron Suspension lamp</p> <p>IP 20 LED 2700K, 27W, 1763lm, CRI=90 Dimmable (Push)</p> <p>Materials: polycarbonate, steel, silicone</p>	0672W10A	12.760,86	15.951,08	white translucent
 <p>PIPE LED SUSPENSION WHITE INTEGRALIS Herzog & de Meuron Suspension lamp</p> <p>IP 20 LED 5000K, 27W, 2143lm, CRI=90 Dimmable (Push)</p> <p>Materials: polycarbonate, steel, silicone</p>	0672010IN0A	12.760,86	15.951,08	white translucent
 <p>PIRCE SUSPENSION Giuseppe Maurizio Scutellà Suspension lamp</p> <p>IP 20 LED DIM 1x11W (R7s)  Dimmable</p> <p>Materials: aluminum</p>	1239010A	10.606,68	13.258,35	white
 <p>PIRCE LED SUSPENSION Giuseppe Maurizio Scutellà Suspension lamp</p> <p>IP 20 LED 2700K, 44W, 3097lm, CRI=90 Dimmable (Push)</p> <p>LED 3000K, 44W, 3313lm, CRI=90 Dimmable (Push)</p> <p>Materials: aluminum</p>	1254W10A	14.910,21	18.637,76	2700K, white
	1254110A	14.910,21	18.637,76	3000K, white
	1254120A	14.910,21	18.637,76	3000K, gold
 <p>PIRCE MINI SUSPENSION Giuseppe Maurizio Scutellà Suspension lamp</p> <p>IP 20 LED DIM 1x11W (R7s)  Dimmable</p> <p>Materials: aluminum</p>	1237010A	7.375,41	9.219,26	white

SUSPENSION LAMPS

		Code	Veil Pris NOK eks mva	Veil Pris NOK ink mva	
	<p>PIRCE MINI LED SUSPENSION Giuseppe Maurizio Scutellà Suspension lamp</p> <p>IP 20 LED 2700K, 44W, 3097lm, CRI=90 Dimmable (Push)</p> <p>LED 3000K, 44W, 3313lm, CRI=90 Dimmable (Push)</p> <p>Materials: aluminum</p>	1256W10A	11.529,21	14.411,51	2700K, white
		1256110A	11.529,21	14.411,51	3000K, white
		1256120A	11.529,21	14.411,51	3000K, gold
	<p>PIRCE MICRO LED SUSPENSION Giuseppe Maurizio Scutellà Suspension lamp</p> <p>IP 20 LED 2700K, 27W, 2573lm, CRI=90 Dimmable (Push)</p> <p>LED 3000K, 27W, 2753lm, CRI=90 Dimmable (Push)</p> <p>Materials: aluminum</p>	1249W10A	7.225,68	9.032,10	2700K, white
		1249010A	7.225,68	9.032,10	3000K, white
		1249020A	7.225,68	9.032,10	3000K, gold
	<p>RIPPLE 50 SUSPENSION BIG Suspension lamp</p> <p>IP 20 LED 3000K, 50W, 3089lm, CRI=90 Dimmable (Push/1-10/DALI)</p> <p>LED 3000K, 50W, 3089lm, CRI=90 Dimmable (Push & APP)</p> <p>Materials: aluminum, technopolymer</p>	2060010A	16.093,56	20.116,95	Ripple 50: white, Push/1-10/DALI
		2060010APP	16.755,27	20.944,09	Ripple 50: white, Push & Artemide APP
		2072120A	2.559,90	3.199,88	Ripple 50: diffuser with acoustic absorption h20cm
		2072020A	3.120,18	3.900,23	Ripple 50: diffuser with acoustic absorption h40cm
		2072220A	3.694,95	4.618,69	Ripple 50: diffuser with acoustic absorption h60cm
	<p>RIPPLE 70 SUSPENSION BIG Suspension lamp</p> <p>IP 20 LED 3000K, 50W, 3339lm, CRI=90 Dimmable (Push/1-10/DALI)</p> <p>LED 3000K, 50W, 3339lm, CRI=90 Dimmable (Push & APP)</p> <p>Materials: aluminum, technopolymer</p>	2061010A	18.494,07	23.117,59	Ripple 70: white, Push/1-10/DALI
		2061010APP	19.117,14	23.896,43	Ripple 70: white, Push & Artemide APP
		2073120A	3.023,58	3.779,48	Ripple 70: diffuser with acoustic absorption h20cm
		2073020A	3.844,68	4.805,85	Ripple 70: diffuser with acoustic absorption h40cm
		2073220A	4.516,05	5.645,06	Ripple 70: diffuser with acoustic absorption h60cm
	<p>RIPPLE 90 SUSPENSION BIG Suspension lamp</p> <p>IP 20 LED 3000K, 50W, 3378lm, CRI=90 Dimmable (Push/1-10/DALI)</p> <p>LED 3000K, 50W, 3378lm, CRI=90 Dimmable (Push & APP)</p> <p>Materials: aluminum, technopolymer</p>	2062010A	20.595,12	25.743,90	Ripple 90: white, Push/1-10/DALI
		2062010APP	21.266,49	26.583,11	Ripple 90: white, Push & Artemide APP
		2074120A	3.583,86	4.479,83	Ripple 90: diffuser with acoustic absorption h20cm
		2074020A	4.564,35	5.705,44	Ripple 90: diffuser with acoustic absorption h40cm
		2074220A	5.385,45	6.731,81	Ripple 90: diffuser with acoustic absorption h60cm



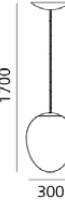


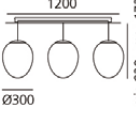
SUSPENSION LAMPS

 <p> RIPPLE CLUSTER 3 SUSPENSION BIG Suspension lamp</p> <p>IP 20 LED 3000K, 89W, 5806lm, CRI=90 Dimmable (Push/1-10/DALI)</p> <p>LED 3000K, 89W, 5806lm, CRI=90 Dimmable (Push & APP)</p> <p>Materials: aluminum, technopolymer</p>	2063010A	48.942,39	61.177,99	Ripple Cluster 3 elements: white, Push/1-10/DALI
	2063010APP	48.942,39	61.177,99	Ripple Cluster 3 elements: white, Push & Artemide APP
	2072120A	2.559,90	3.199,88	Ripple 50: diffuser with acoustic absorption h20cm
	2072020A	3.120,18	3.900,23	Ripple 50: diffuser with acoustic absorption h40cm
	2072220A	3.694,95	4.618,69	Ripple 50: diffuser with acoustic absorption h60cm
	2073120A	3.023,58	3.779,48	Ripple 70: diffuser with acoustic absorption h20cm
	2073020A	3.844,68	4.805,85	Ripple 70: diffuser with acoustic absorption h40cm
	2073220A	4.516,05	5.645,06	Ripple 70: diffuser with acoustic absorption h60cm
	2074120A	3.583,86	4.479,83	Ripple 90: diffuser with acoustic absorption h20cm
	2074020A	4.564,35	5.705,44	Ripple 90: diffuser with acoustic absorption h40cm
2074220A	5.385,45	6.731,81	Ripple 90: diffuser with acoustic absorption h60cm	
 <p> SCOPAS Neil Poulton Suspension lamp</p> <p>IP 20 LED 3000K, 80W, 2826lm, CRI=80 Dimmable (Push & APP)</p> <p>Materials: aluminum, methacrylate, ABS</p>	1529010APP	39.663,96	49.579,95	white/black, Artemide APP
 <p> SE ES SUSPENSION Carolina Gismondi dB, Daniele Moioli Suspension lamp</p> <p>IP 67 LED 3000K, 33W, 1200lm, CRI=90 Dimmable (Push & APP)</p> <p>Materials: steel, aluminum, optical silicone</p>	T070310	18.402,30	23.002,88	mirrored
				NEW
 <p> SILENT FIELD 2.0 DIRECT+INDIRECT LIGHT Carlotta de Bevilacqua, Laura Pessoni Suspension lamp</p> <p>IP 20 direct: LED 3000K, 35W, 2085lm, CRI=90 + indirect: LED 3000K, 40W, 3191lm, CRI=90 Dimmable (Push & APP)</p> <p>Materials: PET, technopolymer</p>	1013020APP	30.544,92	38.181,15	body white, Artemide APP
	1013040APP	30.544,92	38.181,15	body orange, Artemide APP
	1013030APP	30.544,92	38.181,15	body black, Artemide APP
 <p> SLICING SUSPENSION 21 BIG Suspension lamp</p> <p>IP 65 LED 3000K, 14W, 418lm, CRI=90</p> <p>Materials: aluminum, steel</p>	T250310	12.062,93	15.078,66	
 <p> SLICING SUSPENSION 42 BIG Suspension lamp</p> <p>IP 65 LED 3000K, 28W, 2149lm, CRI=90</p> <p>Materials: aluminum, steel</p>	T250410	18.535,13	23.168,91	

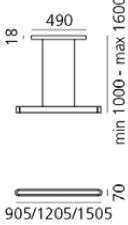
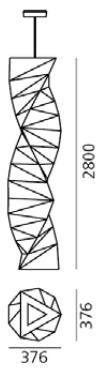
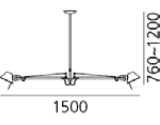

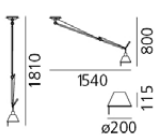

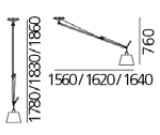


SUSPENSION LAMPS

	<p>SLICING SUSPENSION 63 BIG Suspension lamp IP 65 LED 3000K, 28W, 2149lm, CRI=90 Materials: aluminum, steel</p>	<p>T250510</p>	<p>22.640,63</p>	<p>28.300,78</p>	
	<p>SPECTRAL LIGHT Philippe Rahm Suspension lamp IP 20 indirect: LED 3000K, 40W, 3027lm, CRI=90 + direct: LED 20W (emotional light) Dimmable (Push) Materials: blown glass, methacrylate, aluminum, steel</p>	<p>0341010A</p>	<p>94.387,86</p>	<p>117.984,83</p>	<p>transparent diffuser, chrome structure</p>
	<p>STABLIGHT "A" Arik Levy Suspension lamp IP 20 LED DIM 1x6,8W 36° PAR (GU10) Dimmable Materials: blown glass, aluminum</p>	<p>DAL0027M14 DAL0027M80 DAL0027M12</p>	<p>3.844,68 3.844,68 3.844,68</p>	<p>4.805,85 4.805,85 4.805,85</p>	<p>acquamarine diffuser, black structure brown diffuser, black structure green/amber diffuser, black structure</p>
	<p>STABLIGHT "B" Arik Levy Suspension lamp IP 20 LED DIM 1x6,8W 36° PAR (GU10) Dimmable Materials: blown glass, aluminum</p>	<p>DAL0027N14 DAL0027N80 DAL0027N12</p>	<p>4.665,78 4.665,78 4.665,78</p>	<p>5.832,23 5.832,23 5.832,23</p>	<p>acquamarine diffuser, black structure brown diffuser, black structure green/amber diffuser, black structure</p>
	<p>STABLIGHT "C" Arik Levy Suspension lamp IP 20 LED DIM 1x6,8W 36° PAR (GU10) Dimmable Materials: blown glass, aluminum</p>	<p>DAL0027O14 DAL0027O80 DAL0027O12</p>	<p>4.926,60 4.926,60 4.926,60</p>	<p>6.158,25 6.158,25 6.158,25</p>	<p>acquamarine diffuser, black structure brown diffuser, black structure green/amber diffuser, black structure</p>
	<p>STABLIGHT Arik Levy Suspension lamp IP 20 LED DIM 3x6,8W 36° PAR (GU10) Dimmable Materials: blown glass, aluminum</p>	<p>DAL0027L14 DAL0027L80 DAL0027L12 DAL0027L90</p>	<p>12.712,56 12.712,56 12.712,56 12.712,56</p>	<p>15.890,70 15.890,70 15.890,70 15.890,70</p>	<p>acquamarine diffuser, black structure brown diffuser, black structure green/amber diffuser, black structure 3 colours: "A" brown "B" green/amber "C" acquamarine</p>

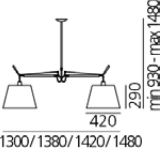





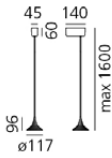
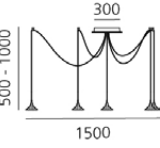
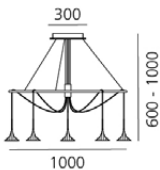
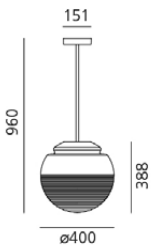

SUSPENSION LAMPS

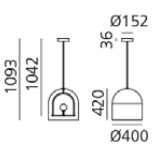
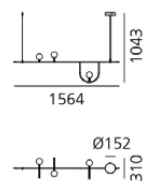
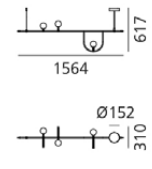
 <p>STELLAR NEBULA 16 BIG Suspension lamp</p> <p>IP 20 LED 3000K, 9W, 300lm, CRI=90 Dimmable (Push)</p> <p>Materials: blown glass with PVD treatment, aluminum</p>	0152000A	8.935,50	11.169,38	blown glass with dichroic treatment PVD	NEW
 <p>STELLAR NEBULA 22 BIG Suspension lamp</p> <p>IP 20 LED 3000K, 11W, 486lm, CRI=90 Dimmable (Push)</p> <p>Materials: blown glass with PVD treatment, aluminum</p>	0152010A	10.249,26	12.811,58	blown glass with dichroic treatment PVD	
 <p>STELLAR NEBULA 30 BIG Suspension lamp</p> <p>IP 20 LED 3000K, 20W, 1890lm CRI=90 Dimmable (Push)</p> <p>Materials: blown glass with PVD treatment, aluminum</p>	0152020A	14.963,34	18.704,18	blown glass with dichroic treatment PVD	
 <p>STELLAR NEBULA 40 BIG Suspension lamp</p> <p>IP 20 LED 3000K, 28W, 2536lm, CRI=90 Dimmable (Push)</p> <p>Materials: blown glass with PVD treatment, aluminum</p>	0152030A	19.266,87	24.083,59	blown glass with dichroic treatment PVD	
 <p>STELLAR NEBULA CLUSTER CIRCULAR BIG Suspension lamp</p> <p>IP20 LED 3000K, 55W, 3331lm, CRI=90 Dimmable (Push)</p> <p>Materials: blown glass with PVD treatment, aluminum</p>	0152420APP	42.943,53	53.679,41	transparent diffuser with dichroic PVD treatment	
 <p>STELLAR NEBULA CLUSTER LINEAR BIG Suspension lamp</p> <p>IP20 LED 3000K, 55W, 3331lm, CRI=90 Dimmable (Push)</p> <p>Materials: blown glass with PVD treatment, aluminum</p>	0152520APP	42.943,53	53.679,41	transparent diffuser with dichroic PVD treatment	

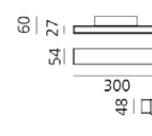
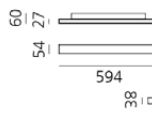
SUSPENSION LAMPS

		Code	Veil Pris NOK eks mva	Veil Pris NOK ink mva	
 <p>TALO (90, 120, 150) LED SUSPENSION Neil Poulton Suspension lamp</p> <p>IP 20 Talo 90: LED 3000K, 32W, 3840lm, CRI=80 Not dimmable and dimmable (Push)</p> <p>Talo 120: LED 3000K, 51W, 6020lm, CRI=80 Not dimmable and dimmable (Push)</p> <p>Talo 150: LED 3000K, 60W, 7206lm, CRI=80 Not dimmable and dimmable (Push)</p> <p>Materials: aluminum, methacrylate, polycarbonate</p>	1921010A	8.297,94	10.372,43	TALO 90 LED: not dimmable, white	
	1921020A	8.297,94	10.372,43	TALO 90 LED: not dimmable, silver	
	1921080A	8.297,94	10.372,43	TALO 90 LED: not dimmable, black matt	
	1922010A	9.838,71	12.298,39	TALO 90 LED: dimmable, white	
	1922020A	9.838,71	12.298,39	TALO 90 LED: dimmable, silver	
	1922080A	9.838,71	12.298,39	TALO 90 LED: dimmable, black matt	
	1923010A	9.790,41	12.238,01	TALO 120 LED: not dimmable, white	
	1923020A	9.790,41	12.238,01	TALO 120 LED: not dimmable, silver	
	1923080A	9.790,41	12.238,01	TALO 120 LED: not dimmable, black matt	
	1924010A	11.529,21	14.411,51	TALO 120 LED: dimmable, white	
	1924020A	11.529,21	14.411,51	TALO 120 LED: dimmable, silver	
	1924080A	11.529,21	14.411,51	TALO 120 LED: dimmable, black matt	
	1925010A	11.070,36	13.837,95	TALO 150 LED: not dimmable, white	
	1925020A	11.070,36	13.837,95	TALO 150 LED: not dimmable, silver	
	1925080A	11.070,36	13.837,95	TALO 150 LED: not dimmable, black matt	
	1926010A	12.712,56	15.890,70	TALO 150 LED: dimmable, white	
1926020A	12.712,56	15.890,70	TALO 150 LED: dimmable, silver		
1926080A	12.712,56	15.890,70	TALO 150 LED: dimmable, black matt		
 <p>TATSUNO-OTOSHIGO Issey Miyake + Reality Lab IN-EI suspension lamp</p> <p>IP 20 LED 3000K, 28W, 2119lm, CRI=90 Dimmable (Push)</p> <p>Materials: recycled PET, methacrylate, aluminum</p>	1696010A	15.320,76	19.150,95	white	
 <p>TOLOMEO DUE BRACCI SUSPENSION aluminium Michele De Lucchi, Giancarlo Fassina Suspension lamp</p> <p>IP 20 LED 2x10,5W (E27) </p> <p>Materials: aluminum</p>	A036400	6.254,85	7.818,56	aluminium	
 <p>TOLOMEO DECENTRATA SUSPENSION aluminium diffuser Michele De Lucchi, Giancarlo Fassina Suspension lamp</p> <p>IP 20 LED 1x10,5W (E27) </p> <p>Dimmable</p> <p>Materials: aluminum</p>	0629000A	5.076,33	6.345,41	aluminium structure	
	0371050A	1.130,22	1.412,78	diffuser aluminium Complete lamp consists of 2 items.	
 <p>TOLOMEO DECENTRATA SUSPENSION parchment paper/ silk diffuser Michele De Lucchi, Giancarlo Fassina Suspension lamp</p> <p>IP 20 ø 240: LED DIM 1x17W (E27) </p> <p>ø 320, 360: LED DIM 1x21W (E27) </p> <p>Dimmable</p> <p>Materials: parchment paper or silk satin, aluminum</p>	0629000A	5.076,33	6.345,41	aluminium structure	
	0372050A	1.381,38	1.726,73	parchment paper diffuser ø 240 mm	
	0780010A	1.642,20	2.052,75	parchment paper diffuser ø 320 mm	
	0780020A	1.743,63	2.179,54	parchment paper diffuser ø 360 mm	
	0781050A	1.429,68	1.787,10	silk diffuser ø 240 mm	
	0781010A	1.791,93	2.239,91	silk diffuser ø 320 mm	
	0781020A	2.250,78	2.813,48	silk diffuser ø 360 mm Complete lamp consists of 2 items.	

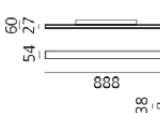
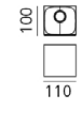
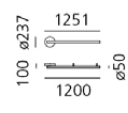
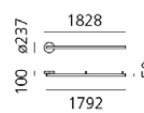

SUSPENSION LAMPS

 <p>TOLOMEO BASCULANTE SUSPENSION 2 ARMS Michele De Lucchi, Giancarlo Fassina Suspension lamp</p> <p>IP 20 ø 240: LED DIM 2x17W (E27)  ø 320: LED DIM 2x21W (E27)  360, 420: LED DIM 2x21W (E27)  Dimmable</p> <p>Materials: parchment paper or silk satin, aluminum</p>	0630010A	6.404,58	8.005,73	aluminium structure	
	0372050A	1.381,38	1.726,73	parchment paper diffuser ø 240 mm	
	0780010A	1.642,20	2.052,75	parchment paper diffuser ø 320 mm	
	0780020A	1.743,63	2.179,54	parchment paper diffuser ø 360 mm	
	0780030A	1.840,23	2.300,29	parchment paper diffuser ø 420 mm	
	0781050A	1.429,68	1.787,10	silk diffuser ø 240 mm	
	0781010A	1.791,93	2.239,91	silk diffuser ø 320 mm	
	0781020A	2.250,78	2.813,48	silk diffuser ø 360 mm	
	0781030A	2.415,00	3.018,75	silk diffuser ø 420 mm	
				Complete lamp consists of 3 items.	
 <p>TOLOMEO MEGA SUSPENSION Michele De Lucchi, Giancarlo Fassina Suspension lamp</p> <p>IP 20 LED DIM 1x21W (E27)  Dimmable</p> <p>Materials: textile fabric or silk satin or parchment paper, aluminum</p>	0782010A	3.023,58	3.779,48	aluminium structure	
	0782030A	4.105,50	5.131,88	structure black	
	0780030A	1.840,23	2.300,29	parchment paper diffuser ø 420 mm	
	0781030A	2.415,00	3.018,75	silk diffuser ø 420 mm	
	0780060A	2.149,35	2.686,69	parchment paper diffuser ø 520 mm	
	0781060A	2.463,30	3.079,13	satin diffuser ø 520 mm	
	0772030A	2.559,90	3.199,88	black satin diffuser ø 420 mm	
	0772040A	2.762,76	3.453,45	black satin diffuser ø 520 mm	
			Complete lamp consists of 2 items.		
 <p>UNTERLINDEN Herzog & de Meuron Suspension lamp</p> <p>IP 20 LED 2700K, 7,5W, 339lm, CRI=90 LED 3000K, 7,5W, 349lm, CRI=90</p> <p>Materials: brass or aluminum</p>	1936W10A	4.863,81	6.079,76	2700K, antique brass	
	1936010A	4.863,81	6.079,76	3000K, antique brass	
	1935W10A	4.516,05	5.645,06	2700K, antique aluminium	
	1935010A	4.516,05	5.645,06	3000K, antique aluminium	
 <p>UNTELINDEN CHANDELIER FREE Herzog & de Meuron Suspension lamp</p> <p>IP20 LED 2700K, 34W, 1760lm, CRI=90 LED 3000K, 34W, 1838lm, CRI=90</p> <p>Materials: aluminum or brass, steel, technopolymer</p>	1093W10A	22.362,90	27.953,63	2700K, antique aluminum	
	1093010A	22.362,90	27.953,63	3000K, antique aluminum	
	1094W10A	26.492,55	33.115,69	2700K, antique brass	
	1094010A	26.492,55	33.115,69	3000K, antique brass	NEW
 <p>UNTELINDEN CHANDELIER RING Herzog & de Meuron Suspension lamp</p> <p>IP20 LED 2700K, 34W, 1760lm, CRI=90 LED 3000K, 34W, 1838lm, CRI=90</p> <p>Materials: aluminum or brass, steel, technopolymer</p>	1091W10A	28.014,00	35.017,50	2700K, antique aluminum	
	1091010A	28.014,00	35.017,50	3000K, antique aluminum	
	1092W10A	31.986,68	39.983,34	2700K, antique brass	
	1092010A	31.986,68	39.983,34	3000K, antique brass	NEW
 <p>VITRUVIO SUSPENSION Atelier Oi Suspension lamp</p> <p>IP 20 LED DIM 1x21W (E27)  Dimmable</p> <p>Materials: aluminum, blown glass, steel</p>	1263010A	12.451,74	15.564,68	brass structure, transparent glass diffuser	
	1263030A	12.451,74	15.564,68	black structure, smoked glass diffuser	

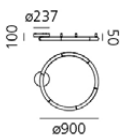
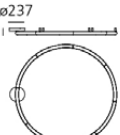
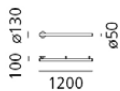
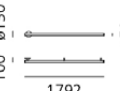
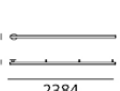
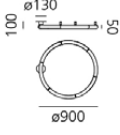
SUSPENSION LAMPS				
 <p>YANZI SUSPENSION Neri&Hu Suspension lamp IP 20 LED 3000K, 10W, 640lm, CRI=90 Dimmable (Push) Materials: steel, blown glass, zamac</p>	1103010A	15.373,89	19.217,36	ext. diff. transparent, int. diff. white, brushed brass body, black structure
 <p>YANZI 1 SUSPENSION Neri&Hu Suspension lamp IP 20 LED 3000K, 26W, 2122lm, CRI=90 Dimmable (Push) Materials: steel, aluminum, blown glass, zamac</p>	1104010A	17.016,09	21.270,11	white diffuser, brushed brass body, black structure
 <p>YANZI SC1 SUSPENSION Neri&Hu Suspension lamp IP 20 LED 3000K, 26W, 2122lm, CRI=90 Dimmable (Push) Materials: steel, aluminum, blown glass, zamac</p>	1106010A	16.653,84	20.817,30	white diffuser, brushed brass body, black structure

WALL OR CEILING LAMPS				
 <p>A.24 WALL 300 Carlotta de Bevilacqua Wall lamp IP 20 LED 2700K, 15W, 1300lm, CRI=90 Dimmable (Push - DALI) LED 3000K, 15W, 1380lm, CRI=90 Dimmable (Push - DALI) Materials: aluminium, methacrylate</p>	BK01001	3.610,43	4.513,03	2700K, white
	BK01004	3.610,43	4.513,03	2700K, black
	BK01015	3.851,93	4.814,91	2700K, silver
	BK01018	3.851,93	4.814,91	2700K, brass
	BK01020	3.851,93	4.814,91	2700K, bronze
	BK02001	3.610,43	4.513,03	3000K, white
	BK02004	3.610,43	4.513,03	3000K, black
	BK02015	3.851,93	4.814,91	3000K, silver
	BK02018	3.851,93	4.814,91	3000K, brass
	BK02020	3.851,93	4.814,91	3000K, bronze
NEW				
 <p>A.24 WALL 600 Carlotta de Bevilacqua Wall lamp IP 20 LED 2700K, 30W, 2601lm, CRI=90 Dimmable (Push - DALI) LED 3000K, 30W, 2759lm, CRI=90 Dimmable (Push - DALI) Materials: aluminium, methacrylate</p>	BK11001	5.095,65	6.369,56	2700K, white
	BK11004	5.095,65	6.369,56	2700K, black
	BK11015	5.530,35	6.912,94	2700K, silver
	BK11018	5.530,35	6.912,94	2700K, brass
	BK11020	5.530,35	6.912,94	2700K, bronze
	BK12001	5.095,65	6.369,56	3000K, white
	BK12004	5.095,65	6.369,56	3000K, black
	BK12015	5.530,35	6.912,94	3000K, silver
	BK12018	5.530,35	6.912,94	3000K, brass
	BK12020	5.530,35	6.912,94	3000K, bronze
NEW				

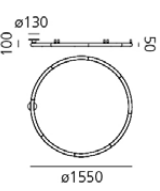
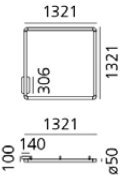
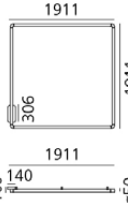
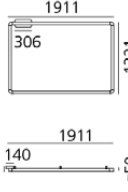
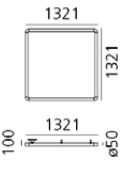
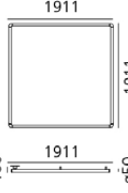
WALL OR CEILING LAMPS

 <p>A.24 WALL 900 Carlotta de Bevilacqua Wall lamp</p> <p>IP 20 LED 2700K, 45W, 3901lm, CRI=90 Dimmable (Push - DALI)</p> <p>LED 3000K, 45W, 4139lm, CRI=90 Dimmable (Push - DALI)</p> <p>Materials: aluminium, methacrylate</p>	BK21001	6.653,33	8.316,66	2700K, white
	BK21004	6.653,33	8.316,66	2700K, black
	BK21015	7.027,65	8.784,56	2700K, silver
	BK21018	7.027,65	8.784,56	2700K, brass
	BK21020	7.027,65	8.784,56	2700K, bronze
	BK22001	6.653,33	8.316,66	3000K, white
	BK22004	6.653,33	8.316,66	3000K, black
	BK22015	7.027,65	8.784,56	3000K, silver
	BK22018	7.027,65	8.784,56	3000K, brass
	BK22020	7.027,65	8.784,56	3000K, bronze
				NEW
 <p>AEDE WALL Pio & Tito Toso Wall lamp</p> <p>IP 20 LED 2700K, 20W, 1281lm, CRI=90 Dimmable (Push)</p> <p>Materials: aluminum</p>	0041020A	2.922,15	3.652,69	glossy white
 <p>ALPHABET OF LIGHT LINEAR 120 WALL/CEILING BIG Wall or ceiling lamp</p> <p>IP 20 LED 3000K, 35W, 3484lm, CRI=80 Dimmable (Push/DALI)</p> <p>LED 3000K, 35W, 3484lm, CRI=80 Dimmable (Push & APP)</p> <p>Materials: methacrylate, aluminum</p>	1304000A	9.988,44	12.485,55	white, Push/DALI
	1304000APP	9.988,44	12.485,55	white, Push & Artemide APP
 <p>ALPHABET OF LIGHT LINEAR 180 WALL/CEILING BIG Wall or ceiling lamp</p> <p>IP 20 LED 3000K, 50W, 5226lm, CRI=80 Dimmable (Push/DALI)</p> <p>LED 3000K, 50W, 5226lm, CRI=80 Dimmable (Push & APP)</p> <p>Materials: methacrylate, aluminum</p>	1305000A	11.790,03	14.737,54	white, Push/DALI
	1305000APP	11.790,03	14.737,54	white, Push & Artemide APP
 <p>ALPHABET OF LIGHT LINEAR 240 WALL/CEILING BIG Wall or ceiling lamp</p> <p>IP 20 LED 3000K, 63W, 6968lm, CRI=80 Dimmable (Push/DALI)</p> <p>LED 3000K, 63W, 6968lm, CRI=80 Dimmable (Push & APP)</p> <p>Materials: methacrylate, aluminum</p>	1308000A	13.630,26	17.037,83	white, Push/DALI
	1308000APP	13.630,26	17.037,83	white, Push & Artemide APP

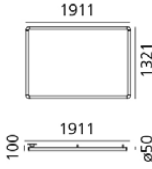
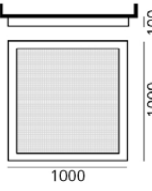
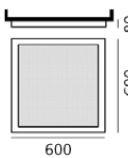
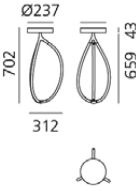
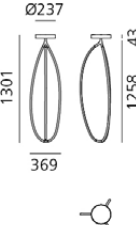
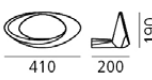
WALL OR CEILING LAMPS

 <p>ALPHABET OF LIGHT CIRCULAR Ø90 WALL/CEILING BIG Wall or ceiling lamp</p> <p>IP 20 LED 3000K, 55W, 6041lm, CRI=80 Dimmable (Push/DALI)</p> <p>LED 3000K, 55W, 6041lm, CRI=80 Dimmable (Push & APP)</p> <p>Materials: methacrylate, aluminum</p>	1306000A	18.247,74	22.809,68	white, Push/DALI
	1306000APP	18.247,74	22.809,68	white, Push & Artemide APP
 <p>ALPHABET OF LIGHT CIRCULAR Ø155 WALL/CEILING BIG Wall or ceiling lamp</p> <p>IP 20 LED 3000K, 91W, 10739lm, CRI=80 Dimmable (Push/DALI)</p> <p>LED 3000K, 91W, 10739lm, CRI=80 Dimmable (Push & APP)</p> <p>Materials: methacrylate, aluminum</p>	1307000A	28.545,30	35.681,63	white, Push/DALI
	1307000APP	28.545,30	35.681,63	white, Push & Artemide APP
 <p>ALPHABET OF LIGHT LINEAR 120 SEMI-RECESSED BIG Semi-recessed fixture</p> <p>IP 20 LED 3000K, 29W, 3484lm, CRI=80 Dimmable (Push/DALI) con driver APP (Push & APP)</p> <p>Materials: methacrylate, aluminum</p>	1425000A	8.558,76	10.698,45	white
	DV1035	1.130,22	1.412,78	driver CC 110-240V 350-1200mA PUSH/DALI/1-10
	DV1035APP	1.540,77	1.925,96	driver CC 110-240V 350-1200mA APP EXT
 <p>ALPHABET OF LIGHT LINEAR 180 SEMI-RECESSED BIG Semi-recessed fixture</p> <p>IP 20 LED 3000K, 44W, 5226lm, CRI=80 Dimmable (Push/DALI) with driver APP (Push & APP)</p> <p>Materials: methacrylate, aluminum</p>	1426000A	10.249,26	12.811,58	white
	DV1035	1.130,22	1.412,78	driver CC 110-240V 350-1200mA PUSH/DALI/1-10
	DV1035APP	1.540,77	1.925,96	driver CC 110-240V 350-1200mA APP EXT
 <p>ALPHABET OF LIGHT LINEAR 240 SEMI-RECESSED BIG Semi-recessed fixture</p> <p>IP 20 LED 3000K, 58W, 6968lm, CRI=80 Dimmable (Push/DALI) with driver APP (Push & APP)</p> <p>Materials: methacrylate, aluminum</p>	1427000A	12.089,49	15.111,86	white
	DV1034	1.183,35	1.479,19	driver CC 110-240V 1050-2100mA PUSH/DALI/1-10
	DV1034APP	1.540,77	1.925,96	driver CC 110-240V 1050-2100mA APP EXT
 <p>ALPHABET OF LIGHT CIRCULAR Ø90 SEMI-RECESSED BIG Semi-recessed fixture</p> <p>IP 20 LED 3000K, 50W, 6040lm, CRI=80 Dimmable (Push/DALI) with driver APP (Push & APP)</p> <p>Materials: methacrylate, aluminum</p>	1428000A	16.702,14	20.877,68	white
	DV1034	1.183,35	1.479,19	driver CC 110-240V 1050-2100mA PUSH/DALI/1-10
	DV1034APP	1.540,77	1.925,96	driver CC 110-240V 1050-2100mA APP EXT

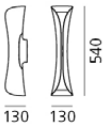



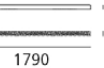

WALL OR CEILING LAMPS

 <p>ALPHABET OF LIGHT CIRCULAR Ø155 SEMI-RECESSED BIG Semi-recessed fixture</p> <p>IP 20 LED 3000K, 86W, 10740lm, CRI=80 Dimmable (Push/DALI) with driver APP (Push & APP)</p> <p>Materials: methacrylate, aluminum</p>	1429000A	25.671,45	32.089,31	white
	DV1036	2.415,00	3.018,75	driver CC 110-240V 2x350-1200mA PUSH/DALI/1-10
	DV1036APP	2.873,85	3.592,31	driver CC 110-240V 2x1200mA APP EXT
				The APP driver excluded the operation by means of DALI and vice versa
 <p>ALPHABET OF LIGHT SQUARE 120 WALL/CEILING BIG Wall or ceiling lamp</p> <p>IP 20 LED 3000K, 100W, 8195lm, CRI=80 Dimmable (Push/DALI)</p> <p>LED 3000K, 100W, 8195lm, CRI=80 Dimmable (APP)</p> <p>Materials: methacrylate, aluminum</p>	1430210A	39.562,53	49.453,16	white, Push/DALI
	1430210APP	39.562,53	49.453,16	white, Artemide APP
 <p>ALPHABET OF LIGHT SQUARE 180 WALL/CEILING BIG Wall or ceiling lamp</p> <p>IP 20 LED 3000K, 145W, 12104lm, CRI=80 Dimmable (Push/DALI)</p> <p>LED 3000K, 145W, 12104lm, CRI=80 Dimmable (APP)</p> <p>Materials: methacrylate, aluminum</p>	1430220A	49.092,12	61.365,15	white, Push/DALI
	1430220APP	49.092,12	61.365,15	white, Artemide APP
 <p>ALPHABET OF LIGHT RECTANGULAR WALL-CEILING BIG Wall or ceiling lamp</p> <p>IP 20 LED 3000K, 120W, 10150lm, CRI=80 Dimmable (Push/DALI)</p> <p>LED 3000K, 125W, 10150lm, CRI=80 Dimmable (APP)</p> <p>Materials: methacrylate, aluminum</p>	1430230A	44.276,61	55.345,76	white, Push/DALI
	1430230APP	44.276,61	55.345,76	white, Artemide APP
 <p>ALPHABET OF LIGHT SQUARE 120 SEMI-RECESSED BIG Wall or ceiling lamp</p> <p>IP 20 LED 3000K, 90W, 8195lm, CRI=80 Dimmable (Push/DALI)</p> <p>Materials: methacrylate, aluminum</p>	1430110A	40.731,39	50.914,24	white, Push/DALI
	2277010A	4.612,65	5.765,81	Dali / Push remote power unit box
	2277010APP	6.042,33	7.552,91	APP remote power unit box (220-240VAC)
				electronic power supply included II The APP driver excluded the operation by means of DALI and vice versa
 <p>ALPHABET OF LIGHT SQUARE 180 SEMI-RECESSED BIG Semi-recessed fixture</p> <p>IP 20 LED 3000K, 138W, 12104lm, CRI=80 Dimmable (Push/DALI)</p> <p>Materials: methacrylate, aluminum</p>	1430120A	49.092,12	61.365,15	white, Push/DALI
	2271010A	5.994,03	7.492,54	Dali / Push remote power unit box
	2271010APP	7.273,98	9.092,48	APP remote power unit box (220-240VAC)
				electronic power supply included II The APP driver excluded the operation by means of DALI and vice versa

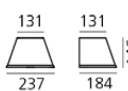



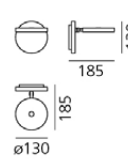
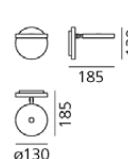
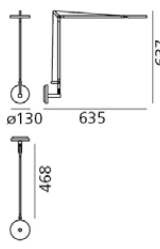
WALL OR CEILING LAMPS

 <p>ALPHABET OF LIGHT RECTANGULAR SEMI-RECESSED BIG Semi-recessed fixture</p> <p>IP 20 LED 3000K, 114W, 10150lm, CRI=80 Dimmable (Push/DALI)</p> <p>Materials: methacrylate, aluminum</p>	1430130A	45.556,56	56.945,70	white, Push/DALI
	2277010A	4.612,65	5.765,81	Dali / Push remote power unit box
	2277010APP	6.042,33	7.552,91	APP remote power unit box (220-240VAC)
 <p>ALTROVE LED WALL/CEILING Carlotta de Bevilacqua Wall or ceiling lamp</p> <p>IP 20 LED 3000K, 82W, 3248lm, CRI=90 + LED 56W, 508lm (RGB) Dimmable (Push & APP)</p> <p>Materials: methacrylate, aluminum</p>	1352150APP	40.895,61	51.119,51	Push & Artemide APP
	electronic power supply included II The APP driver excluded the operation by means of DALI and vice versa			
 <p>ALTROVE 600 LED WALL/CEILING Carlotta de Bevilacqua Wall or ceiling lamp</p> <p>IP 20 LED 3000K, 76W, 3822lm, CRI=90 Dimmable (Push)</p> <p>Materials: methacrylate, aluminum</p>	1538110A	16.914,66	21.143,33	
 <p>ARRIVAL 70 CEILING Ludovica+Roberto Palomba Ceiling lamp</p> <p>IP 20 LED Strip LED 3000K, 26W, 809lm, CRI=90 Dimmable (Push & APP)</p> <p>Materials: aluminum, silicone, steel</p>	1554010APP	12.451,74	15.564,68	gold, Push & Artemide APP
	1554030APP	12.451,74	15.564,68	black matt, Push & Artemide APP
 <p>ARRIVAL 130 CEILING Ludovica+Roberto Palomba Ceiling lamp</p> <p>IP 20 LED Strip LED 3000K, 48W, 1618lm, CRI=90 Dimmable (Push & APP)</p> <p>Materials: aluminum, silicone, steel</p>	1555010APP	16.194,99	20.243,74	gold, Push & Artemide APP
	1555030APP	16.194,99	20.243,74	black matt, Push & Artemide APP
 <p>CABILDO LED WALL Eric Solé Wall lamp</p> <p>IP 20 LED 2700K, 28W, 1996lm, CRI=90 Dimmable (Push)</p> <p>LED 3000K, 28W, 2137lm, CRI=90 Dimmable (Push)</p> <p>Materials: aluminum</p>	1181W10A	5.433,75	6.792,19	2700K, white
	1181010A	5.433,75	6.792,19	3000K, white


WALL OR CEILING LAMPS


	<p>CADMO LED WALL Karim Rashid Wall lamp</p> <p>IP 20 LED DIM 2x10W (GU10)  Dimmable</p> <p>Materials: ABS</p>	1373010A	5.023,20	6.279,00	black/white inside
		1373020A	4.516,05	5.645,06	white
	<p>CALIPSO WALL/CEILING Neil Poulton Wall or ceiling lamp</p> <p>IP 20 LED 2700K, 50W, 4038lm, CRI=90 Dimmable (Push & APP)</p> <p>LED 3000K, 50W, 4099lm, CRI=90 Dimmable (Push & APP)</p> <p>Materials: technopolymer</p>	0210W10APP	11.427,78	14.284,73	2700K white, Push & Artemide APP
		0210010APP	11.427,78	14.284,73	3000K white, Push & Artemide APP
	<p>CALIPSO LINEAR 120 STAND-ALONE CEILING Neil Poulton Ceiling lamp</p> <p>IP 20 LED 3000K, 43W, 2985lm, CRI=90 Dimmable (APP)</p> <p>Materials: technopolymer</p>	0220010APP	11.166,96	13.958,70	white, Artemide APP
	<p>CALIPSO LINEAR 180 STAND-ALONE CEILING Neil Poulton Ceiling lamp</p> <p>IP 20 LED 3000K, 63W, 4477lm, CRI=90 Dimmable (APP)</p> <p>Materials: technopolymer</p>	0221010APP	14.765,31	18.456,64	white, Artemide APP
	<p>CALIPSO LINEAR SYSTEM CEILING Neil Poulton Ceiling system</p> <p>IP 20 Module 588mm: LED 3000K, 22W, 1492lm, CRI=90 Dimmable (Push/DALI)</p> <p>Module 1210mm: LED 3000K, 43W, 2985lm, CRI=90 Dimmable (Push/DALI)</p> <p>Module APP 1210mm: LED 3000K, 43W, 2985lm, CRI=90 Dimmable (APP)</p> <p>Module 1785mm: LED 3000K, 63W, 4477lm, CRI=90 Dimmable (Push/DALI)</p> <p>Module APP 1785mm: LED 3000K, 63W, 4477lm, CRI=90 Dimmable (APP)</p> <p>Materials: technopolymer</p>	2010010A	7.075,95	8.844,94	module 588mm, white, Push/DALI
		2011010A	10.099,53	12.624,41	module 1210mm, white, Push/DALI
		2011010APP	11.427,78	14.284,73	module 1210mm, white, Artemide APP
		2012010A	13.731,69	17.164,61	module 1785mm, white, Push/DALI
		2012010APP	15.011,64	18.764,55	module 1785mm, white, Artemide APP
		2026010A	772,80	966,00	end cap kit (2pcs)
		2027010A	772,80	966,00	joint 90° kit (left+right) to connect 90° modules
		2025010A	198,03	247,54	intermediate joint kit to connect in line modules
					The system, in APP operation, consists of a single APP Master module; subsequent modules, completing the system, must be DALI.

WALL OR CEILING LAMPS

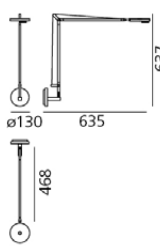







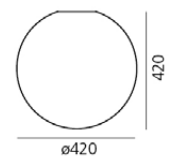

		Code	Veil Pris NOK eks mva	Veil Pris NOK ink mva	
	<p>CHOOSE WALL IP 23 Matteo Thun Wall lamp</p> <p>IP 23 LED DIM 1x6W (E14)  Dimmable</p> <p>Materials: polycarbonate, parchment paper</p>	1142020A	1.540,77	1.925,96	parchment paper diffuser, without switch
		1142110A	1.540,77	1.925,96	white diffuser, without switch
	<p>DECOMPOSE' LIGHT CEILING Atelier Oi Ceiling system</p> <p>IP 20 LED 1x13W (E27)  Materials: aluminum</p>	DOI4600B02	3.994,41	4.993,01	gold
		DOI4600B03	3.994,41	4.993,01	orange
		DOI4600B16	3.994,41	4.993,01	red
		DOI4600B80	3.994,41	4.993,01	smoked
	<p>DEMETRA FARETTO with switch Naoto Fukasawa Wall lamp</p> <p>IP 20 LED 2700K, 9W, 360lm, CRI=90 Dimmer</p> <p>LED 3000K, 9W, 385lm, CRI=90 Dimmer</p> <p>Materials: aluminum</p>	1730W10A	3.173,31	3.966,64	2700K, with switch, anthracite grey
		1730010A	3.173,31	3.966,64	3000K, with switch, anthracite grey
		1730W20A	3.173,31	3.966,64	2700K, with switch, white
		1730020A	3.173,31	3.966,64	3000K, with switch, white
		1730W50A	3.173,31	3.966,64	2700K, with switch, opaque black
		1730050A	3.173,31	3.966,64	3000K, with switch, opaque black
	<p>DEMETRA FARETTO without switch Naoto Fukasawa Wall lamp</p> <p>IP 20 LED 2700K, 8W, 360lm, CRI=90</p> <p>LED 3000K, 8W, 385m, CRI=90</p> <p>Materials: aluminum</p>	1731W10A	2.922,15	3.652,69	2700K, without switch, anthracite grey
		1731010A	2.922,15	3.652,69	3000K, without switch, anthracite grey
		1731W20A	2.922,15	3.652,69	2700K, without switch, white
		1731020A	2.922,15	3.652,69	3000K, without switch, white
		1731W50A	2.922,15	3.652,69	2700K, without switch, opaque black
		1731050A	2.922,15	3.652,69	3000K, without switch, opaque black
	<p>DEMETRA WALL Naoto Fukasawa Wall lamp</p> <p>IP 20 LED 2700K, 8W, 360lm, CRI=90 Dimmer</p> <p>LED 3000K, 8W, 385lm, CRI=90 Dimmer</p> <p>Materials: aluminum, technopolymer, steel</p>	1734W10A	3.844,68	4.805,85	body lamp 2700K anthracite grey
		1734010A	3.844,68	4.805,85	body lamp 3000K anthracite grey
		1734W20A	3.844,68	4.805,85	body lamp 2700K white
		1734020A	3.844,68	4.805,85	body lamp 3000K white
		1734W50A	3.844,68	4.805,85	body lamp 2700K opaque black
		1734050A	3.844,68	4.805,85	body lamp 3000K opaque black
		1735010A	4.255,23	5.319,04	body 3000K w/presence detector, anthracite grey
		1735020A	4.255,23	5.319,04	body 3000K w/presence detector, white
		1735050A	4.255,23	5.319,04	body 3000K w/presence detector, opaque black
		1742010A	922,53	1.153,16	wall support anthracite grey
1742020A	922,53	1.153,16	wall support white		
1742050A	922,53	1.153,16	wall support opaque black		
				Complete lamp consists of 2 items.	

LED Not replaceable integrated LED source

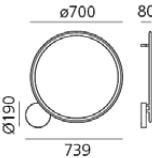
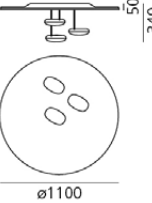
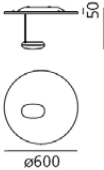
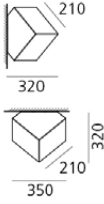

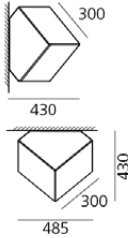


 Included source

 Excluded source



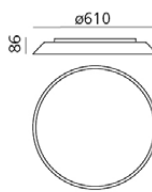
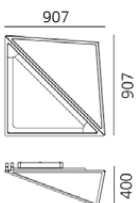
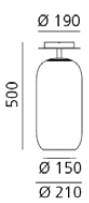

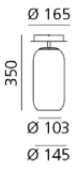

WALL OR CEILING LAMPS

		Code	Veil Pris NOK eks mva	Veil Pris NOK ink mva	
 <p>DEMETRA PROFESSIONAL WALL Naoto Fukasawa Wall lamp</p> <p>IP 20 LED 3000K, 12W, 960lm, CRI=90 Dimmer</p> <p>Materials: aluminum, technopolymer, steel</p>	1739010A	5.023,20	6.279,00	body lamp, anthracite grey	
	1739020A	5.023,20	6.279,00	body lamp, white	
	1739050A	5.023,20	6.279,00	body lamp, opaque black	
	1740010A	5.535,18	6.918,98	body w/presence detector, anthracite grey	
	1740020A	5.535,18	6.918,98	body w/presence detector, white	
	1740050A	5.535,18	6.918,98	body w/presence detector, opaque black	
	1742010A	922,53	1.153,16	wall support anthracite grey	
	1742020A	922,53	1.153,16	wall support white	
	1742050A	922,53	1.153,16	wall support opaque black	
Complete lamp consists of 2 items.					
 <p>DEMETRA MICRO WALL Naoto Fukasawa Wall lamp</p> <p>IP 20 LED 2700K, 6W, 241lm, CRI=90 Dimmer</p> <p>LED 3000K, 6W, 257lm, CRI=90 Dimmer</p> <p>Materials: aluminum, technopolymer</p>	1748W10A	3.023,58	3.779,48	2700K, anthracite grey	
	1748010A	3.023,58	3.779,48	3000K, anthracite grey	
	1748W20A	3.023,58	3.779,48	2700K, white	
	1748020A	3.023,58	3.779,48	3000K, white	
	1748W50A	3.023,58	3.779,48	2700K, opaque black	
	1748050A	3.023,58	3.779,48	3000K, opaque black	
 <p>DIOSCURI 14 WALL/CEILING Michele De Lucchi Wall or ceiling lamp</p> <p>IP44 LED DIM 1x4W (E14)  Dimmable</p> <p>Materials: blown glass, polycarbonate</p>	1039110A	1.642,20	2.052,75	white	
 <p>DIOSCURI 25 WALL/CEILING Michele De Lucchi Wall or ceiling lamp</p> <p>IP 65 LED DIM 1x15W (E27)  Dimmable</p> <p>Materials: blown glass, polycarbonate</p>	0112010A	2.922,15	3.652,69	white	
 <p>DIOSCURI 35 WALL/CEILING Michele De Lucchi Wall or ceiling lamp</p> <p>IP 65 LED DIM 1x21W (E27)  Dimmable</p> <p>Materials: blown glass, polycarbonate</p>	0116010A	3.791,55	4.739,44	white	
 <p>DIOSCURI 42 WALL/CEILING Michele De Lucchi Wall or ceiling lamp</p> <p>IP 65 LED DIM 1x21W (E27)  Dimmable</p> <p>Materials: blown glass, polycarbonate</p>	0117010A	4.863,81	6.079,76	white	

WALL OR CEILING LAMPS



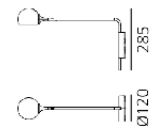
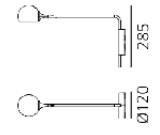
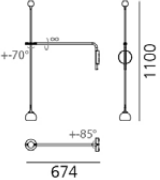
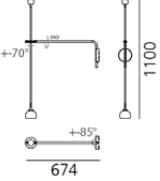
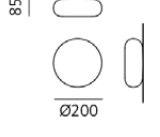


		Code	Veil Pris NOK eks mva	Veil Pris NOK ink mva	
 <p>DISCOVERY WALL Ernesto Gismondi Wall lamp</p> <p>IP 20 LED 3000K, 40W, 2857lm, CRI=90 Dimmable (Push)</p> <p>Materials: technopolymer, aluminum</p>	1998010A	17.837,19	22.296,49	transparent diffuser, satinised aluminium body lamp	
	1998030A	17.837,19	22.296,49	transparent diffuser, black body lamp	
	1998060A	17.837,19	22.296,49	transparent diffuser, body lamp bronze	
 <p>DROPLET LED CEILING Ross Lovegrove Ceiling lamp</p> <p>IP 20 LED 2700K, 3x29W, 3031lm, CRI=90 Dimmable (Push)</p> <p>LED 3000K, 3x29W, 3241lm, CRI=90 Dimmable (Push)</p> <p>Materials: aluminum, steel</p>	1474W10A	31.356,36	39.195,45	2700K, polished chrome brilliant	
	1474110A	31.356,36	39.195,45	3000K, polished chrome brilliant	
 <p>DROPLET MINI LED WALL/CEILING Ross Lovegrove Wall or ceiling lamp</p> <p>IP 20 LED 2700K, 29W, 1168lm, CRI=90 Dimmable (Push)</p> <p>LED 3000K, 29W, 1249lm, CRI=90 Dimmable (Push)</p> <p>Materials: aluminum, steel</p>	1471W10A	12.451,74	15.564,68	2700K, polished chrome brilliant	
	1471110A	12.451,74	15.564,68	3000K, polished chrome brilliant	
 <p>EDGE 21 WALL/CEILING Alessandro Mendini Wall or ceiling lamp</p> <p>IP 65 LED DIM 1x8W (E27)  Dimmable</p> <p>Materials: technopolymer</p>	1292010A	2.415,00	3.018,75	white	
 <p>EDGE 30 WALL/CEILING Alessandro Mendini Wall or ceiling lamp</p> <p>IP 65 LED DIM 1x8W (E27)  Dimmable</p> <p>Materials: technopolymer</p>	1293010A	2.709,63	3.387,04	white	
 <p>EMPATIA 16 WALL/CEILING Carlotta de Bevilacqua, Paola di Arianello Wall or ceiling lamp</p> <p>IP 20 LED 3000K, 11W, 567lm, CRI=90</p> <p>Materials: blown glass, methacrylate, aluminum</p>	1814010A	7.225,68	9.032,10	transparent smoked diffuser, white structure	

WALL OR CEILING LAMPS

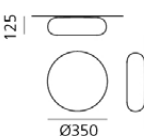




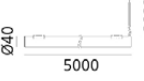
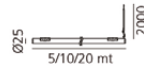
 <p>290 ø260</p>	<p>EMPATIA 26 WALL/CEILING Carlotta de Bevilacqua, Paola di Arianello Wall or ceiling lamp</p> <p>IP 20 LED 3000K, 16W, 710lm, CRI=90 Dimmable (Push)</p> <p>Materials: blown glass, methacrylate, aluminum</p>		1818010A	9.688,98	12.111,23	transparent smoked diffuser, white structure
 <p>380 ø360</p>	<p>EMPATIA 36 WALL/CEILING Carlotta de Bevilacqua, Paola di Arianello Wall or ceiling lamp</p> <p>IP 20 LED 3000K, 24W, 1273lm, CRI=90 Dimmable (Push)</p> <p>Materials: blown glass, methacrylate, aluminum</p>		1822010A	12.712,56	15.890,70	transparent smoked diffuser, white structure
 <p>88 ø610</p>	<p>FEBE WALL/CEILING Ernesto Gismondi, Daniele Moioli Wall or ceiling lamp</p> <p>IP 20 LED 2700K, 30W, 2182lm, CRI=90 Dimmable (Push)</p> <p>LED 3000K, 30W, 2260lm, CRI=90 Dimmable (Push)</p> <p>Materials: methacrylate, polycarbonate</p>		0241W00A	8.607,06	10.758,83	2700K, white
			0241300A	8.607,06	10.758,83	3000K, white
			0241W20A	8.607,06	10.758,83	2700K, dove grey
			0241320A	8.607,06	10.758,83	3000K, dove grey
 <p>907 907 400</p>	<p>FLEXIA WALL Mario Cucinella Wall lamp</p> <p>IP 20 LED 3000K, 65W, 6475lm, CRI=90 Dimmable (Push/APP - Push/Dali)</p> <p>Materials: PMMA, aluminum, polyester</p>		CC60000	25.695,60	32.119,50	green
			CC60300	25.695,60	32.119,50	light blue
			CC60400	25.695,60	32.119,50	orange
			CC90000	5.047,35	6.309,19	Power unit box Push/1-10/DALI
			CC90000APP	5.047,35	6.309,19	power unit box Artemide APP
 <p>500 ø 190 ø 150 ø 210</p>	<p>GOPLE CEILING BIG Ceiling lamp</p> <p>IP 20 LED 1x20W (E27) </p> <p>Materials: aluminum, white blown glass with nuances or blown glass with PVD treatment</p>		1413010A	9.672,08	12.090,09	structure and diffuser silver PVD
			1413020A	8.409,03	10.511,29	silver structure and nuanced white diffuser
			1413040A	9.672,08	12.090,09	silver structure and copper diffuser PVD
			1413050A	9.672,08	12.090,09	silver structure and blue sapphire diffuser PVD
			1413060A	9.672,08	12.090,09	silver structure and bronze diffuser PVD
			1413220A	8.196,51	10.245,64	white structure and nuanced white diffuser
			1413340A	9.454,73	11.818,41	black structure and copper diffuser PVD
			1413350A	9.454,73	11.818,41	black structure and blue sapphire diffuser PVD
			1413360A	9.454,73	11.818,41	black structure and bronze diffuser PVD
 <p>350 ø 165 ø 103 ø 145</p>	<p>GOPLE MINI CEILING BIG Ceiling lamp</p> <p>IP 20 LED 1x6W (E14) </p> <p>Materials: aluminum, white blown glass with nuances or blown glass with PVD treatment</p>		1414010A	5.590,73	6.988,41	structure and diffuser silver PVD
			1414020A	5.076,33	6.345,41	silver structure and nuanced white diffuser
			1414040A	5.590,73	6.988,41	silver structure and copper diffuser PVD
			1414050A	5.590,73	6.988,41	silver structure and blue sapphire diffuser PVD
			1414060A	5.590,73	6.988,41	silver structure and bronze diffuser PVD
			1414220A	4.974,90	6.218,63	white structure and nuanced white diffuser
			1414340A	5.385,45	6.731,81	black structure and copper diffuser PVD
			1414350A	5.385,45	6.731,81	black structure and blue sapphire diffuser PVD
			1414360A	5.385,45	6.731,81	black structure and bronze diffuser PVD

NEW





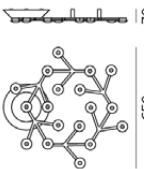
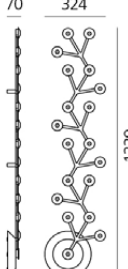
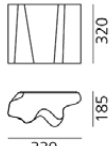

WALL OR CEILING LAMPS

 <p>HSIANG Mimmo Paladino Wall lamp</p> <p>IP 20 LED 41W, green, red, yellow and blue emotional light</p> <p>Materials: aluminum, steel, polycarbonate</p>	0201030A	38.741,43	48.426,79	black
 <p>ISLET Mikko Laakkonen Wall lamp</p> <p>IP 20 LED 3000K, 16W, 1344lm, CRI=90 Dimmable (Push)</p> <p>Materials: aluminum, technopolymer</p>	1627020A	3.791,55	4.739,44	white
 <p>IXA WALL Foster + Partners Wall lamp</p> <p>IP20 LED 3000K, 9W, 465lm, CRI=90 Dimmer</p> <p>Materials: aluminum, steel, technopolymer</p>	1113010A	4.404,96	5.506,20	anthracite
	1113020A	4.404,96	5.506,20	white/grey
	1113030A	4.404,96	5.506,20	blue
	1113040A	4.404,96	5.506,20	yellow
	1113000A	4.404,96	5.506,20	red
 <p>IXA WALL PLUG Foster + Partners Wall lamp</p> <p>IP20 LED 3000K, 9W, 465lm, CRI=90 Dimmer</p> <p>Materials: aluminum, steel, technopolymer</p>	1113050A	4.588,50	5.735,63	anthracite
	1113060A	4.588,50	5.735,63	white/grey
	1113070A	4.588,50	5.735,63	blue
	1113080A	4.588,50	5.735,63	yellow
	1113090A	4.588,50	5.735,63	red
 <p>IXA WALL L Foster + Partners Wall lamp</p> <p>IP20 LED 3000K, 9W, 465lm, CRI=90 Dimmer</p> <p>Materials: aluminum, steel, technopolymer</p>	1114010A	8.512,88	10.641,09	anthracite
	1114020A	8.512,88	10.641,09	white/grey
	1114030A	8.512,88	10.641,09	blue
	1114040A	8.512,88	10.641,09	yellow
	1114000A	8.512,88	10.641,09	red
 <p>IXA WALL L PLUG Foster + Partners Wall lamp</p> <p>IP20 LED 3000K, 9W, 465lm, CRI=90 Dimmer</p> <p>Materials: aluminum, steel, technopolymer</p>	1114050A	8.694,00	10.867,50	anthracite
	1114060A	8.694,00	10.867,50	white/grey
	1114070A	8.694,00	10.867,50	blue
	1114080A	8.694,00	10.867,50	yellow
	1114090A	8.694,00	10.867,50	red
 <p>ITKA 20 WALL/CEILING Naoto Fukasawa Wall or ceiling lamp</p> <p>IP 65 LED 1x5W (Gx53) </p> <p>Materials: blown glass, steel</p>	 DX0060M10	3.030,83	3.788,53	white





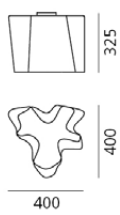

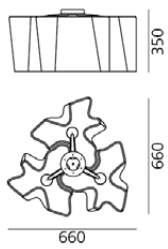

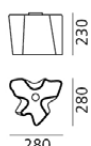

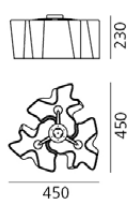

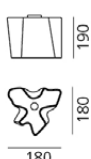

WALL OR CEILING LAMPS

	<p>ITKA 35 WALL/CEILING Naoto Fukasawa Wall or ceiling lamp IP 65 LED 3x4W (E14)  Materials: blown glass, steel</p>	<p>DANESE MILANO DX0060I10</p>	<p>4.177,95</p>	<p>5.222,44</p>	<p>white</p>
	<p>ITKA 50 WALL/CEILING Naoto Fukasawa Wall or ceiling lamp IP 65 LED 3x8W (E27)  Materials: blown glass, steel</p>	<p>DANESE MILANO DX0060E10</p>	<p>7.003,50</p>	<p>8.754,38</p>	<p>white</p>
	<p>LA LINEA 2,5mt BIG Wall, ceiling or floor lamp IP 65 LED 3000K, 13,2W/mt, 960lm/mt, CRI=95, 24 VDC Dimmable Materials: silicone</p>	<p>T4601010 DV1075 DV1075APP DV1076 A4681010 A4681010APP A4681210 T4681010APP T4601110 T4601210 T4601310</p>	<p>16.265,03 2.294,25 3.120,18 2.910,08 5.204,33 6.882,75 3.513,83 9.684,15 20.696,55 21.155,40 21.457,28</p>	<p>20.331,28 2.867,81 3.900,23 3.637,59 6.505,41 8.603,44 4.392,28 12.105,19 25.870,69 26.444,25 26.821,59</p>	<p>white driver 0-10V, ON-OFF - IP65 driver Push & APP - IP20 driver DALI, ON-OFF - IP65 power kit 96W DALI, 0-10V, Push - IP20 power kit 96W Push & APP - IP20 power kit 96W ND - IP20 power kit 96W Push & APP - IP65 La Linea 2,5mt + 2 kit recessed trimless La Linea 2,5mt + 2 kit recessed trim La Linea 2,5mt + 2 kit SMD (driver ON/OFF and fixing element)</p>
	<p>LA LINEA 5mt BIG Wall, ceiling or floor lamp IP 65 LED 3000K, 13,2W/mt, 960lm/mt, CRI=95, 24 VDC Dimmable Materials: silicone</p>	<p>T4600010 DV1075 DV1075APP DV1033 DV1076 A4681010 A4681010APP A4681210 T4681010APP T4600310 T4600410 T4600510</p>	<p>29.873,55 2.294,25 3.120,18 821,10 2.910,08 5.204,33 6.882,75 3.513,83 9.684,15 33.942,83 34.401,68 34.715,63</p>	<p>37.341,94 2.867,81 3.900,23 1.026,38 3.637,59 6.505,41 8.603,44 4.392,28 12.105,19 42.428,53 43.002,09 43.394,53</p>	<p>white driver 0-10V, ON-OFF - IP65 driver Push & APP - IP20 driver ON-OFF - IP20 driver DALI, ON-OFF - IP65 power kit 96W DALI, 0-10V, Push - IP20 power kit 96W Push & APP - IP20 power kit 96W ND - IP20 power kit 96W Push & APP - IP65 La Linea 5mt + 2 kit recessed trimless La Linea 5mt + 2 kit recessed trim La Linea 5mt + 2 kit SMD (driver ON/OFF and fixing element)</p>
	<p>LA LINEA 25 5mt BIG Wall, ceiling or floor lamp IP 65 LED 3000K, 12,5W/mt, 950lm/mt, CRI=90, 48 VDC Dimmable Materials: silicone</p>	<p>T4620010 DV1105 DV1105APP DV1106</p>	<p>12.340,65 3.767,40 4.588,50 3.972,68</p>	<p>15.425,81 4.709,25 5.735,63 4.965,84</p>	<p>white driver 0-10V - IP65 driver Push & APP - IP20 driver DALI - IP65</p>

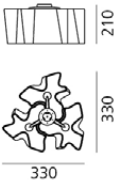

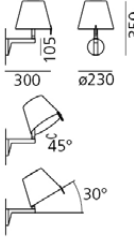




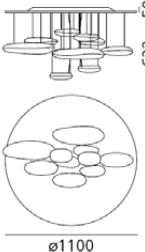
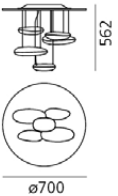
WALL OR CEILING LAMPS

 <p>Ø25 5/10/20 mt 2000</p>	LA LINEA 25 10mt	T4621010	23.039,10	28.798,88	white
	BIG Wall, ceiling or floor lamp	DV1105	3.767,40	4.709,25	driver 0-10V - IP65
	IP 65 LED 3000K, 12,5W/mt, 950lm/mt, CRI=90, 48 VDC Dimmable	DV1105APP	4.588,50	5.735,63	driver Push & APP - IP20
	Materials: silicone	DV1106	3.972,68	4.965,84	driver DALI - IP65
 <p>Ø25 5/10/20 mt 2000</p>	LA LINEA 25 20mt	T4622010	43.168,13	53.960,16	white
	BIG Wall, ceiling or floor lamp	DV1107	4.020,98	5.026,22	driver 0-10V - IP65
	IP 65 LED 3000K, 12,5W/mt, 950lm/mt, CRI=90, 48 VDC Dimmable	DV1107APP	4.938,68	6.173,34	driver Push & APP - IP20
	Materials: silicone	DV1108	4.081,35	5.101,69	driver DALI - IP65 From the Artemide.com website it is possible to download a template to create compositions such as "Earth" and "Tree"
 <p>Ø194 258 263</p>	LA PETITE WALL Andrea Quaglio, Manuela Simonelli Wall lamp	1752020A	2.970,45	3.713,06	white
	IP 20 LED DIM 1x6W (E14)  Dimmable	1752030A	2.970,45	3.713,06	black
 <p>70 650</p>	LED NET CIRCLE CEILING Michele De Lucchi, Alberto Nason Ceiling lamp	1594050APP	18.658,29	23.322,86	glossy white - Artemide APP
	IP 20 LED 3000K, 43W, 2502lm, CRI=80 Dimmable (Push & APP)				
 <p>70 324 1339</p>	LED NET LINE 125 CEILING Michele De Lucchi, Alberto Nason Ceiling lamp	1596050APP	19.315,17	24.143,96	glossy white - Artemide APP
	IP 20 LED 3000K, 45W, 2530lm, CRI=80 Dimmable (Push & APP)				
 <p>320 185 330</p>	LOGICO WALL Michele De Lucchi, Gerhard Reichert Wall lamp	0391030A	5.945,73	7.432,16	silk diffuser, grey structure
	IP 20 LED DIM 2x8W (E27)  Dimmable	0391010A	5.945,73	7.432,16	fumé diffuser, grey structure
Materials: blown glass, steel					




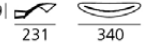



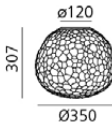

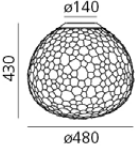



WALL OR CEILING LAMPS

		Code	Veil Pris NOK eks mva	Veil Pris NOK ink mva	
 <p>220 103 253</p>	<p>LOGICO MINI WALL Michele De Lucchi, Gerhard Reichert Wall lamp</p> <p>IP 20 LED DIM 1x8W (E27)  Dimmable</p> <p>Materials: blown glass, steel</p>	0395030A	3.583,86	4.479,83	silk diffuser, grey structure
 <p>189 103 189</p>	<p>LOGICO MICRO WALL Michele De Lucchi, Gerhard Reichert Wall lamp</p> <p>IP 20 LED DIM 1x6W (E14)  Dimmable</p> <p>Materials: blown glass, steel</p>	0846030A	2.873,85	3.592,31	silk diffuser, grey structure
 <p>325 400 400</p>	<p>LOGICO CEILING Michele De Lucchi, Gerhard Reichert Ceiling lamp</p> <p>IP 20 LED DIM 1x15W (E27)  Dimmable</p> <p>Materials: blown glass, aluminum</p>	0452020A	8.969,31	11.211,64	glass with silk effect diffuser
			0452010A	8.969,31	11.211,64
 <p>350 660 660</p>	<p>LOGICO CEILING 3x120° Michele De Lucchi, Gerhard Reichert Ceiling lamp</p> <p>IP 20 LED DIM 3x15W (E27)  Dimmable</p> <p>Materials: blown glass, aluminum</p>	0458020A	24.898,65	31.123,31	glass with silk effect diffuser
			0458010A	24.898,65	31.123,31
 <p>230 280 280</p>	<p>LOGICO MINI CEILING Michele De Lucchi, Gerhard Reichert Ceiling lamp</p> <p>IP 20 LED DIM 1x10W (E27)  Dimmable</p> <p>Materials: blown glass, aluminum</p>	0692020A	5.172,93	6.466,16	glass with silk effect diffuser
 <p>230 450 450</p>	<p>LOGICO MINI CEILING 3x120° Michele De Lucchi, Gerhard Reichert Ceiling lamp</p> <p>IP 20 LED DIM 3x10W (E27)  Dimmable</p> <p>Materials: blown glass, aluminum</p>	0693020A	14.649,39	18.311,74	glass with silk effect diffuser
 <p>190 180 180</p>	<p>LOGICO MICRO CEILING Michele De Lucchi, Gerhard Reichert Ceiling lamp</p> <p>IP 20 LED DIM 1x6W (E14)  Dimmable</p> <p>Materials: blown glass, aluminum</p>	0644020A	3.844,68	4.805,85	glass with silk effect diffuser

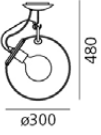


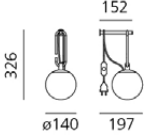

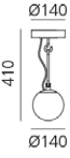

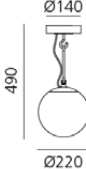

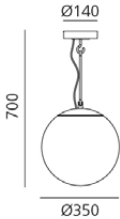

WALL OR CEILING LAMPS

 <p>210 330 330</p>	<p>LOGICO MICRO CEILING 3x120° Michele De Lucchi, Gerhard Reichert Ceiling lamp</p> <p>IP 20 LED DIM 3x6W (E14)  Dimmable</p> <p>Materials: blown glass, aluminum</p>	0645020A	9.790,41	12.238,01	glass with silk effect diffuser
 <p>105 300 ø230 45° 30°</p>	<p>MELAMPO WALL Adrien Gardère Wall lamp</p> <p>IP 20 LED DIM 1x6W (E14)  Dimmable</p> <p>Materials: technopolymer, silk satin, aluminum</p>	0720010A	2.762,76	3.453,45	structure and diffuser grey
		0720020A	2.762,76	3.453,45	structure bronze, diffuser neutral
		0721010A	2.922,15	3.652,69	structure and diffuser grey, with switch
		0721020A	2.922,15	3.652,69	structure bronze, diffuser neutral, with switch
 <p>55 228 138</p>	<p>MELETE Pio & Tito Toso Wall lamp</p> <p>IP 20 LED DIM 1x11W (R7s)  Dimmable</p> <p>Materials: aluminum</p>	1634010A	2.511,60	3.139,50	white
 <p>55 228 138</p>	<p>MELETE LED Pio & Tito Toso Wall lamp</p> <p>IP 20 LED 2700K, 27W, 2047lm, CRI=90 Dimmable (Push)</p> <p>LED 3000K, 27W, 2191lm, CRI=90 Dimmable (Push)</p> <p>Materials: aluminum</p>	1633W10A	3.173,31	3.966,64	2700K, white
		1633010A	3.173,31	3.966,64	3000K, white
 <p>622 50 ø1100</p>	<p>MERCURY LED CEILING Ross Lovegrove Ceiling lamp</p> <p>IP 20 LED 2700K, 2x29W, 2893lm, CRI=90 Dimmable (Push)</p> <p>LED 3000K, 2x29W, 3094lm, CRI=90 Dimmable (Push)</p> <p>Materials: aluminum, ABS, steel</p>	1366W10A	33.867,96	42.334,95	2700K, polished chrome brilliant
		1366110A	33.867,96	42.334,95	3000K, polished chrome brilliant
 <p>562 ø700</p>	<p>MERCURY MINI LED CEILING Ross Lovegrove Ceiling lamp</p> <p>IP 20 LED 2700K, 29W, 1447lm, CRI=90 Dimmable (Push)</p> <p>LED 3000K, 29W, 1547lm, CRI=90 Dimmable (Push)</p> <p>Materials: aluminum, ABS, steel</p>	1476W10A	16.141,86	20.177,33	2700K, polished chrome brilliant
		1476110A	16.141,86	20.177,33	3000K, polished chrome brilliant



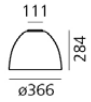



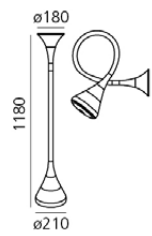
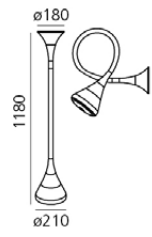


WALL OR CEILING LAMPS

<p>MESMERI</p> <p>79  221 340 Eric Solé Wall lamp</p> <p>92  IP 20 LED DIM 1x11W (R7s)  Dimmable</p> <p>Materials: aluminum</p>	0916010A	2.873,85	3.592,31	white
<p>MESMERI LED</p> <p>79  231 340 Eric Solé Wall lamp</p> <p>82  IP 20 LED 2700K, 28W, 2450lm, CRI=90 Dimmable (Push)</p> <p>LED 3000K, 28W, 2622lm, CRI=90 Dimmable (Push)</p> <p>Materials: aluminum</p>	0918W10A	3.791,55	4.739,44	2700K, white
	0918010A	3.791,55	4.739,44	3000K, white
	0918W20A	4.974,90	6.218,63	2700K, polished chrome brilliant
	0918020A	4.974,90	6.218,63	3000K, polished chrome brilliant
<p>METEORITE 15 WALL/CEILING</p> <p> 138 Pio & Tito Toso Wall or ceiling lamp</p> <p>IP 44 LED DIM 1x6W (E14)  Dimmable</p> <p>Materials: blown glass, technopolymer</p>	1704110A	2.250,78	2.813,48	white
<p>METEORITE 35 WALL/CEILING</p> <p> 307 Pio & Tito Toso Wall or ceiling lamp</p> <p>IP 20 LED DIM 1x21W (E27)  Dimmable</p> <p>Materials: blown glass, technopolymer</p>	1701010A	4.153,80	5.192,25	white
<p>METEORITE 48 CEILING</p> <p> 430 Pio & Tito Toso Ceiling lamp</p> <p>IP 20 LED DIM 1x21W (E27)  Dimmable</p> <p>Materials: blown glass, technopolymer</p>	1712010A	7.587,93	9.484,91	white
<p>MICONOS WALL</p> <p> Ernesto Gismondi Wall lamp</p> <p>IP 20 LED DIM 1x12W (E27)  Dimmable</p> <p>Materials: blown glass, steel</p>	A020100	5.385,45	6.731,81	crystal diffuser, polished chrome structure
	A020110	5.385,45	6.731,81	crystal diffuser, brass satinised structure


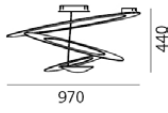




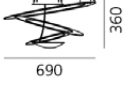

WALL OR CEILING LAMPS

 <p>Ernesto Gismondi Ceiling lamp</p> <p>IP 20 LED DIM 1x15W (E27)  Dimmable</p> <p>Materials: blown glass, steel</p>	A022800	5.684,91	7.106,14	crystal diffuser, polished chrome structure
	A022810	5.684,91	7.106,14	crystal diffuser, brass satinised structure
 <p>Neil Poulton Wall lamp</p> <p>IP 20 LED 3000K, 20W, 2116lm, CRI=82</p> <p>Materials: aluminum</p>	1646010A	3.284,40	4.105,50	white
 <p>Neri&Hu Wall lamp</p> <p>IP 20 LED 1x5W (E14) </p> <p>Materials: blown glass, brass, aluminium</p>	1277010A	3.173,31	3.966,64	white diffuser, brushed brass body, black wall support
 <p>Neri&Hu Ceiling lamp</p> <p>IP 20 LED DIM 1x5W (E14)  Dimmable</p> <p>Materials: blown glass, steel</p>	1284010A	4.202,10	5.252,63	white diffuser
 <p>Neri&Hu Ceiling lamp</p> <p>IP 20 LED DIM 1x15W (E27)  Dimmable</p> <p>Materials: blown glass, steel</p>	1285010A	4.974,90	6.218,63	white diffuser
 <p>Neri&Hu Ceiling lamp</p> <p>IP 20 LED DIM 1x20W (E27)  Dimmable</p> <p>Materials: blown glass, steel</p>	1286010A	5.796,00	7.245,00	white diffuser


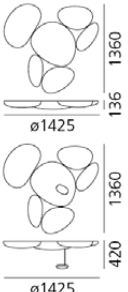

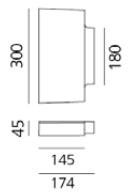



WALL OR CEILING LAMPS

		Code	Veil Pris NOK eks mva	Veil Pris NOK ink mva	
 <p>111 284 ø366</p>	NUR MINI CEILING Ernesto Gismondi Ceiling lamp IP 20 LED DIM 1x21W (E27)  Dimmable Materials: aluminum, methacrylate	A244200	5.226,06	6.532,58	anthracite grey
		A244250	4.404,96	5.506,20	aluminium grey
 <p>111 284 ø366</p>	NUR MINI LED CEILING Ernesto Gismondi Ceiling lamp IP 20 LED 2700K, 30W, 1287lm, CRI=90 Dimmable (Push) Materials: aluminum, methacrylate	A246500	7.124,25	8.905,31	anthracite grey
		A246510	6.404,58	8.005,73	aluminium grey
 <p>111 284 ø366</p>	NUR MINI GLOSS CEILING Ernesto Gismondi Ceiling lamp IP 20 LED DIM 1x21W (E27)  Dimmable Materials: aluminum, methacrylate	A245500	4.714,08	5.892,60	gloss white
		A245510	5.583,48	6.979,35	gloss black
 <p>111 284 ø366</p>	NUR MINI GLOSS LED CEILING Ernesto Gismondi Ceiling lamp IP 20 LED 2700K, 30W, 1287lm, CRI=90 Dimmable (Push) Materials: aluminum, methacrylate	A246600	6.718,53	8.398,16	gloss white
		A246610	7.587,93	9.484,91	gloss black
 <p>ø180 1180 ø210</p>	PIPE LED WALL/CEILING Herzog & de Meuron Wall or ceiling lamp IP 20 LED 2700K, 27W, 1763lm, CRI=90 Dimmable (Push) Materials: polycarbonate, steel, silicone	0671W10A	11.529,21	14.411,51	white translucent
 <p>ø180 1180 ø210</p>	PIPE LED WALL/CEILING WHITE INTEGRALIS Herzog & de Meuron Wall or ceiling lamp IP 20 LED 5000K, 27W, 2143lm, CRI=90 Dimmable (Push) Materials: polycarbonate, steel, silicone	0671010IN0A	11.529,21	14.411,51	white translucent
 <p>250 220 370</p>	PIRCE WALL Giuseppe Maurizio Scutellà Wall lamp IP 20 LED DIM 1x11W (R7s)  Dimmable Materials: aluminum	1240010A	4.404,96	5.506,20	white


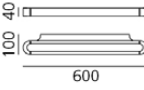
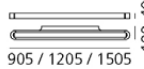


WALL OR CEILING LAMPS

		Code	Veil Pris NOK eks mva	Veil Pris NOK ink mva	
	<p>PIRCE MICRO LED WALL Giuseppe Maurizio Scutellà Wall lamp</p> <p>IP 20 LED 2700K, 27W, 2586lm, CRI=90 Dimmable (Push)</p> <p>LED 3000K, 27W, 2768lm, CRI=90 Dimmable (Push)</p> <p>Materials: aluminum</p>	1248W10A	4.042,71	5.053,39	2700K, white
		1248010A	4.042,71	5.053,39	3000K, white
		1248020A	4.042,71	5.053,39	3000K, gold
	<p>PIRCE CEILING Giuseppe Maurizio Scutellà Ceiling lamp</p> <p>IP 20 LED DIM 1x11W (R7s)  Dimmable</p> <p>Materials: aluminum</p>	1242010A	9.790,41	12.238,01	white
	<p>PIRCE LED CEILING Giuseppe Maurizio Scutellà Ceiling lamp</p> <p>IP 20 LED 2700K, 44W, 3097lm, CRI=90 Dimmable (Push)</p> <p>LED 3000K, 44W, 3313lm, CRI=90 Dimmable (Push)</p> <p>Materials: aluminum</p>	1253W10A	13.828,29	17.285,36	2700K, white
		1253110A	13.828,29	17.285,36	3000K, white
		1253120A	13.828,29	17.285,36	3000K, gold
	<p>PIRCE MINI CEILING Giuseppe Maurizio Scutellà Ceiling lamp</p> <p>IP 20 LED DIM 1x11W (R7s)  Dimmable</p> <p>Materials: aluminum</p>	1247010A	7.177,38	8.971,73	white
	<p>PIRCE MINI LED CEILING Giuseppe Maurizio Scutellà Ceiling lamp</p> <p>IP 20 LED 2700K, 44W, 3097lm, CRI=90 Dimmable (Push)</p> <p>LED 3000K, 44W, 3313lm, CRI=90 Dimmable (Push)</p> <p>Materials: aluminum</p>	1255W10A	11.331,18	14.163,98	2700K, white
		1255110A	11.331,18	14.163,98	3000K, white
		1255120A	11.331,18	14.163,98	3000K, gold
	<p>REA 12 Neil Poulton Wall lamp</p> <p>IP 20 LED 3000K, 8W, 731lm, CRI=82</p> <p>Materials: aluminum</p>	1614010A	2.415,00	3.018,75	white


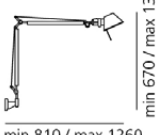

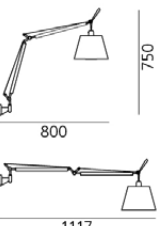

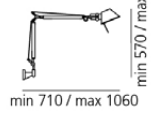
WALL OR CEILING LAMPS

	Code	Veil Pris NOK eks mva	Veil Pris NOK ink mva	
 <p>RELA 17 Neil Poulton Wall lamp</p> <p>IP 20 LED 3000K, 20W, 2193lm, CRI=82</p> <p>Materials: aluminum</p>	1615010A	3.284,40	4.105,50	white
 <p>SKYDRO LED Ross Lovegrove Ceiling lamp</p> <p>IP 20 LED 2700K, 29W, 1554lm, CRI=90 Dimmable (Push)</p> <p>LED 3000K, 29W, 1662lm, CRI=90 Dimmable (Push)</p> <p>Materials: aluminum, ABS, steel</p>	1245W10A	36.476,16	45.595,20	2700K, wired module
	1245110A	36.476,16	45.595,20	3000K, wired module
	1234010A	28.545,30	35.681,63	unwired module
	1235010A	3.071,88	3.839,85	kit for assembling more modules (template)
	1246010A	719,67	899,59	kit connection cables
 <p>STELLAR NEBULA CEILING BIG Ceiling lamp</p> <p>IP20 LED 3000K, 20W, 1890lm, CRI=80 Dimmable (Push)</p> <p>Materials: blown glass with PVD treatment, aluminum</p>	0152120A	16.045,26	20.056,58	transparent diffuser with dichroic PVD treatment
 <p>SURF WALL Neil Poulton Wall lamp</p> <p>IP 20 LED 3000K, 35W, 2930lm, CRI=80</p> <p>LED 3000K, 35W, 2930lm, CRI=80 Dimmable (DALI)</p> <p>LED 4000K, 35W, 3078lm, CRI=80</p> <p>LED 4000K, 35W, 3078lm, CRI=80 Dimmable (DALI)</p> <p>LED 1X11W (R7s) </p> <p>Materials: aluminum</p>	M060120	5.143,95	6.429,94	3000K, white
	M060121	5.602,80	7.003,50	3000K, white, DALI
	M060220	5.143,95	6.429,94	4000K, white
	M060221	5.602,80	7.003,50	4000K, white, DALI
	M060955	2.245,95	2.807,44	white
				electronic power supply included
 <p>TALO WALL Neil Poulton Wall lamp</p> <p>IP 20 LED DIM 1x11W (R7s) </p> <p>Dimmable</p> <p>Materials: aluminum, glass</p>	0613010A	2.970,45	3.713,06	white









WALL OR CEILING LAMPS

 <p>42 100 210</p>	<p>TALO LED WALL Neil Poulton Wall lamp</p> <p>IP 20 LED 2700K, 20W, 1674lm, CRI=90 Dimmable (Push)</p> <p>LED 3000K, 20W, 1991lm, CRI=90 Dimmable (Push)</p> <p>Materials: aluminum, methacrylate, polycarbonate</p>	0615W10A	3.791,55	4.739,44	2700K, white
		0615010A	3.791,55	4.739,44	3000K, white
		0615W30A	4.202,10	5.252,63	2700K, polished chrome brilliant
		0615030A	4.255,23	5.319,04	3000K, polished chrome brilliant
		0615W20A	3.791,55	4.739,44	2700K, silver
		0615020A	3.791,55	4.739,44	3000K, silver
		0615W80A	3.791,55	4.739,44	2700K, black matt
		0615080A	3.791,55	4.739,44	3000K, black matt
 <p>100 40 600</p>	<p>TALO 60 LED WALL Neil Poulton Wall lamp</p> <p>IP 20 LED 3000K, 25W, 3071lm, CRI=80 Not dimmable and dimmable (Push)</p> <p>Materials: aluminum, methacrylate, polycarbonate</p>	1913040A	6.665,40	8.331,75	not dimmable: opaque white
		1913050A	8.355,90	10.444,88	not dimmable: polished chrome brilliant
		1913080A	6.665,40	8.331,75	not dimmable: opaque black
		1914040A	7.887,39	9.859,24	dimmable: opaque white
		1914050A	9.688,98	12.111,23	dimmable: polished chrome brilliant
		1914080A	7.887,39	9.859,24	dimmable: opaque black
 <p>100 40 905 / 1205 / 1505</p>	<p>TALO (90, 120, 150) LED WALL Neil Poulton Wall lamp</p> <p>IP 20 Talo 90: LED 3000K, 32W, 3840lm, CRI=80 Not dimmable and dimmable (Push)</p> <p>Talo 120: LED 3000K, 51W, 6020lm, CRI=80 Not dimmable and dimmable (Push)</p> <p>Talo 150: LED 3000K, 60W, 7206lm, CRI=80 Not dimmable and dimmable (Push)</p> <p>Materials: aluminum, methacrylate, polycarbonate</p>	1915010A	8.297,94	10.372,43	TALO 90 LED: not dimmable, white
		1915020A	8.297,94	10.372,43	TALO 90 LED: not dimmable, silver
		1915080A	8.297,94	10.372,43	TALO 90 LED: non dimmerabile, nero opaco
		1916010A	9.838,71	12.298,39	TALO 90 LED: dimmable, white
		1916020A	9.838,71	12.298,39	TALO 90 LED: dimmable, silver
		1916080A	9.838,71	12.298,39	TALO 90 LED: dimmerabile, nero opaco
		1917010A	9.790,41	12.238,01	TALO 120 LED: not dimmable, white
		1917020A	9.790,41	12.238,01	TALO 120 LED: not dimmable, silver
		1917080A	9.790,41	12.238,01	TALO 120 LED: non dimmerabile, nero opaco
		1918010A	11.379,48	14.224,35	TALO 120 LED: dimmable, white
		1918020A	11.379,48	14.224,35	TALO 120 LED: dimmable, silver
		1918080A	11.379,48	14.224,35	TALO 120 LED: dimmerabile, nero opaco
		1919010A	11.070,36	13.837,95	TALO 150 LED: not dimmable, white
		1919020A	11.070,36	13.837,95	TALO 150 LED: not dimmable, silver
		1919080A	11.070,36	13.837,95	TALO 150 LED: non dimmerabile, nero opaco
		1920010A	12.712,56	15.890,70	TALO 150 LED: dimmable, white
1920020A	12.712,56	15.890,70	TALO 150 LED: dimmable, silver		
1920080A	12.712,56	15.890,70	TALO 150 LED: dimmerabile, nero opaco		
 <p>70 ø140</p>	<p>TETI Vico Magistretti Wall or ceiling lamp</p> <p>IP 20 LED DIM 1x6W (E27) ✕ Dimmable</p> <p>Materials: polycarbonate</p>	A048100	719,67	899,59	transparent
		A048110	719,67	899,59	transparent orange
		A048120	719,67	899,59	white
		A048150	719,67	899,59	anthracite grey
		A048170	719,67	899,59	orange
 <p>min 830 / max 1670 min 1030 / max 1670</p>	<p>TOLOMEO BRACCIO Michele De Lucchi, Giancarlo Fassina Wall lamp</p> <p>IP 20 LED 1x10,5W (E27) ✕</p> <p>Materials: aluminum</p>	A029050	4.303,53	5.379,41	body lamp and wall support: aluminium


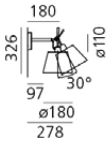

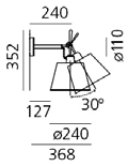

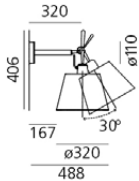




WALL OR CEILING LAMPS

 <p>min 830 / max 1670 min 1030 / max 1670</p>	<p>TOLOMEO BRACCIO LED Michele De Lucchi, Giancarlo Fassina Wall lamp</p> <p>IP 20 LED 2700K, 8W, 737lm, CRI=90 Dimmer</p> <p>LED 3000K, 8W, 761lm, CRI=90 Dimmer</p> <p>Materials: aluminum</p>	A0460W50	6.042,33	7.552,91	2700K, body lamp and wall support: aluminium
			A046050	6.042,33	7.552,91
 <p>min 670 / max 1310 min 810 / max 1260</p>	<p>TOLOMEO WALL Michele De Lucchi, Giancarlo Fassina Wall lamp</p> <p>IP 20 LED 1x10,5W (E27) ⚡</p> <p>Materials: aluminum, steel</p>	A001000	2.415,00	3.018,75	body lamp aluminium
		A004420	2.415,00	3.018,75	body lamp white
		A004430	2.415,00	3.018,75	body lamp black
		A025150	671,37	839,21	wall support aluminium
Complete lamp consists of 2 items.					
 <p>min 670 / max 1310 min 810 / max 1260</p>	<p>TOLOMEO LED WALL Michele De Lucchi, Giancarlo Fassina Wall lamp</p> <p>IP 20 LED 2700K, 8W, 737lm, CRI=90 Dimmer</p> <p>LED 3000K, 8W, 761lm, CRI=90 Dimmer</p> <p>LED Integralis: LED 3600K, 7W, 483lm, CRI= 80 Dimmer</p> <p>Materials: aluminum, steel</p>	A0048W00	3.434,13	4.292,66	2700K: body lamp aluminium
		A004800	3.434,13	4.292,66	3000K: body lamp aluminium
		A004800IN2	3.844,68	4.805,85	Integralis: body lamp
		A025150	671,37	839,21	wall support aluminium
Complete lamp consists of 2 items.					
 <p>750 800 1117</p>	<p>TOLOMEO BASCULANTE WALL Michele De Lucchi, Giancarlo Fassina Wall lamp</p> <p>IP 20 LED 1x8W (E27) ⚡</p> <p>Materials: parchment paper or silk satin, aluminum, steel</p>	0947010A	3.284,40	4.105,50	body lamp with parchment diffuser ø mm. 180
		0947020A	3.284,40	4.105,50	body lamp with silk diffuser ø mm. 180
		A025150	671,37	839,21	wall support aluminium
Complete lamp consists of 2 items.					
 <p>min 570 / max 1110 min 710 / max 1060</p>	<p>TOLOMEO MINI WALL Michele De Lucchi, Giancarlo Fassina Wall lamp</p> <p>IP 20 LED 1x10,5W (E27) ⚡</p> <p>Materials: aluminum, steel</p>	A005910	2.361,87	2.952,34	body lamp aluminium
		A005920	2.361,87	2.952,34	body lamp white
		A005940	2.361,87	2.952,34	body lamp black
		A025150	671,37	839,21	wall support aluminium
Complete lamp consists of 2 items.					
 <p>min 570 / max 1110 min 710 / max 1060</p>	<p>TOLOMEO MINI LED WALL Michele De Lucchi, Giancarlo Fassina Wall lamp</p> <p>IP 20 LED 2700K, 8W, 737lm, CRI=90 Dimmer</p> <p>LED 3000K, 8W, 761lm, CRI=90 Dimmer</p> <p>Materials: aluminum, steel</p>	A0056W00	3.434,13	4.292,66	2700K, body lamp aluminium
		A005600	3.434,13	4.292,66	3000K, body lamp aluminium
		A025150	671,37	839,21	wall support aluminium
Complete lamp consists of 2 items.					








WALL OR CEILING LAMPS

 <p>min 410 / max 740 min 490 / max 730</p>	<p>TOLOMEO MICRO WALL Michele De Lucchi, Giancarlo Fassina Wall lamp</p> <p>IP 20 LED 1x4W (E14) </p> <p>Materials: aluminum, steel</p>	A010900	2.202,48	2.753,10	body lamp only: aluminium
	A010910	2.202,48	2.753,10	body lamp only: anodized red	
	A010930	2.202,48	2.753,10	body lamp only: black	
	A010950	2.202,48	2.753,10	body lamp only: anodized bluee	
	A010960	2.202,48	2.753,10	body lamp only: anodized orange	
	0010920A	2.149,35	2.686,69	body lamp only: polished white	
	A025150	671,37	839,21	wall support aluminium	
				Complete lamp consists of 2 items.	
 <p>min 410 / max 740 min 490 / max 730</p>	<p>TOLOMEO MICRO LED WALL Michele De Lucchi, Giancarlo Fassina Wall lamp</p> <p>IP 20 LED 2700K, 7W, 620lm, CRI=90 Dimmer</p> <p>LED 3000K, 7W, 648lm, CRI=90 Dimmer</p> <p>Materials: aluminum, steel</p>	A0103W00	3.023,58	3.779,48	2700K, body lamp only: aluminium
	A010300	3.023,58	3.779,48	3000K, body lamp only: aluminium	
	A025150	671,37	839,21	wall support aluminium	
				Complete lamp consists of 2 items.	
 <p>250 230</p>	<p>TOLOMEO FARETTO Michele De Lucchi, Giancarlo Fassina Wall lamp</p> <p>IP 20 LED 1x10,5W (E27) </p> <p>Materials: aluminum</p>	A025450	1.888,53	2.360,66	without switch: aluminium
	A029250	2.052,75	2.565,94	with switch ON-OFF: aluminium	
 <p>250 230</p>	<p>TOLOMEO FARETTO LED Michele De Lucchi, Giancarlo Fassina Wall lamp</p> <p>IP 20 LED 2700K, 6W, 642lm, CRI=90, without switch</p> <p>LED 3000K, 6W, 671lm, CRI=90, without switch</p> <p>LED 2700K, 8W, 737lm, CRI=90</p> <p>LED 3000K, 8W, 761lm, CRI=90</p> <p>Materials: aluminum</p>	A0446W50	2.970,45	3.713,06	2700K, without switch, aluminium
	A044650	2.970,45	3.713,06	3000K, without switch, aluminium	
	A0447W50	3.434,13	4.292,66	2700K, with dimmable switch, aluminium	
	A044750	3.434,13	4.292,66	3000K, with dimmable switch, aluminium	
 <p>200</p>	<p>TOLOMEO MICRO FARETTO Michele De Lucchi, Giancarlo Fassina Wall lamp</p> <p>IP 20 LED 1x5W (E14) </p> <p>Materials: aluminum</p>	A010750	1.791,93	2.239,91	without switch, aluminium
	A044050	2.149,35	2.686,69	with incorporated switch, aluminium	


WALL OR CEILING LAMPS


	TOLOMEO MICRO FARETTO LED Michele De Lucchi, Giancarlo Fassina Wall lamp	A0435W00	2.825,55	3.531,94	2700K, without switch, aluminium
		A043500	2.825,55	3.531,94	3000K, without switch, aluminium
		A0436W00	3.284,40	4.105,50	2700K, with dimmable switch, aluminium
		A043600	3.284,40	4.105,50	3000K, with dimmable switch, aluminium
	IP 20 LED 2700K, 6W, 620lm, CRI=90, without switch LED 3000K, 6W, 648lm, CRI=90, without switch LED 2700K, 7W, 620lm, CRI=90 LED 3000K, 7W, 648lm, CRI=90 Materials: aluminum				
	TOLOMEO DIFFUSORE 18 WALL Michele De Lucchi, Giancarlo Fassina Wall lamp	1183010A	2.559,90	3.199,88	aluminium structure
		0780040A	1.019,13	1.273,91	parchment paper diffuser ø 180 mm
		0781040A	1.279,95	1.599,94	silk diffuser ø 180 mm
	IP 20 LED DIM 1x8W (E27)  Dimmable Materials: silk satin or parchment paper, aluminium				Complete lamp consists of 2 items.
	TOLOMEO DIFFUSORE 24 WALL Michele De Lucchi, Giancarlo Fassina Wall lamp	1184010A	2.559,90	3.199,88	aluminium structure
		0372050A	1.381,38	1.726,73	parchment paper diffuser ø 240 mm
		0781050A	1.429,68	1.787,10	silk diffuser ø 240 mm
	IP 20 LED DIM 1x17W (E27)  Dimmable Materials: silk satin or parchment paper, aluminium				Complete lamp consists of 2 items.
	TOLOMEO DIFFUSORE 32 WALL Michele De Lucchi, Giancarlo Fassina Wall lamp	1186010A	2.613,03	3.266,29	aluminium structure
		0780010A	1.642,20	2.052,75	parchment paper diffuser ø 320 mm
		0781010A	1.791,93	2.239,91	silk diffuser ø 320 mm
	IP 20 LED DIM 1x21W (E27)  Dimmable Materials: silk satin or parchment paper, aluminium				Complete lamp consists of 2 items.
	TOLOMEO PINZA Michele De Lucchi, Giancarlo Fassina Lamp with clip	A005800	1.888,53	2.360,66	with incorporated switch, aluminium
	IP 20 LED 1x10,5W (E27)  Materials: aluminium, steel				
	TOLOMEO PINZA LED Michele De Lucchi, Giancarlo Fassina Lamp with clip	A0448W50	2.922,15	3.652,69	2700K, with dimmable switch, aluminium
		A044850	2.922,15	3.652,69	3000K, with dimmable switch, aluminium
	IP 20 LED 2700K, 8W, 737lm, CRI=90 LED 3000K, 8W, 761lm, CRI=90 Materials: aluminium, steel				

WALL OR CEILING LAMPS




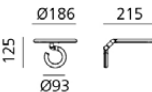
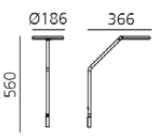
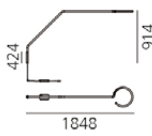
		Code	Veil Pris NOK eks mva	Veil Pris NOK ink mva	
 <p>TOLOMEO MICRO PINZA Michele De Lucchi, Giancarlo Fassina Lamp with clip</p> <p>IP 20 LED 1x5W (E14) </p> <p>Materials: aluminum, steel</p>	A010800	1.743,63	2.179,54	aluminium	
	A010810	1.791,93	2.239,91	red	
	A010850	1.791,93	2.239,91	blue	
	A010860	1.791,93	2.239,91	orange	
 <p>TOLOMEO MICRO PINZA LED Michele De Lucchi, Giancarlo Fassina Lamp with clip</p> <p>IP 20 LED 2700K, 9W, 461lm, CRI=90 LED 3000K, 9W, 461lm, CRI=90</p> <p>Materials: aluminum, steel</p>	A0438W00	2.762,76	3.453,45	2700K, aluminium	
	A043800	2.762,76	3.453,45	3000K, aluminium	
 <p>TOLOMEO MEGA WALL Michele De Lucchi, Giancarlo Fassina Wall lamp</p> <p>IP 20 Ø 320: LED / LED DIM* 1x21W (E27) </p> <p>Ø 360, 420: LED / LED DIM* 1x21W (E27) </p> <p>Materials: textile fabric or silk satin or parchment paper, aluminum, steel</p>	0564010A	3.892,98	4.866,23	body lamp with switch ON-OFF: aluminium	
	0564030A	3.892,98	4.866,23	body lamp with switch ON-OFF: black	
	0778010A	4.351,83	5.439,79	body lamp with dimmer: aluminium *	
	0778030A	4.351,83	5.439,79	body lamp with dimmer: black *	
	0780010A	1.642,20	2.052,75	parchment paper diffuser ø 320 mm	
	0780020A	1.743,63	2.179,54	parchment paper diffuser ø 360 mm	
	0780030A	1.840,23	2.300,29	parchment paper diffuser ø 420 mm	
	0781010A	1.791,93	2.239,91	silk diffuser ø 320 mm	
	0781020A	2.250,78	2.813,48	silk diffuser ø 360 mm	
	0781030A	2.415,00	3.018,75	silk diffuser ø 420 mm	
	0772010A	1.791,93	2.239,91	black satin diffuser ø 320 mm	
	0772020A	2.299,08	2.873,85	black satin diffuser ø 360 mm	
	0772030A	2.559,90	3.199,88	black satin diffuser ø 420 mm	
	0563050A	922,53	1.153,16	wall support aluminium	
				Complete lamp consists of 2 items.	
 <p>TOLOMEO MEGA LED WALL Michele De Lucchi, Giancarlo Fassina Wall lamp</p> <p>IP 20 LED 2700K*, 31W, CRI=90 Dimmer</p> <p>LED 3000K**, 31W, CRI=90 Dimmer</p> <p>Materials: textile fabric or silk satin or parchment paper, aluminum, steel</p>	0762W10A	6.506,01	8.132,51	2700K, body lamp with dimmer on cable: aluminium	
	0762010A	6.506,01	8.132,51	3000K, body lamp with dimmer on cable: aluminium	
	0762W30A	6.506,01	8.132,51	2700K, body lamp with dimmer on cable: black	
	0762030A	6.506,01	8.132,51	3000K, body lamp with dimmer on cable: black	
	0761W10A	5.684,91	7.106,14	2700K, body lamp with microswitch dimmer: aluminium	
	0761010A	5.684,91	7.106,14	3000K, body lamp with microswitch dimmer: aluminium	
	0761W30A	5.684,91	7.106,14	2700K, body lamp with microswitch dimmer: black	
	0761030A	5.684,91	7.106,14	3000K, body lamp with microswitch dimmer: black	
	0780010A	1.642,20	2.052,75	parchment paper diffuser ø 320 mm, 1868lm*/1999lm**	
	0780020A	1.743,63	2.179,54	parchment paper diffuser ø 360 mm, 1871lm*/2002lm**	
	0780030A	1.840,23	2.300,29	parchment paper diffuser ø 420 mm, 1884lm*/2016lm**	
	0781010A	1.791,93	2.239,91	silk diffuser ø 320 mm, 1770lm*/1894lm**	
	0781020A	2.250,78	2.813,48	silk diffuser ø 360 mm, 1786lm*/1912lm**	
	0781030A	2.415,00	3.018,75	silk diffuser ø 420 mm, 1789lm*/1914lm**	
	0772010A	1.791,93	2.239,91	black satin diffuser ø 320 mm, 1579lm*/ 1690lm**	
	0772020A	2.299,08	2.873,85	black satin diffuser ø 360 mm, 1571lm*/1681lm**	
	0772030A	2.559,90	3.199,88	black satin diffuser ø 420 mm, 1582lm*/1693lm**	
	0563050A	922,53	1.153,16	wall support aluminium	
			Complete lamp consists of 2 items.		

LED Not replaceable integrated LED source

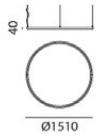
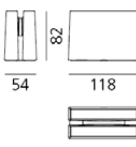
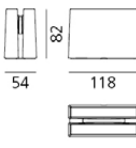
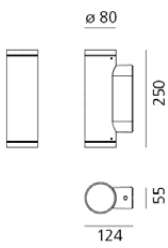
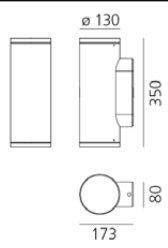
 Included source

 Excluded source

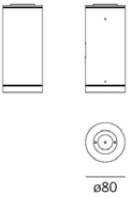
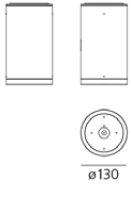
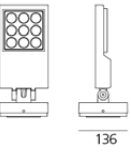
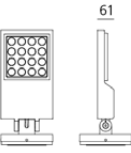
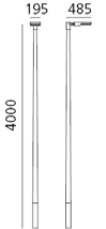
WALL OR CEILING LAMPS

		Code	Veil Pris NOK eks mva	Veil Pris NOK ink mva	
 <p>110 82 245 137 537</p>	<p>TWO FLAGS WALL Ernesto Gismondi, Neil Poulton Wall lamp</p> <p>IP 20 LED 3000K, 21W, 1688lm, CRI=90</p> <p>Materials: aluminum, borosilicate glass</p>	DEG8100A10L	4.020,98	5.026,22	white
		DEG8100A09L	4.020,98	5.026,22	black
double emission					
 <p>137 537</p>  <p>353 80 80 117 80</p>	<p>UNTERLINDEN WALL Herzog & de Meuron Wall lamp</p> <p>IP20 LED 2700K, 8W, 398lm, CRI=90</p> <p>LED 3000K, 8W, 416lm, CRI=90</p> <p>Materials: aluminum or brass, steel, technopolymer</p>	1097W10A	7.426,13	9.282,66	2700K, antique aluminum
		1097010A	7.426,13	9.282,66	3000K, antique aluminum
		1098W10A	8.102,33	10.127,91	2700K, antique brass
		1098010A	8.102,33	10.127,91	3000K, antique brass
NEW					
 <p>125 186 215 93</p>	<p>VINE LIGHT SPOT BIG Wall lamp</p> <p>IP20 LED 3000K, 8W, 602lm, CRI=90 Dimmer</p> <p>Materials: aluminum, zamac, technopolymer</p>	1566030A	5.076,33	6.345,41	black
 <p>560 186 366</p>	<p>VINE LIGHT WALL BIG Wall lamp</p> <p>IP20 LED 3000K, 8W, 602lm, CRI=90 Dimmer</p> <p>Materials: aluminum, zamac, technopolymer</p>	1567030A	5.274,36	6.592,95	black
 <p>424 914 1848</p>	<p>VINE LIGHT WALL L BIG Wall lamp</p> <p>IP20 LED 3000K, 35W, 2639lm, CRI=90 Dimmer</p> <p>Materials: aluminum, zamac, technopolymer</p>	1569030APP	13.944,21	17.430,26	black, Artemide APP

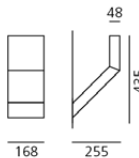
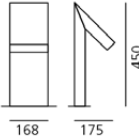
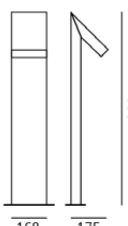
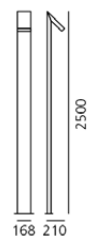
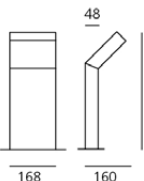

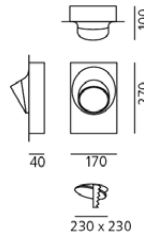
ARTEMIDE OUTDOOR

ARTEMIDE OUTDOOR				Code	Veil Pris NOK eks mva	Veil Pris NOK ink mva	
 <p>ALPHABET OF LIGHT OUTDOOR BIG Outdoor fixture</p> <p>IP 65 LED 3000K, 68W, 2200lm, CRI=90</p> <p>Materials: aluminum, optical silicone</p>	T089030	31.153,50	38.941,88	black			NEW
 <p>ANTARKTIKOS white light Carlotta de Bevilacqua Outdoor fixture</p> <p>IP 65 LED 3000K, 3W, 14lm, CRI=80 electronic ballast supplied separately</p> <p>Materials: aluminum</p>	T4520030	2.861,78	3.577,22	white light, grey/white RAL 9002			
	NL19035	374,33	467,91	driver LED 9,8W 700mA undimmable			
	DV3003	929,78	1.162,22	driver LED 14W 700mA IP67 undimmable			
	DV1003	809,03	1.011,28	driver LED 900mA 11-25W dimmable DALI/PUSH			
	DV1042	1.871,63	2.339,53	driver LED 55W 350-1000mA dimmable DALI IP67			
 <p>ANTARKTIKOS RGB Carlotta de Bevilacqua Outdoor fixture</p> <p>IP 65 LED 3000K, 3W, 15lm electronic ballast supplied separately</p> <p>Materials: aluminum</p>	T4521030	3.296,48	4.120,59	RGB light, grey/white RAL 9002			
	DV1055	1.122,98	1.403,72	driver LED 25W 12Vdc x max 5 devices in series			
	DV1056	1.243,73	1.554,66	driver LED 40W 12Vdc x max 8 devices in series			
	DV1057	1.243,73	1.554,66	driver LED 96W 12Vdc x max 12 devices in series			
	DV1043	2.052,75	2.565,94	driver LED 150W 12Vdc x max 30 devices in series			
	DV1059	1.678,43	2.098,03	driver DMX (1 device)			
	DV1052	1.678,43	2.098,03	driver DALI (1 device)			
 <p>CALUMET 8 WALL Ernesto Gismondi Wall fixture</p> <p>IP 65</p> <p>one emission: LED 3000K, 4W, 184lm, CRI=80 with electronic ballast</p> <p>double emission: LED 3000K, 7,5W, 369lm, CRI=80 with electronic ballast</p> <p>Materials: aluminum, tempered glass, methacrylate</p>	T41911NW00	5.965,05	7.456,31	One emission, grey/white RAL 9002			
	T41911NW10	5.965,05	7.456,31	One emission, anthracite grey			
	T41922NW00	7.643,48	9.554,34	Double emission, grey/white RAL 9002			
	T41922NW10	7.643,48	9.554,34	Double emission, anthracite grey			
 <p>CALUMET 13 WALL Ernesto Gismondi Wall fixture</p> <p>IP 65</p> <p>one emission: LED 3000K, 7,5W, 653lm, CRI=80 with electronic ballast</p> <p>double emission: LED 3000K, 15W, 1306lm, CRI=80 with electronic ballast</p> <p>Materials: aluminum, tempered glass, methacrylate</p>	T41941NW00	8.271,38	10.339,22	One emission, grey/white RAL 9002			
	T41941NW10	8.271,38	10.339,22	One emission, anthracite grey			
	T41952NW00	10.444,88	13.056,09	Double emission, grey/white RAL 9002			
	T41952NW10	10.444,88	13.056,09	Double emission, anthracite grey			

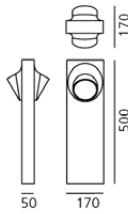
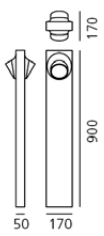
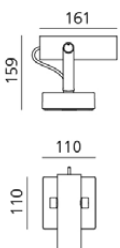
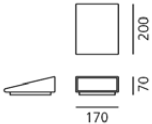
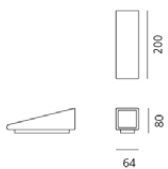
ARTEMIDE OUTDOOR

		Code	Veil Pris NOK eks mva	Veil Pris NOK ink mva	
 <p>CALUMET 8 CEILING Ernesto Gismondi Ceiling fixture</p> <p>IP 65 LED 3000K, 4W, 189lm, CRI=80 with electronic ballast</p> <p>Materials: aluminum, tempered glass, methacrylate</p>		T41931LW00	5.602,80	7.003,50	grey/white RAL 9002
		T41931LW10	5.602,80	7.003,50	anthracite grey
 <p>CALUMET 13 CEILING Ernesto Gismondi Ceiling fixture</p> <p>IP 65 LED 3000K, 7,5W, 554lm, CRI=80 with electronic ballast</p> <p>Materials: aluminum, tempered glass, methacrylate</p>		T41961LW00	7.583,10	9.478,88	grey/white RAL 9002
		T41961LW10	7.583,10	9.478,88	anthracite grey
 <p>CEFISO 14 Alessandro Pedretti (Studio Rota & P.) Floor/wall/cornice fixture</p> <p>IP 65</p> <p>spot optic 9°: LED 3000K, 23W, 1950lm, CRI=80 with electronic ballast</p> <p>flood optic 37°: LED 3000K, 23W, 1654lm, CRI=80 with electronic ballast</p> <p>wall washer optic 10°x37°: LED 3000K, 23W, 1596lm, CRI=80 with electronic ballast</p> <p>Materials: aluminum, tempered glass, methacrylate</p>		T418010W00	6.472,20	8.090,25	spot optic 5,4°, grey/white RAL 9002
		T418010W10	6.472,20	8.090,25	spot optic 5,4°, anthracite grey
		T418039W00	6.472,20	8.090,25	flood optic 40°, grey/white RAL 9002
		T418039W10	6.472,20	8.090,25	flood optic 40°, anthracite grey
		T4180ELW00	6.472,20	8.090,25	wall washer optic 6°x34°, grey/white RAL 9002
		T4180ELW10	6.472,20	8.090,25	wall washer optic 6°x34°, anthracite grey
 <p>CEFISO 20 Alessandro Pedretti (Studio Rota & P.) Floor/wall/cornice fixture</p> <p>IP 65</p> <p>spot optic 9°: LED 3000K, 38W, 3558lm, CRI=80 with electronic ballast</p> <p>flood optic 37°: LED 3000K, 38W, 3019lm, CRI=80 with electronic ballast</p> <p>wall washer optic 10°x37°: LED 3000K, 38W, 2912lm, CRI=80 with electronic ballast</p> <p>Materials: aluminum, tempered glass, methacrylate</p>		T418110W00	10.384,50	12.980,63	spot optic 5,4°, grey/white RAL 9002
		T418110W10	10.384,50	12.980,63	spot optic 5,4°, anthracite grey
		T418139W00	10.384,50	12.980,63	flood optic 40°, grey/white RAL 9002
		T418139W10	10.384,50	12.980,63	flood optic 40°, anthracite grey
		T4181ELW00	10.384,50	12.980,63	wall washer optic 6°x34°, grey/white RAL 9002
		T4181ELW10	10.384,50	12.980,63	wall washer optic 6°x34°, anthracite grey
 <p>CEFISO POLE Alessandro Pedretti (Studio Rota & P.) Lighting body and pole support</p> <p>IP 65 LED 3000K, 41W, 3110lm, CRI=80 with electronic ballast</p> <p>Materials: aluminum, tempered glass, methacrylate, zinked iron</p>		T418200W10	13.246,28	16.557,84	head pole, anthracite grey
		T418200W00	13.246,28	16.557,84	head pole, grey/white RAL 9002
					glass thickness 8mm - pole not supplied

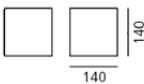

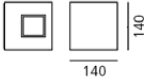
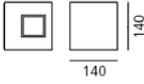
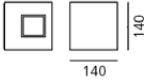
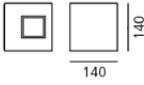
ARTEMIDE OUTDOOR

		Code	Veil Pris NOK eks mva	Veil Pris NOK ink mva	
 <p>CHILONE WALL Ernesto Gismondi Wall fixture</p> <p>IP 65 LED 3000K, 14W, 865lm, CRI=80 with electronic ballast</p> <p>Materials: aluminum, polycarbonate</p>		T082400	7.208,78	9.010,97	grey/white RAL 9002
		T082410	7.208,78	9.010,97	rust
		T082420	7.208,78	9.010,97	anthracite grey
 <p>CHILONE FLOOR 45 Ernesto Gismondi Outdoor floor lamp</p> <p>IP 65 LED 3000K, 8W, 350lm, CRI=80 with electronic ballast</p> <p>Materials: aluminum, polycarbonate</p>		T082200	8.017,80	10.022,25	grey/white RAL 9002
		T082210	8.017,80	10.022,25	rust
		T082220	8.017,80	10.022,25	anthracite grey
 <p>CHILONE FLOOR 90 Ernesto Gismondi Outdoor floor lamp</p> <p>IP 65 LED 3000K, 8W, 350lm, CRI=80 with electronic ballast</p> <p>Materials: aluminum, polycarbonate</p>		T082100	8.585,33	10.731,66	grey/white RAL 9002
		T082110	8.585,33	10.731,66	rust
		T082120	8.585,33	10.731,66	anthracite grey
 <p>CHILONE POLE 250 Ernesto Gismondi Outdoor floor lamp</p> <p>IP 65 LED 3000K, 14W, 628lm, CRI=80 with electronic ballast</p> <p>Materials: aluminum, polycarbonate</p>		T082000	13.427,40	16.784,25	grey/white RAL 9002
		T082010	13.427,40	16.784,25	rust
		T082020	13.427,40	16.784,25	anthracite grey
 <p>CHILONE UP FLOOR Ernesto Gismondi Outdoor floor lamp</p> <p>IP 65 LED 3000K, 14W, 865lm, CRI=80 with electronic ballast</p> <p>Materials: aluminum, polycarbonate</p>		T082300	7.583,10	9.478,88	grey/white RAL 9002
		T082310	7.583,10	9.478,88	rust
		T082320	7.583,10	9.478,88	anthracite grey
 <p>CICLOPE WALL Alessandro Pedretti Wall fixture</p> <p>IP 65 LED 3000K, 6,5W, 383lm, CRI=90 with electronic ballast</p> <p>Materials: composite technopolymer, polycarbonate, steel, aluminum</p>		T081200	8.585,33	10.731,66	grey/white RAL 9002
		T081210	8.585,33	10.731,66	rust
		T081220	8.585,33	10.731,66	anthracite grey
 <p>CICLOPE RECESSED Alessandro Pedretti Recessed fixture</p> <p>IP 65 LED 3000K, 6,5W, 383lm, CRI=90 with electronic ballast</p> <p>Materials: composite technopolymer, polycarbonate, steel, aluminum</p>		T081500	5.530,35	6.912,94	grey/white RAL 9002
		T081510	5.530,35	6.912,94	rust
		T081520	5.530,35	6.912,94	anthracite grey
		T081600	809,03	1.011,28	recessing box

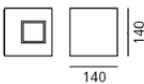

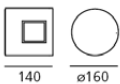

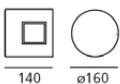

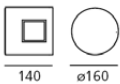

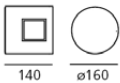

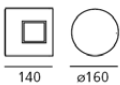

ARTEMIDE OUTDOOR

		Code	Veil Pris NOK eks mva	Veil Pris NOK ink mva	
 <p>CICLOPE FLOOR 50 Alessandro Pedretti Outdoor floor lamp</p> <p>IP 65</p> <p>one emission: LED 3000K, 6,5W, 383lm, CRI=90 with electronic ballast</p> <p>dual emission: LED 3000K, 13W, 765lm, CRI=90 with electronic ballast</p> <p>Materials: composite technopolymer, polycarbonate, steel, aluminum</p>	T081000	8.766,45	10.958,06	One emission, grey/white RAL 9002	
	T081010	8.766,45	10.958,06	One emission, rust	
	T081020	8.766,45	10.958,06	One emission, anthracite grey	
	T081300	10.819,20	13.524,00	Dual emission, grey/white RAL 9002	
	T081310	10.819,20	13.524,00	Dual emission, rust	
	T081320	10.819,20	13.524,00	Dual emission, anthracite grey	
 <p>CICLOPE FLOOR 90 Alessandro Pedretti Outdoor floor lamp</p> <p>IP 65</p> <p>Monolaterale: LED 3000K, 6,5W, 383lm, CRI=90 with electronic ballast</p> <p>dual emission: LED 3000K, 13W, 765lm, CRI=90 with electronic ballast</p> <p>Materials: composite technopolymer, polycarbonate, steel, aluminum</p>	T081100	9.515,10	11.893,88	One emission, grey/white RAL 9002	
	T081110	9.515,10	11.893,88	One emission, rust	
	T081120	9.515,10	11.893,88	One emission, anthracite grey	
	T081400	11.688,60	14.610,75	Dual emission, grey/white RAL 9002	
	T081410	11.688,60	14.610,75	Dual emission, rust	
	T081420	11.688,60	14.610,75	Dual emission, anthracite grey	
 <p>COHERENCE 2°, 5°, 10° Carlotta de Bevilacqua Outdoor spot fixture</p> <p>IP 65 LED 3000K, 9,5W, CRI=95 with electronic ballast</p> <p>Materials: aluminum</p>	T060030	11.881,80	14.852,25	black, spot optic 2°, 24lm, 18000cd	
	T060130	11.881,80	14.852,25	black, spot optic 5°, 90lm, 14500cd	
	T060230	11.881,80	14.852,25	black, spot optic 10°, 160lm, 7000cd	
 <p>CUNEO WALL/FLOOR Klaus Begasse Outdoor floor/ceiling fixture</p> <p>IP 65 LED 3000K, 15W, 1022lm, CRI=80 with electronic ballast</p> <p>Materials: aluminum, methacrylate</p>	T082700	6.339,38	7.924,22	grey/white RAL 9002	
	T082710	6.339,38	7.924,22	rust	
	T082720	6.339,38	7.924,22	anthracite grey	
 <p>CUNEO MINI WALL/FLOOR Klaus Begasse Outdoor floor/ceiling fixture</p> <p>IP 65 LED 3000K, 11W, 805lm, CRI=90 with electronic ballast</p> <p>Materials: aluminum, methacrylate</p>	T082800	3.851,93	4.814,91	grey/white RAL 9002	
	T082810	3.851,93	4.814,91	rust	
	T082820	3.851,93	4.814,91	anthracite grey	

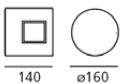
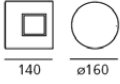
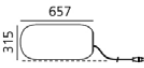

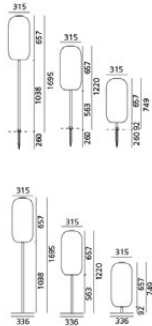

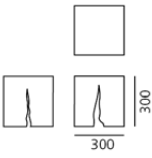

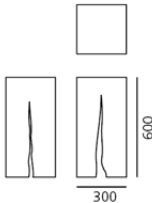

ARTEMIDE OUTDOOR

 <p>EFFETTO 14 SQUARE 1 large beam Ernesto Gismondi Outdoor wall fixture</p> <p>IP 65 LED 3000K, 4,6W, 54lm, CRI=80 with electronic ballast</p> <p>Materials: aluminum, composite technopolymer, methacrylate</p>	T42021LW00	4.419,45	5.524,31	grey/white RAL 9002
	T42021LW10	4.419,45	5.524,31	rust
	T42021LW20	4.419,45	5.524,31	anthracite grey
 <p>EFFETTO 14 SQUARE 1 narrow beam Ernesto Gismondi Outdoor wall fixture</p> <p>IP 65 LED 3000K, 4,6W, 19lm, CRI=80 with electronic ballast</p> <p>Materials: aluminum, composite technopolymer, methacrylate</p>	T42021NW00	4.419,45	5.524,31	grey/white RAL 9002
	T42021NW10	4.419,45	5.524,31	rust
	T42021NW20	4.419,45	5.524,31	anthracite grey
 <p>EFFETTO 14 SQUARE 2 large beams Ernesto Gismondi Outdoor wall fixture</p> <p>IP 65 LED 3000K, 7W, 109lm, CRI=80 with electronic ballast</p> <p>Materials: aluminum, composite technopolymer, methacrylate</p>	T42012LW00	5.409,60	6.762,00	grey/white RAL 9002
	T42012LW10	5.409,60	6.762,00	rust
	T42012LW20	5.409,60	6.762,00	anthracite grey
 <p>EFFETTO 14 SQUARE 2 narrow beams Ernesto Gismondi Outdoor wall fixture</p> <p>IP 65 LED 3000K, 7W, 38lm, CRI=80 with electronic ballast</p> <p>Materials: aluminum, composite technopolymer, methacrylate</p>	T42012NW00	5.409,60	6.762,00	grey/white RAL 9002
	T42012NW10	5.409,60	6.762,00	rust
	T42012NW20	5.409,60	6.762,00	anthracite grey
 <p>EFFETTO 14 SQUARE 1 large beam + 1 narrow beam Ernesto Gismondi Outdoor wall fixture</p> <p>IP 65 LED 3000K, 7W, 73lm, CRI=80 with electronic ballast</p> <p>Materials: aluminum, composite technopolymer, methacrylate</p>	T4201NLW00	5.409,60	6.762,00	grey/white RAL 9002
	T4201NLW10	5.409,60	6.762,00	rust
	T4201NLW20	5.409,60	6.762,00	anthracite grey
 <p>EFFETTO 14 SQUARE 4 large beams Ernesto Gismondi Outdoor wall fixture</p> <p>IP 65 LED 3000K, 11W, 218lm, CRI=80 with electronic ballast</p> <p>Materials: aluminum, composite technopolymer, methacrylate</p>	T42004LW00	7.027,65	8.784,56	grey/white RAL 9002
	T42004LW10	7.027,65	8.784,56	rust
	T42004LW20	7.027,65	8.784,56	anthracite grey




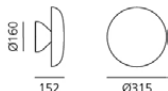
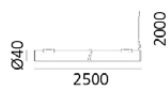

ARTEMIDE OUTDOOR

				Code	Veil Pris NOK eks mva	Veil Pris NOK ink mva	
 <p>EFFETTO 14 SQUARE 4 narrow beams Ernesto Gismondi Outdoor wall fixture</p>  <p>IP 65 LED 3000K, 11W, 76lm, CRI=80 with electronic ballast</p> <p>Materials: aluminum, composite technopolymer, methacrylate</p>	T42004NW00	7.088,03	8.860,03	grey/white RAL 9002			
	T42004NW10	7.088,03	8.860,03	rust			
	T42004NW20	7.088,03	8.860,03	anthracite grey			
 <p>EFFETTO ROUND 1 large beam Ernesto Gismondi Outdoor wall fixture</p>  <p>IP 65 LED 3000K, 4,6W, 54lm, CRI=80 with electronic ballast</p> <p>Materials: aluminum, composite technopolymer, methacrylate</p>	T42121LW00	4.419,45	5.524,31	grey/white RAL 9002			
	T42121LW10	4.419,45	5.524,31	rust			
	T42121LW20	4.419,45	5.524,31	anthracite grey			
 <p>EFFETTO ROUND 1 narrow beam Ernesto Gismondi Outdoor wall fixture</p>  <p>IP 65 LED 3000K, 4,6W, 23lm, CRI=80 with electronic ballast</p> <p>Materials: aluminum, composite technopolymer, methacrylate</p>	T42121NW00	4.419,45	5.524,31	grey/white RAL 9002			
	T42121NW10	4.419,45	5.524,31	rust			
	T42121NW20	4.419,45	5.524,31	anthracite grey			
 <p>EFFETTO ROUND 2 large beams Ernesto Gismondi Outdoor wall fixture</p>  <p>IP 65 LED 3000K, 7W, 100lm, CRI=80 with electronic ballast</p> <p>Materials: aluminum, composite technopolymer, methacrylate</p>	T42112LW00	5.409,60	6.762,00	grey/white RAL 9002			
	T42112LW10	5.409,60	6.762,00	rust			
	T42112LW20	5.409,60	6.762,00	anthracite grey			
 <p>EFFETTO ROUND 2 narrow beams Ernesto Gismondi Outdoor wall fixture</p>  <p>IP 65 LED 3000K, 7W, 49lm, CRI=80 with electronic ballast</p> <p>Materials: aluminum, composite technopolymer, methacrylate</p>	T42112NW00	5.409,60	6.762,00	grey/white RAL 9002			
	T42112NW10	5.409,60	6.762,00	rust			
	T42112NW20	5.409,60	6.762,00	anthracite grey			
 <p>EFFETTO ROUND 1 large beam + 1 narrow beam Ernesto Gismondi Outdoor wall fixture</p>  <p>IP 65 LED 3000K, 7W, 73lm, CRI=80 with electronic ballast</p> <p>Materials: aluminum, composite technopolymer, methacrylate</p>	T42111NLW00	5.409,60	6.762,00	grey/white RAL 9002			
	T42111NLW10	5.409,60	6.762,00	rust			
	T42111NLW20	5.409,60	6.762,00	anthracite grey			




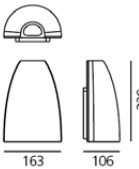
ARTEMIDE OUTDOOR

	Code	Veil Pris NOK eks mva	Veil Pris NOK ink mva	
 <p>EFFETTO ROUND 4 large beams Ernesto Gismondi Outdoor wall fixture</p> <p>IP 65 LED 3000K, 11W, 205lm, CRI=80 with electronic ballast</p> <p>Materials: aluminum, composite technopolymer, methacrylate</p>	T42104LW00	7.027,65	8.784,56	grey/white RAL 9002
	T42104LW10	7.027,65	8.784,56	rust
	T42104LW20	7.027,65	8.784,56	anthracite grey
 <p>EFFETTO ROUND 4 narrow beams Ernesto Gismondi Outdoor wall fixture</p> <p>IP 65 LED 3000K, 11W, 102lm, CRI=80 with electronic ballast</p> <p>Materials: aluminum, composite technopolymer, methacrylate</p>	T42104NW00	7.088,03	8.860,03	grey/white RAL 9002
	T42104NW10	7.088,03	8.860,03	rust
	T42104NW20	7.088,03	8.860,03	anthracite grey
 <p>GOPLÉ OUTDOOR BIG Floor/suspension fixture</p> <p>IP 44 LED 1x21W (E27) </p> <p>Materials: polyethylene diffuser</p>	T040020	6.713,70	8.392,13	body lamp
	T040120	869,40	1.086,75	accessory: suspension kit
				Complete lamp consists of 2 items.
 <p>GOPLÉ OUTDOOR BOLLARD BIG Floor/suspension fixture</p> <p>IP 44 LED 1x21W (E27) </p> <p>Materials: polyethylene diffuser</p>	T040020	6.713,70	8.392,13	body lamp
	T040220	1.557,68	1.947,09	stem h 88
	T040320	2.306,33	2.882,91	stem h 563
	T040420	2.668,58	3.335,72	stem h 1038
	T040520	1.871,63	2.339,53	stem base
	T040620	1.304,10	1.630,13	spike
				Complete lamp consists of 2 items.
 <p>GRANITO 30 Ernesto Gismondi Outdoor floor lamp</p> <p>IP 65 1x35W metal halide (G 12) </p> <p>with electronic ballast</p> <p>Materials: steel cor-ten, glass</p>	T083000	9.333,98	11.667,47	rust cor-ten
 <p>GRANITO 60 Ernesto Gismondi Outdoor floor lamp</p> <p>IP 65 1x35W metal halide (G 12) </p> <p>with electronic ballast</p> <p>Materials: steel cor-ten, glass</p>	T083100	11.314,28	14.142,84	rust cor-ten

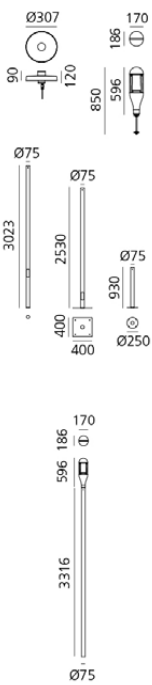
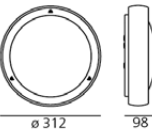

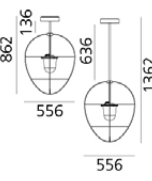
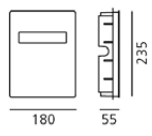
ARTEMIDE OUTDOOR

 <p>KNOP 45 BOLLARD BIG Outdoor floor lamp</p> <p>IP 65 LED 3000K, 11W, 950lm, CRI=90 with electronic ballast</p> <p>Materials: aluminum, technopolymer</p>	T090000	8.017,80	10.022,25	brushed grey	NEW
 <p>KNOP 90 BOLLARD BIG Outdoor floor lamp</p> <p>IP 65 LED 3000K, 11W, 950lm, CRI=90 with electronic ballast</p> <p>Materials: aluminum, technopolymer</p>	T090100	8.500,80	10.626,00	brushed grey	NEW
 <p>KNOP 225 BOLLARD BIG Outdoor floor lamp</p> <p>IP 65 LED 3000K, 16W, 1250lm, CRI=90 with electronic ballast</p> <p>Materials: aluminum, technopolymer</p>	T090200	10.094,70	12.618,38	brushed grey	NEW
 <p>KNOP WALL/CEILING BIG Outdoor wall/ceiling fixture</p> <p>IP 65 LED 3000K, 11W, 950lm, CRI=90 with electronic ballast</p> <p>Materials: aluminum, technopolymer</p>	T090300	7.389,90	9.237,38	brushed grey	NEW
 <p>LA LINEA 2,5mt BIG</p> <p>IP 65 LED 3000K, 13,2W/mt, 960lm/mt, CRI=95, 24 VDC Dimmable</p> <p>Materials: silicone</p>	T4601010	16.265,03	20.331,28	white	
	DV1075	2.294,25	2.867,81	driver 0-10V, ON-OFF - IP65	
	DV1076	2.910,08	3.637,59	driver DALI, ON-OFF - IP65	
	A4681210	3.513,83	4.392,28	power kit 96W ND - IP65	
	T4681010APP	9.684,15	12.105,19	power kit 96W Push & APP - IP65	
 <p>LA LINEA 5mt BIG Outdoor floor lamp</p> <p>IP 65 LED 3000K, 13,2W/mt, 960lm/mt, CRI=95, 24 VDC Dimmable</p> <p>Materials: silicone</p>	T4600010	29.873,55	37.341,94	white	
	DV1075	2.294,25	2.867,81	driver 0-10V, ON-OFF - IP65	
	DV1076	2.910,08	3.637,59	driver DALI, ON-OFF - IP65	
	A4681210	3.513,83	4.392,28	power kit 96W ND - IP65	
	T4681010APP	9.684,15	12.105,19	power kit 96W Push & APP - IP65	

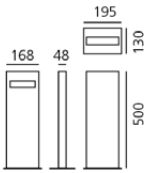
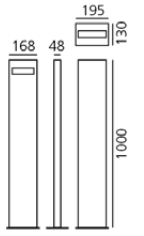
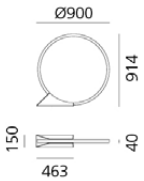
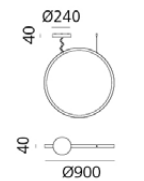
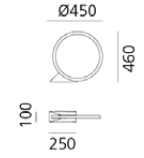
ARTEMIDE OUTDOOR

 <p>LA LINEA 25 5mt BIG Outdoor wall/ceiling/floor fixture</p> <p>IP 65 LED 3000K, 12,5W/mt, 950lm/mt, CRI=90, 48 VDC Dimmable</p> <p>Materials: silicone</p>	T4620010	12.340,65	15.425,81	white
	DV1105	3.767,40	4.709,25	driver 0-10V - IP65
	DV1106	3.972,68	4.965,84	driver DALI - IP65
 <p>LA LINEA 25 10mt BIG Outdoor wall/ceiling/floor fixture</p> <p>IP 65 LED 3000K, 12,5W/mt, 950lm/mt, CRI=90, 48 VDC Dimmable</p> <p>Materials: silicone</p>	T4621010	23.039,10	28.798,88	white
	DV1105	3.767,40	4.709,25	driver 0-10V - IP65
	DV1106	3.972,68	4.965,84	driver DALI - IP65
 <p>LA LINEA 25 20mt BIG Outdoor wall/ceiling/floor fixture</p> <p>IP 65 LED 3000K, 12,5W/mt, 950lm/mt, CRI=90, 48 VDC Dimmable</p> <p>Materials: silicone</p>	T4622010	43.168,13	53.960,16	white
	DV1107	4.020,98	5.026,22	driver 0-10V - IP65
	DV1108	4.081,35	5.101,69	driver DALI - IP65
				From the Artemide.com website it is possible to download a template to create compositions such as "Earth" and "Tree"
 <p>MOLLA Ernesto Gismondi Outdoor wall fixture</p> <p>IP 65 LED 3000K, 12W, 618lm, CRI=90 with electronic ballast</p> <p>Materials: aluminum, composite technopolymer, methacrylate, silkscreened glass</p>	T4190NLW00	6.339,38	7.924,22	grey/white RAL 9002
	T4190NLW10	6.339,38	7.924,22	anthracite grey




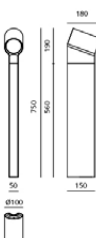
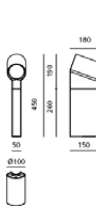

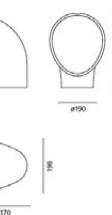
ARTEMIDE OUTDOOR

		Code	Veil Pris NOK eks mva	Veil Pris NOK ink mva	
 <p>NEEDOO Davide Oppizzi Outdoor floor lamp</p> <p>IP 65 Rotosymmetrical monoemission: LED 3000K, 11W, 337lm, CRI=90 with electronic ballast</p> <p>Asymmetrical monoemission: LED 3000K, 11W, 455lm, CRI=90 with electronic ballast</p> <p>Asymmetrical double emission: LED 3000K, 21W, 910lm, CRI=90 with electronic ballast</p> <p>Double emission (asymmetrical+blade of light): LED 3000K, 13W, 478lm, CRI=80 with electronic ballast</p> <p>Monoemission blade of light: LED 3000K, 4W, 23lm, CRI=80 with electronic ballast</p> <p>Materials: aluminum, steel, polycarbonate</p>		T030000	8.090,25	10.112,81	Rotosymmetrical monoemission, rust
		T030010	8.090,25	10.112,81	Rotosymmetrical monoemission, green
		T030100	8.090,25	10.112,81	Asymmetrical monoemission, rust
		T030110	8.090,25	10.112,81	Asymmetrical monoemission, green
		T030200	10.130,93	12.663,66	Asymmetrical double emission, rust
		T030210	10.130,93	12.663,66	Asymmetrical double emission, green
		T030300	9.696,23	12.120,28	Double emission (asymmetrical + blade of light), rust
		T030310	9.696,23	12.120,28	Double emission (asymmetrical + blade of light), green
		T030400	8.452,50	10.565,63	Monoemission blade of light, rust
		T030410	8.452,50	10.565,63	Monoemission blade of light, green
		T031000	6.097,88	7.622,34	pole h.90cm, rust
		T031010	6.097,88	7.622,34	pole h.90cm, green
		T031100	10.505,25	13.131,56	pole h.250cm, rust
		T031110	10.505,25	13.131,56	pole h.250cm, green
		T031200	8.211,00	10.263,75	pole h.300cm, rust
		T031210	8.211,00	10.263,75	pole h.300cm, green
		T031300	7.208,78	9.010,97	pole h.330cm for nest, rust
		T031310	7.208,78	9.010,97	pole h.330cm for nest, rust
		T031800	1.871,63	2.339,53	reduction for head installation on commercial pole Ø60mm, rust
		T031810	1.871,63	2.339,53	reduction for head installation on commercial pole Ø60mm, green
		T031900	2.052,75	2.565,94	reduction for nest installation on commercial pole Ø60mm, rust
		T031910	2.052,75	2.565,94	reduction for nest installation on commercial pole Ø60mm, green
		T032000	2.113,13	2.641,41	raccordo da testa a nido, ruggine
		T032010	2.113,13	2.641,41	raccordo da testa a nido, verde
		T031400	11.447,10	14.308,88	nest body, rust
		T031410	11.447,10	14.308,88	nest body, green
		T031700	2.668,58	3.335,72	nesting hatch hole Ø 26
		T031710	2.668,58	3.335,72	nesting hatch hole Ø 32
		T031720	2.668,58	3.335,72	nesting hatch hole Ø 45
		T031730	2.668,58	3.335,72	nesting hatch hole 55X29
T031740	2.668,58	3.335,72	nesting hatch 3 holes Ø 26		
T031750	2.668,58	3.335,72	nesting hatch hole 84X93		
T031760	4.226,25	5.282,81	nesting hatch for bat		
 <p>NIKI Ernesto Gismondi Outdoor wall fixture/soffitto</p> <p>IP 65 1x13W (E27)  with electronic ballast</p> <p>Materials: steel, prism glass</p>		AH10013	2.741,03	3.426,28	LED Retrofit: gloss
		AH10015	2.741,03	3.426,28	LED Retrofit: satinised
 <p>NOTTOLA Alexander Bellman Outdoor suspension fixture</p> <p>IP 65 LED 3000K, 20W, 2034lm, CRI=90</p> <p>Materials: steel, polycarbonate</p>		T070010	19.283,78	24.104,72	brass
					the product is supplied with two interchangeable tiges, which allow to obtain two different lengths
 <p>NUDA RECESSED Ernesto Gismondi Outdoor recessed fixture</p> <p>IP 65 LED 3000K, 8W, 316lm, CRI=80 with electronic ballast</p> <p>Materials: aluminum, polycarbonate</p>		T083500	5.602,80	7.003,50	grey/white RAL 9002
		T083510	5.602,80	7.003,50	rust
		T083520	5.602,80	7.003,50	anthracite grey
		T083400	495,08	618,84	recessing box

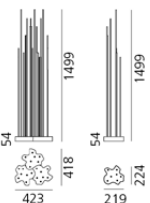
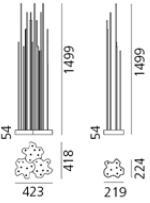
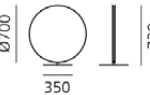
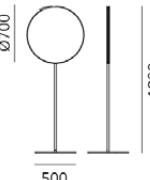
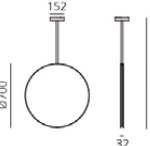
ARTEMIDE OUTDOOR

 <p>NUDA 50 Ernesto Gismondi Outdoor floor lamp</p> <p>IP 65</p> <p>one emission: LED 3000K, 8W, 316lm, CRI=80 with electronic ballast</p> <p>dual emission: LED 3000K, 8W, 335lm, CRI=80 with electronic ballast</p> <p>Materials: aluminum, polycarbonate</p>	T083600	6.906,90	8.633,63	One emission, grey/white RAL 9002
	T083610	6.906,90	8.633,63	One emission, rust
	T083620	6.906,90	8.633,63	One emission, anthracite grey
	T083700	7.148,40	8.935,50	Dual emission, grey/white RAL 9002
	T083710	7.148,40	8.935,50	Dual emission, rust
	T083720	7.148,40	8.935,50	Dual emission, anthracite grey
 <p>NUDA 100 Ernesto Gismondi Outdoor floor lamp</p> <p>IP 65</p> <p>one emission: LED 3000K, 14W, 563lm, CRI=80 with electronic ballast</p> <p>one emission: LED 3000K, 14W, 363lm, CRI=80 with electronic ballast</p> <p>one emission: LED 3000K, 14W, 563lm, CRI=80 with electronic ballast</p> <p>dual emission: LED 3000K, 14W, 596lm, CRI=80 with electronic ballast</p> <p>Materials: aluminum, polycarbonate</p>	T083800	7.401,98	9.252,47	One emission, grey/white RAL 9002
	T083810	7.401,98	9.252,47	One emission, rust
	T083820	7.401,98	9.252,47	One emission, anthracite grey
	T083900	7.715,93	9.644,91	Dual emission, grey/white RAL 9002
	T083910	7.715,93	9.644,91	Dual emission, rust
	T083920	7.715,93	9.644,91	Dual emission, anthracite grey
 <p>"O" Elemental Outdoor floor lamp</p> <p>IP 67 LED 3000K, 43W, 1830lm, CRI=90</p> <p>Materials: aluminum, silicone</p>	T071030	14.924,70	18.655,88	black
 <p>"O" SUSPENSION Elemental Outdoor suspension lamp</p> <p>IP 67 LED 3000K, 43W, 1830lm, CRI=90</p> <p>Materials: aluminum, silicone</p>	T072030	12.618,38	15.772,97	black
 <p>"O" 45 FLOOR/WALL/CEILING Elemental Outdoor floor/wall lamp</p> <p>IP 67 LED 3000K, 19W, 875lm, CRI=90</p> <p>Materials: aluminum, silicone</p>	T071130	9.515,10	11.893,88	black

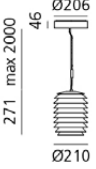
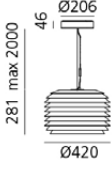
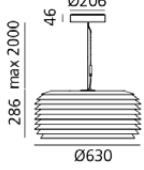

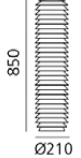
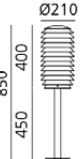
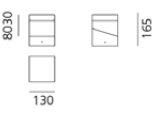
ARTEMIDE OUTDOOR

 <p>"O" 45 SUSPENSION Elemental Outdoor suspension lamp</p> <p>IP 67 LED 3000K, 19W, 875lm, CRI=90</p> <p>Materials: aluminum, silicone</p>	T072130	8.826,83	11.033,53	black
 <p>"O" 150 Elemental Outdoor floor lamp</p> <p>IP 67 LED 3000K, 65W, 3126lm, CRI=90</p> <p>Materials: aluminum, silicone</p>	T071230	40.861,80	51.077,25	black
 <p>"O" 150 SUSPENSION Elemental Outdoor suspension lamp</p> <p>IP 67 LED 3000K, 65W, 3126lm, CRI=90</p> <p>Materials: aluminum, silicone</p>	T072230	30.477,30	38.096,63	black
 <p>OBLIQUE BOLLARD 75 Arik Levy Outdoor floor lamp</p> <p>IP 65 LED 3000K, 23W, 1263lm, CRI=90 with electronic ballast</p> <p>Materials: aluminum</p>	T086300	6.592,95	8.241,19	anthracite grey
	T086500	748,65	935,81	ground picket
 <p>OBLIQUE BOLLARD 45 Arik Levy Outdoor floor lamp</p> <p>IP 65 LED 3000K, 20W, 1088lm, CRI=90 with electronic ballast</p> <p>Materials: aluminum</p>	T086200	5.904,68	7.380,84	anthracite grey
	T086500	748,65	935,81	ground picket
 <p>OBLIQUE WALL/FLOOR/POLE Arik Levy Wall/floor/pole fixture</p> <p>IP 65 LED 3000K, 23W, 1263lm, CRI=90 with electronic ballast</p> <p>Materials: aluminum</p>	T086000	4.600,58	5.750,72	anthracite grey
	T086020	4.600,58	5.750,72	white
	T086400	8.331,75	10.414,69	pole H. 3mt.
	T086500	748,65	935,81	ground picket
 <p>PIROSCAFO Ernesto Gismondi Outdoor floor lamp</p> <p>IP 65 LED 3000K, 14W, 1143lm, CRI=90 with electronic ballast</p> <p>Materials: aluminum, tempered glass</p>	T081900	5.844,30	7.305,38	grey
	T081910	5.844,30	7.305,38	rust
	T081920	5.844,30	7.305,38	green

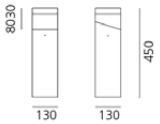


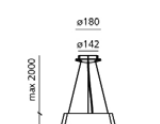
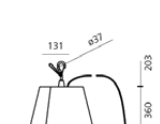
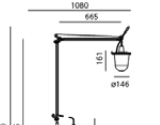
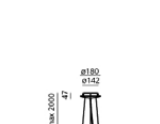
ARTEMIDE OUTDOOR

 <p>REEDS IP 67 Klaus Begasse Outdoor floor lamp</p> <p>IP 67</p> <p>Single: LED 3000K, 8W, 105lm, CRI=80 with electronic ballast</p> <p>Triple: LED 3000K, 24W, 314lm, CRI=80 with electronic ballast</p> <p>Materials: methacrylate, polycarbonate</p>	T087400	9.333,98	11.667,47	Single, anthracite grey	
	T087700	20.587,88	25.734,84	Triple, anthracite grey	
 <p>REEDS IP 68 Klaus Begasse Outdoor floor lamp</p> <p>IP 68</p> <p>Single: LED 3000K, 8W, 105lm, CRI=80 Driver 24Vdc SELV supplied separately</p> <p>Triple: LED 3000K, 24W, 314lm, CRI=80 Driver 24Vdc SELV supplied separately</p> <p>Materials: methacrylate, polycarbonate</p>	T087500	8.585,33	10.731,66	Single, anthracite grey	
	T087800	21.517,65	26.897,06	Triple, anthracite grey	
	T409996	990,15	1.237,69	driver LED 25W 24Vdc (see the online catalogue for more info)	
	T409998	1.364,48	1.705,59	driver LED 60W 24Vdc (see the online catalogue for more info)	
	T409999	1.799,18	2.248,97	driver LED 90W 24Vdc (see the online catalogue for more info)	
 <p>SE ES FLOOR Carolina Gismondi dB, Daniele Moioli Outdoor floor lamp</p> <p>IP 67 LED 3000K, 33W, 1200lm, CRI=90 Dimmable (Push & APP)</p> <p>Materials: steel, aluminum, optical silicone</p>	T070410	17.919,30	22.399,13	mirrored	NEW
 <p>SE ES FLOOR 180 Carolina Gismondi dB, Daniele Moioli Outdoor floor lamp</p> <p>IP 67 LED 3000K, 33W, 1200lm, CRI=90 Dimmable (Push & APP)</p> <p>Materials: steel, aluminum, optical silicone</p>	T070510	19.899,60	24.874,50	mirrored	NEW
 <p>SE ES SUSPENSION Carolina Gismondi dB, Daniele Moioli Outdoor floor lamp</p> <p>IP 67 LED 3000K, 33W, 1200lm, CRI=90 Dimmable (Push & APP)</p> <p>Materials: steel, aluminum, optical silicone</p>	T070310	18.402,30	23.002,88	mirrored	NEW

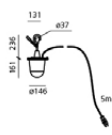

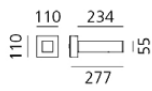
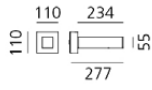
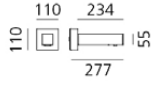
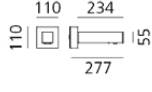
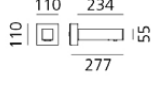
ARTEMIDE OUTDOOR

	Code	Veil Pris NOK eks mva	Veil Pris NOK ink mva	
 <p>SLICING SUSPENSION 21 BIG Outdoor floor lamp IP 65 LED 3000K, 14W, 418lm, CRI=90 Materials: aluminum, steel</p>	T250310	12.062,93	15.078,66	
 <p>SLICING SUSPENSION 42 BIG Outdoor suspension fixture IP 65 LED 3000k, 30W, 1600lm, CRI=90 Materials: aluminum, steel</p>	T250410	18.535,13	23.168,91	
 <p>SLICING SUSPENSION 63 BIG Outdoor suspension fixture IP 65 LED 3000K, 28W, 2149lm, CRI=90 Materials: aluminum, steel</p>	T250510	22.640,63	28.300,78	
 <p>SLICING WALL/CEILING BIG Outdoor wall fixture IP 65 LED 3000K, 14W, 207lm, CRI=90 Materials: aluminum, steel</p>	T250610	6.713,70	8.392,13	
 <p>SLICING BOLLARD BIG Outdoor wall fixture IP 65 LED 3000K, 20W, 580lm, CRI=90 Materials: aluminum, steel</p>	T250110	22.640,63	28.300,78	
 <p>SLICING STEM BIG Outdoor wall fixture IP 65 LED 3000K, 20W, 521lm, CRI=90 Materials: aluminum, steel</p>	T250210	14.550,38	18.187,97	
 <p>TETRAGONO WALL Ernesto Gismondi Wall fixture IP 65 LED 3000K, 15W, 481lm, CRI=90 with electronic ballast Materials: aluminum, polycarbonate</p>	T417100W00	7.088,03	8.860,03	anthracite grey

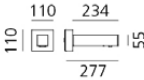

ARTEMIDE OUTDOOR

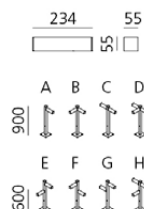
	<p>TETRAGONO 45 FLOOR Ernesto Gismondi Outdoor floor lamp</p> <p>IP 65 LED 3000K, 15W, 481lm, CRI=90 with electronic ballast</p> <p>Materials: aluminum, polycarbonate</p>	T417200W00	7.836,68	9.795,84	anthracite grey base flange included
	<p>TETRAGONO 90 FLOOR Ernesto Gismondi Outdoor floor lamp</p> <p>IP 65 LED 3000K, 15W, 481lm, CRI=90 with electronic ballast</p> <p>Materials: aluminum, polycarbonate</p>	T417300W00	6.653,33	8.316,66	anthracite grey base flange included
	<p>TOLOMEO PARALUME OUTDOOR FLOOR Michele De Lucchi, Giancarlo Fassina Outdoor floor lamp</p> <p>IP 44 LED 3000K, 20W, 1673lm/1022lm/858lm, CRI=90</p> <p>Materials: aluminum, steel</p>	T076150 T076300 T077330 T077340 T077350	8.090,25 6.399,75 3.851,93 3.851,93 3.851,93	10.112,81 7.999,69 4.814,91 4.814,91 4.814,91	body lamp aluminium base+stem spun fabric white diffuser Ø 520mm weaved fabric dove grey diffuser Ø 520mm weaved fabric black diffuser Ø 520mm Complete lamp consists of 3 items.
	<p>TOLOMEO PARALUME OUTDOOR SUSPENSION Michele De Lucchi, Giancarlo Fassina Outdoor suspension fixture</p> <p>IP 65 LED 3000K, 20W, 1673lm/1022lm/858lm, CRI=90</p> <p>Materials: aluminum, steel</p>	T076050 T077330 T077340 T077350	5.409,60 3.851,93 3.851,93 3.851,93	6.762,00 4.814,91 4.814,91 4.814,91	body lamp spun fabric white diffuser Ø 520mm weaved fabric dove grey diffuser Ø 520mm weaved fabric black diffuser Ø 520mm Complete lamp consists of 2 items.
	<p>TOLOMEO PARALUME OUTDOOR HOOK Michele De Lucchi, Giancarlo Fassina Outdoor hook fixture</p> <p>IP 44 LED 3000K, 20W, 1673lm/1022lm/858lm, CRI=90</p> <p>Materials: aluminum, steel</p>	T076550 T077330 T077340 T077350	5.409,60 3.851,93 3.851,93 3.851,93	6.762,00 4.814,91 4.814,91 4.814,91	hook structure spun fabric white diffuser Ø 520mm weaved fabric dove grey diffuser Ø 520mm weaved fabric black diffuser Ø 520mm Complete lamp consists of 2 items.
	<p>TOLOMEO LAMPIONE OUTDOOR FLOOR Michele De Lucchi, Giancarlo Fassina Outdoor floor lamp</p> <p>IP 44 LED 3000K, 20W, 2034lm, CRI=90</p> <p>Materials: aluminum, steel</p>	T078150 T076300	8.090,25 6.399,75	10.112,81 7.999,69	body lamp base+stem Complete lamp consists of 2 items.
	<p>TOLOMEO LAMPIONE OUTDOOR SUSPENSION Michele De Lucchi, Giancarlo Fassina Outdoor suspension fixture</p> <p>IP 65 LED 3000K, 20W, 2034lm, CRI=90</p> <p>Materials: aluminum, steel</p>	T078050	5.409,60	6.762,00	aluminium

ARTEMIDE OUTDOOR

		Code	Veil Pris NOK eks mva	Veil Pris NOK ink mva		
 <p>TOLOMEO LAMPIONE OUTDOOR HOOK Michele De Lucchi, Giancarlo Fassina Outdoor hook fixture</p> <p>IP 44 LED 3000K, 20W, 2034lm, CRI=90</p> <p>Materials: aluminum, steel</p>		T078550	5.409,60	6.762,00	aluminium	
 <p>TOLOMEO XXL LED OUTDOOR Michele De Lucchi, Giancarlo Fassina Outdoor floor lamp</p> <p>IP 65 LED 3000K, 55W, 5052lm, CRI=80</p> <p>Materials: aluminum, technopolymer, concrete, steel inox</p>		1532150A	116.161,50	145.201,88	LED: body lamp with base	
			1535150A	105.402,68	131.753,34	LED: body lamp with fixed earth support
 <p>WALKING WALL SYMMETRIC EMISSION - functional light Carlotta de Bevilacqua Outdoor wall fixture</p> <p>IP 65 LED 3000K, 10W, 328lm, CRI=90</p> <p>Materials: aluminum, glass</p>		T4503SM020	4.540,20	5.675,25	grey/white RAL 9002	
			T4503SM050	4.540,20	5.675,25	blue
 <p>WALKING WALL ASYMMETRIC EMISSION - functional light Carlotta de Bevilacqua Outdoor wall fixture</p> <p>IP 65 LED 3000K, 10W, 443lm, CRI=90</p> <p>Materials: aluminum, glass</p>		T4503AS020	4.854,15	6.067,69	grey/white RAL 9002	
			T4503AS030	4.854,15	6.067,69	black
			T4503AS040	4.854,15	6.067,69	red
			T4503AS050	4.974,90	6.218,63	blue
			T4503AS060	4.854,15	6.067,69	yellow
 <p>WALKING WALL RED - light signs Carlotta de Bevilacqua Outdoor wall fixture</p> <p>IP 65 LED 3000K, 4W, red light</p> <p>Materials: aluminum, glass</p>		T4503LR020	4.974,90	6.218,63	grey/white RAL 9002	
			T4503LR030	4.974,90	6.218,63	black
			T4503LR040	4.974,90	6.218,63	red
			T4503LR050	4.974,90	6.218,63	blue
			T4503LR060	4.974,90	6.218,63	yellow
 <p>WALKING WALL GREEN - light signs Carlotta de Bevilacqua Outdoor wall fixture</p> <p>IP 65 LED 3000K, 4W, green light</p> <p>Materials: aluminum, glass</p>		T4503LG020	4.974,90	6.218,63	grey/white RAL 9002	
			T4503LG030	4.974,90	6.218,63	black
			T4503LG040	4.974,90	6.218,63	red
			T4503LG050	4.974,90	6.218,63	blue
			T4503LG060	4.974,90	6.218,63	yellow
 <p>WALKING WALL BLUE - light signs Carlotta de Bevilacqua Outdoor wall fixture</p> <p>IP 65 LED 3000K, 4W, blue light</p> <p>Materials: aluminum, glass</p>		T4503LB020	4.974,90	6.218,63	grey/white RAL 9002	
			T4503LB030	4.974,90	6.218,63	black
			T4503LB040	4.974,90	6.218,63	red
			T4503LB050	4.974,90	6.218,63	blue
			T4503LB060	4.974,90	6.218,63	yellow

ARTEMIDE OUTDOOR

ARTEMIDE OUTDOOR				
 <p>WALKING WALL WHITE - light signs Carlotta de Bevilacqua Outdoor wall fixture</p> <p>IP 65 LED 3000K, 4W, white light, CRI=80</p> <p>Materials: aluminum, glass</p>	T4503LW020	4.974,90	6.218,63	grey/white RAL 9002
	T4503LW030	4.974,90	6.218,63	black
	T4503LW040	4.974,90	6.218,63	red
	T4503LW050	4.974,90	6.218,63	blue
	T4503LW060	4.974,90	6.218,63	giallo
 <p>WALKING POLE 600 Carlotta de Bevilacqua Pole outdoor fixture</p> <p>IP 65 symmetric emission: LED 3000K, 10W, 328lm, CRI=90</p> <p>asymmetric emission: LED 3000K, 10W, 443lm, CRI=90</p> <p>red light emission: LED 3000K, 4W, red light</p> <p>green light emission: LED 3000K, 4W, green light</p> <p>blue light emission: LED 3000K, 4W, blue light</p> <p>white light emission: LED 3000K, 4W, white light, CRI=80</p> <p>Materials: aluminum, glass</p>	T4501SM020	3.984,75	4.980,94	head pole symmetric emission: grey/white RAL 9002
	T4501SM030	3.984,75	4.980,94	head pole symmetric emission: black
	T4501SM040	4.105,50	5.131,88	head pole symmetric emission: red
	T4501SM050	4.105,50	5.131,88	head pole symmetric emission: blue
	T4501SM060	4.105,50	5.131,88	head pole symmetric emission: yellow
	T4501AS020	3.984,75	4.980,94	head pole asymmetric emission: grey/white RAL 9002
	T4501AS030	4.105,50	5.131,88	head pole asymmetric emission: black
	T4501AS040	4.105,50	5.131,88	head pole asymmetric emission: red
	T4501AS050	3.984,75	4.980,94	head pole asymmetric emission: blue
	T4501AS060	3.984,75	4.980,94	head pole asymmetric emission: yellow
	T4501LR020	4.419,45	5.524,31	head pole/red light: grey/white RAL 9002
	T4501LR030	4.419,45	5.524,31	head pole/red light: black
	T4501LR040	4.419,45	5.524,31	head pole/red light: red
	T4501LR050	4.419,45	5.524,31	head pole/red light: blue
	T4501LR060	4.419,45	5.524,31	head pole/red light: yellow
	T4501LG020	4.419,45	5.524,31	head pole/green light: grey/white RAL 9002
	T4501LG030	4.419,45	5.524,31	head pole/green light: black
	T4501LG040	4.419,45	5.524,31	head pole/green light: red
	T4501LG050	4.419,45	5.524,31	head pole/green light: blue
	T4501LG060	4.419,45	5.524,31	head pole/green light: yellow
	T4501LB020	4.419,45	5.524,31	head pole/blue light: grey/white RAL 9002
	T4501LB030	4.419,45	5.524,31	head pole/blue light: black
	T4501LB040	4.419,45	5.524,31	head pole/blue light: red
	T4501LB050	4.419,45	5.524,31	head pole/blue light: blue
	T4501LB060	4.419,45	5.524,31	head pole/blue light: yellow
	T4501LW020	4.419,45	5.524,31	head pole/white light: grey/white RAL 9002
	T4501LW030	4.419,45	5.524,31	head pole/white light: black
	T4501LW040	4.419,45	5.524,31	head pole/white light: red
	T4501LW050	4.419,45	5.524,31	head pole/white light: blue
	T4501LW060	4.419,45	5.524,31	head pole/white light: yellow
	T4505A30	4.286,63	5.358,28	A: pole H.60cm x 1 head
	T4505B30	5.530,35	6.912,94	B: pole H.60cm x 2x90° heads
T4505C30	5.530,35	6.912,94	C: pole H.60cm x 2x180° heads	
T4505D30	5.663,18	7.078,97	D: pole H.60cm x 3x270° heads	

ARTEMIDE OUTDOOR

WALKING POLE 900

 Carlotta de Bevilacqua
 Pole outdoor fixture

IP 65

 symmetric emission:
LED 3000K, 10W, 328lm, CRI=90

 asymmetric emission:
LED 3000K, 10W, 443lm, CRI=90

 red light emission:
LED 3000K, 4W, red light

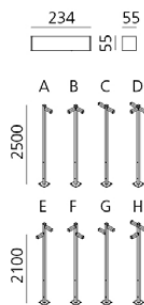
 green light emission:
LED 3000K, 4W, green light

 blue light emission:
LED 3000K, 4W, blue light

 white light emission:
LED 3000K, 4W, white light, CRI=80

Materials: aluminum, glass

T4501SM020	3.984,75	4.980,94	head pole symmetric emission: grey/white RAL 9002
T4501SM030	3.984,75	4.980,94	head pole symmetric emission: black
T4501SM040	4.105,50	5.131,88	head pole symmetric emission: red
T4501SM050	4.105,50	5.131,88	head pole symmetric emission: blue
T4501SM060	4.105,50	5.131,88	head pole symmetric emission: yellow
T4501AS020	3.984,75	4.980,94	head pole asymmetric emission: grey/white RAL 9002
T4501AS030	4.105,50	5.131,88	head pole asymmetric emission: black
T4501AS040	4.105,50	5.131,88	head pole asymmetric emission: red
T4501AS050	3.984,75	4.980,94	head pole asymmetric emission: blue
T4501AS060	3.984,75	4.980,94	head pole asymmetric emission: yellow
T4501LR020	4.419,45	5.524,31	head pole/red light: grey/white RAL 9002
T4501LR030	4.419,45	5.524,31	head pole/red light: black
T4501LR040	4.419,45	5.524,31	head pole/red light: red
T4501LR050	4.419,45	5.524,31	head pole/red light: blue
T4501LR060	4.419,45	5.524,31	head pole/red light: yellow
T4501LG020	4.419,45	5.524,31	head pole/green light: grey/white RAL 9002
T4501LG030	4.419,45	5.524,31	head pole/green light: black
T4501LG040	4.419,45	5.524,31	head pole/green light: red
T4501LG050	4.419,45	5.524,31	head pole/green light: blue
T4501LG060	4.419,45	5.524,31	head pole/green light: yellow
T4501LB020	4.419,45	5.524,31	head pole/blue light: grey/white RAL 9002
T4501LB030	4.419,45	5.524,31	head pole/blue light: black
T4501LB040	4.419,45	5.524,31	head pole/blue light: red
T4501LB050	4.419,45	5.524,31	head pole/blue light: blue
T4501LB060	4.419,45	5.524,31	head pole/blue light: yellow
T4501LW020	4.419,45	5.524,31	head pole/white light: grey/white RAL 9002
T4501LW030	4.419,45	5.524,31	head pole/white light: black
T4501LW040	4.419,45	5.524,31	head pole/white light: red
T4501LW050	4.419,45	5.524,31	head pole/white light: blue
T4501LW060	4.419,45	5.524,31	head pole/white light: yellow
T4506A30	5.409,60	6.762,00	A: pole H.90cm x 1 head
T4506B30	5.904,68	7.380,84	B: pole H.90cm x 2x90° heads
T4506C30	5.904,68	7.380,84	C: pole H.90cm x 2x180° heads
T4506D30	5.904,68	7.380,84	D: pole H.90cm x 3x180° heads
T4506E30	5.904,68	7.380,84	E: pole H.90cm +60cm x 2x90° heads
T4506F30	5.904,68	7.380,84	F: pole H.60cm +90cm x 2x90° heads
T4506G30	5.904,68	7.380,84	G: pole H.90cm + 60cm x 2x180° heads
T4506H30	6.158,25	7.697,81	H: pole H.60cm + 90cm x 3x180° heads

ARTEMIDE OUTDOOR

WALKING POLE 2500

 Carlotta de Bevilacqua
 Pole outdoor fixture

IP 65

 symmetric emission:
LED 3000K, 10W, 328lm, CRI=90

 asymmetric emission:
LED 3000K, 10W, 443lm, CRI=90

 red light emission:
LED 3000K, 4W, red light

 green light emission:
LED 3000K, 4W, green light

 blue light emission:
LED 3000K, 4W, blue light

 white light emission:
LED 3000K, 4W, white light, CRI=80

Materials: aluminum, glass

Code	Veil Pris NOK eks mva	Veil Pris NOK ink mva	
T4501SM020	3.984,75	4.980,94	head pole symmetric emission: grey/white RAL 9002
T4501SM030	3.984,75	4.980,94	head pole symmetric emission: black
T4501SM040	4.105,50	5.131,88	head pole symmetric emission: red
T4501SM050	4.105,50	5.131,88	head pole symmetric emission: blue
T4501SM060	4.105,50	5.131,88	head pole symmetric emission: yellow
T4501AS020	3.984,75	4.980,94	head pole asymmetric emission: grey/white RAL 9002
T4501AS030	4.105,50	5.131,88	head pole asymmetric emission: black
T4501AS040	4.105,50	5.131,88	head pole asymmetric emission: red
T4501AS050	3.984,75	4.980,94	head pole asymmetric emission: blue
T4501AS060	3.984,75	4.980,94	head pole asymmetric emission: yellow
T4501LR020	4.419,45	5.524,31	head pole/red light: grey/white RAL 9002
T4501LR030	4.419,45	5.524,31	head pole/red light: black
T4501LR040	4.419,45	5.524,31	head pole/red light: red
T4501LR050	4.419,45	5.524,31	head pole/red light: blue
T4501LR060	4.419,45	5.524,31	head pole/red light: yellow
T4501LG020	4.419,45	5.524,31	head pole/green light: grey/white RAL 9002
T4501LG030	4.419,45	5.524,31	head pole/green light: black
T4501LG040	4.419,45	5.524,31	head pole/green light: red
T4501LG050	4.419,45	5.524,31	head pole/green light: blue
T4501LG060	4.419,45	5.524,31	head pole/green light: yellow
T4501LB020	4.419,45	5.524,31	head pole/blue light: grey/white RAL 9002
T4501LB030	4.419,45	5.524,31	head pole/blue light: black
T4501LB040	4.419,45	5.524,31	head pole/blue light: red
T4501LB050	4.419,45	5.524,31	head pole/blue light: blue
T4501LB060	4.419,45	5.524,31	head pole/blue light: yellow
T4501LW020	4.419,45	5.524,31	head pole/white light: grey/white RAL 9002
T4501LW030	4.419,45	5.524,31	head pole/white light: black
T4501LW040	4.419,45	5.524,31	head pole/white light: red
T4501LW050	4.419,45	5.524,31	head pole/white light: blue
T4501LW060	4.419,45	5.524,31	head pole/white light: yellow
T4507A30	7.643,48	9.554,34	A: pole H.250cm x 1 head
T4507B30	8.271,38	10.339,22	B: pole H.250cm x 2x90° heads
T4507C30	8.271,38	10.339,22	C: pole H.250cm x 2x180° heads
T4507D30	8.271,38	10.339,22	D: pole H.250cm x 3x180° heads
T4507E30	8.271,38	10.339,22	E: pole H.250cm + 210cm x 2x90° heads
T4507F30	8.271,38	10.339,22	F: pole H.210cm + 250cm x 2x90° heads
T4507G30	8.271,38	10.339,22	G: pole H.250cm + 210cm x 2x180° heads
T4507H30	8.392,13	10.490,16	H: pole H.210cm + 250cm x 3x180° heads



Lighting Solutions

NORLUX AS
Borgeskogen 32
3160 Stokke
Norway

Tel. +47 33 30 10 80
post@norlux.com
www.norlux.com



Artemide®

www.artemide.com

