



FDV SPEC SHEET

Zeta Mini

Art. no: 1017-7-15-2



Lighting Solutions

 155mm

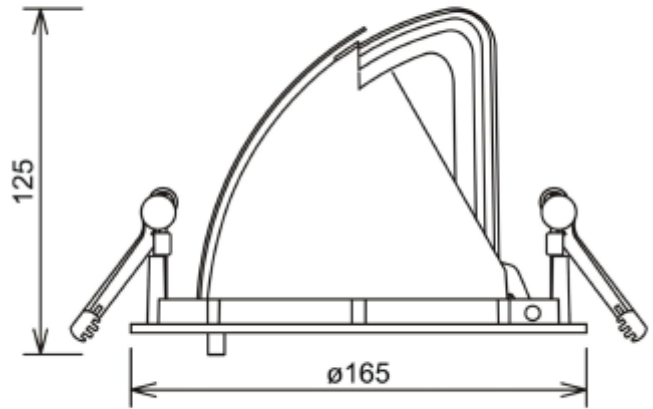

Zeta Mini



Art. no: 1017-7-15-2

LIGHT TECHNICAL

Lightsource Type:	LED (built in)
Lumen Output:	3031
Lumen LED (tc=25):	4050
Beam Angle:	15°
CCT (Color Temperature):	2700
CRI / Ra:	80
Color Code:	827
MacAdam (SDCM):	3
Lens (Diffuser):	Clear

MOUNTING / CONNECTION

Connection:	18i3 Quick connection
Cut-out [mm]:	Ø155
Mounting:	Recessed, Ceiling

ELECTRICAL DATA

Dimming:	None
System Power [W]:	27
System Voltage [V]:	230V 50Hz
Protection Class:	2
Max load pr circuit - B10:	14
Max load pr circuit - B16:	24
Max load pr circuit - C10:	24
Max load pr circuit - C16:	40
Inrush current I _{max} [A]:	25
Inrush current time [µs]:	150
Current Output [mA]:	700
Voltage Forward Min [V]:	30,6
Voltage Forward Max [V]:	39,2



FDV SPEC SHEET

Zeta Mini

Art. no: 1017-7-15-2



Lighting Solutions

PRODUCT

To be recessed in insulation:	No
Ingress Protection:	IP20
Lifetime [h]:	L80B10: 100 000
Color:	Black
Length [mm]:	165
Height [mm]:	125
Width [mm]:	165
Weight [kg]:	0,95