



FDV SPEC SHEET

Trunk

Art. no: CFL-1550-30NR-08-3



Lighting Solutions

Unit: mm

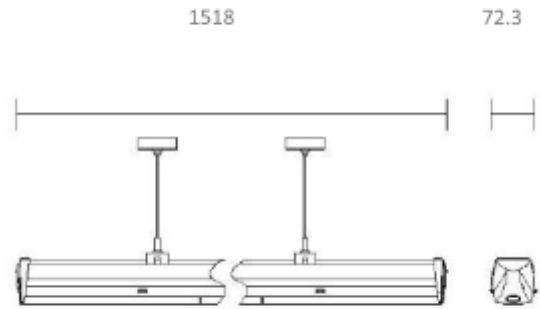

Trunk



Art. no: CFL-1550-30NR-08-

LIGHT TECHNICAL

Lightsource Type:	LED (built in)
Lumen Output:	7763
Lumen LED (tc=25):	7800
Beam Angle:	60°
CCT (Color Temperature):	3000
CRI / Ra:	80
Color Code:	830
Lens (Diffuser):	Clear

MOUNTING / CONNECTION

Connection:	Trunk 8-wires
Mounting:	Suspended, Ceiling

ELECTRICAL DATA

Dimming:	None
System Power [W]:	50
System Voltage [V]:	230V 50Hz
Protection Class:	1
Max load pr circuit - B10:	11
Max load pr circuit - B16:	18
Max load pr circuit - C10:	18
Max load pr circuit - C16:	30
Leakage current [mA]:	0,45
Inrush current I _{max} [A]:	28
Inrush current time [µs]:	280
Current Output [mA]:	70
Voltage Forward Min [V]:	2,8
Voltage Forward Max [V]:	3,3



FDV SPEC SHEET

Trunk

Art. no: CFL-1550-30NR-08-3



Lighting Solutions

PRODUCT

Ingress Protection:	IP20
Lifetime [h]:	L80B10: 100 000
Color:	White
RAL:	RAL9016
Length [mm]:	1500
Height [mm]:	78,6
Width [mm]:	72,3
Weight [kg]:	1,64