



FDV SPEC SHEET

Trunk

Art. no: CFL-1550-40WD-08-3



Lighting Solutions

Unit: mm

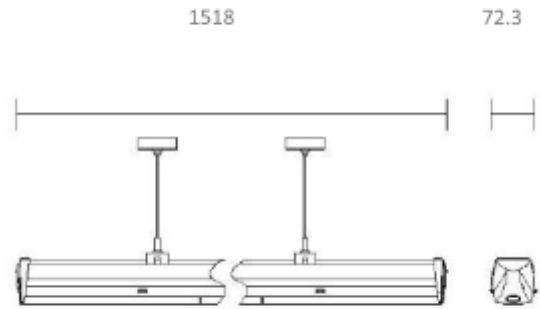

Trunk



Art. no: CFL-1550-40WD-08

LIGHT TECHNICAL

| | |
|--------------------------|----------------|
| Lightsource Type: | LED (built in) |
| Lumen Output: | 8116 |
| Lumen LED (tc=25): | 8500 |
| Beam Angle: | 90° |
| CCT (Color Temperature): | 4000 |
| CRI / Ra: | 80 |
| Color Code: | 840 |
| Lens (Diffuser): | Clear |

MOUNTING / CONNECTION

| | |
|-------------|--------------------|
| Connection: | Trunk 8-wires |
| Mounting: | Suspended, Ceiling |

ELECTRICAL DATA

| | |
|--------------------------------------|-----------|
| System Power [W]: | 50 |
| System Voltage [V]: | 230V 50Hz |
| Protection Class: | 1 |
| Max load pr circuit - B10: | 11 |
| Max load pr circuit - B16: | 18 |
| Max load pr circuit - C10: | 18 |
| Max load pr circuit - C16: | 30 |
| Leakage current [mA]: | 0,45 |
| Inrush current I _{max} [A]: | 28 |
| Inrush current time [µs]: | 280 |
| Current Output [mA]: | 70 |
| Voltage Forward Min [V]: | 2,8 |
| Voltage Forward Max [V]: | 3,3 |



FDV SPEC SHEET

Trunk

Art. no: CFL-1550-40WD-08-3



Lighting Solutions

PRODUCT

| | |
|---------------------|-----------------|
| Ingress Protection: | IP20 |
| Lifetime [h]: | L80B10: 100 000 |
| Color: | White |
| RAL: | RAL9016 |
| Length [mm]: | 1500 |
| Height [mm]: | 78,6 |
| Width [mm]: | 72,3 |
| Weight [kg]: | 1,64 |