



FDV SPEC SHEET

Trunk

Art. no: CFL-2-1570-E-30NRB-08-3



Lighting Solutions

Unit: mm

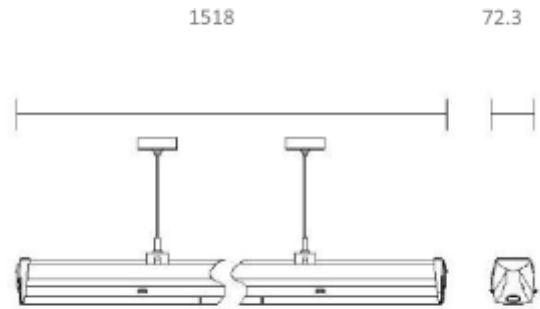

Trunk



Art. no: CFL-2-1570-E-30NR

LIGHT TECHNICAL

Lightsource Type:	LED (built in)
Lumen LED (tc=25):	11000
Beam Angle:	660°
CCT (Color Temperature):	3000
CRI / Ra:	80
Color Code:	830
Lens (Diffuser):	Clear

MOUNTING / CONNECTION

Connection:	Trunk 8-wires
Mounting:	Suspended, Ceiling

ELECTRICAL DATA

Dimming:	None
Flickerfree:	Yes
System Power [W]:	70
System Voltage [V]:	230V 50Hz
Protection Class:	1
Emergency light [h]:	3 hours
Emergency lumen out [lm]:	960



FDV SPEC SHEET

Trunk

Art. no: CFL-2-1570-E-30NRB-08-3



Lighting Solutions

PRODUCT

Ingress Protection:	IP20
Lifetime [h]:	L80B10: 100 000
Color:	White
RAL:	RAL9016
Length [mm]:	1500
Height [mm]:	78,6
Width [mm]:	72,3
Weight [kg]:	3,41