



FDV SPEC SHEET

Celestial Plafond

Art. no: 101570-120-3-p



Lighting Solutions

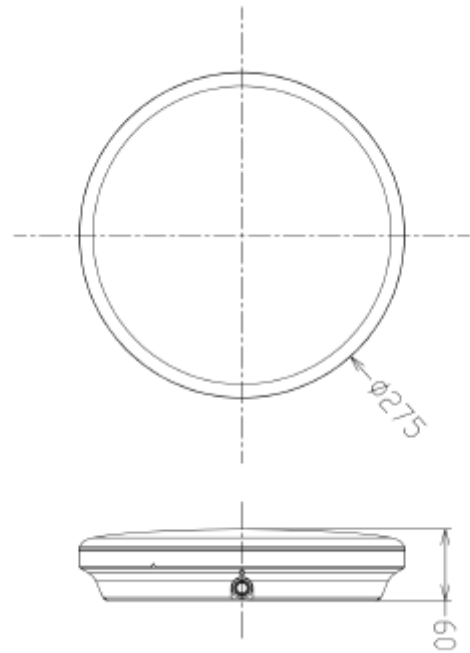

Celestial Plafond

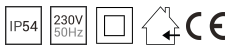

Art. no: 101570-120-3-p

LIGHT TECHNICAL

Lightsource Type:	LED (built in)
Lumen Output:	1350
Lumen LED (tc=25):	1500
Beam Angle:	120°
CCT (Color Temperature):	2700-3000K
CRI / Ra:	80
MacAdam (SDCM):	3
Lens (Diffuser):	Opal

MOUNTING / CONNECTION

Connection:	QuickConnect
Mounting:	Wall, Ceiling

ELECTRICAL DATA

Dimming:	Phase-Cut
Dimming Output Type:	PWM
Dimming Phasecut Type:	Leading / Trailing edge
Standby power P _{sb} (W) <:	0,5
Flicker metric (P _{st} LM) <:	1
Stroboscopic effect metric (SVM) <	0,4
System Power [W]:	12
System Voltage [V]:	230V 50Hz
Protection Class:	2
Max load pr circuit - C10:	107
Max load pr circuit - C16:	172
Leakage current [mA]:	0,75
Inrush current I _{max} [A]:	3,2
Inrush current time [µs]:	40
Current Output [mA]:	140



FDV SPEC SHEET

Celestial Plafond

Art. no: 101570-120-3-p



Lighting Solutions

PRODUCT

Ingress Protection:	IP54
Impact Protection:	IK06
Operating Temperature [°C]:	-20 - 45
Lifetime [h]:	L80B10: 100 000
Color:	White
RAL:	RAL9016
Height [mm]:	60
Width [mm]:	275
Weight [kg]:	0,75
Housing Material :	Polycarbonate
Diffuser Material:	Polycarbonate