



PRODUCT SHEET

Rod Midi C

Art. no: 102310-30-3



Lighting Solutions

Rod Midi C

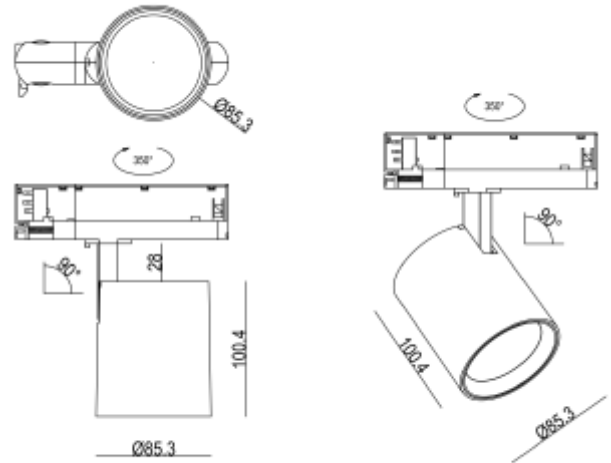

SPECIFICATIONS

Lightsource Type:	LED (built in)
System Power [W]:	23W
CCT (Color Temperature):	3000K
CRI / Ra:	90
Lumen Output:	3150lm
Lumen LED (tc=25):	4100lm
Beam Angle:	30°
Lens (Diffuser):	Clear
Dimming:	None
System Voltage [V]:	230V 50Hz
Connection:	Track 3-Circuit
Mounting:	Track, Ceiling
Lifetime [h]:	L80B10: 100 000h
Lumen/W:	137lm/W
MacAdam (SDCM):	3
Color:	White
Height [mm]:	101mm
Diameter [mm]:	86mm
Weight [kg]:	0,63kg

