



FDV SPEC SHEET

Rod Mini C

Art. no: 102531-20-3



Lighting Solutions

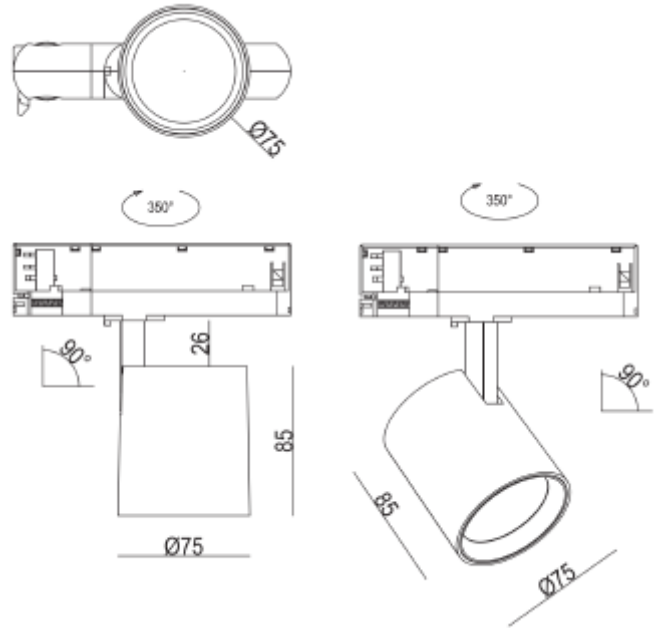

Rod Mini C



Art. no: 102531-20-3

LIGHT TECHNICAL

Lightsource Type:	LED (built in)
Lumen Output:	1800
Lumen LED (tc=25):	2189
Beam Angle:	20
CCT (Color Temperature):	3000
CRI / Ra:	90
Color Code:	930
MacAdam (SDCM):	6
Lens (Diffuser):	Clear

MOUNTING / CONNECTION

Connection:	Track 3-Circuit
Cut-out [mm]:	/

ELECTRICAL DATA

Dimming:	None
Flickerfree:	Yes
System Power [W]:	15
System Voltage [V]:	230V 50Hz
Protection Class:	1
Socket / Cap-Base:	N/A
Current Output [mA]:	350mA
Voltage Forward Min [V]:	33
Voltage Forward Max [V]:	38
Emergency light [h]:	No Emergency light



FDV SPEC SHEET

Rod Mini C

Art. no: 102531-20-3



Lighting Solutions

PRODUCT

Ingress Protection:	IP20
Impact Protection:	IK02
Lifetime [h]:	50 000
Color:	White
RAL:	RAL9010
Height [mm]:	85
Width [mm]:	75
Diameter [mm]:	75
Weight [kg]:	0,485