



PRODUCT SHEET

Rod Mini C

Art. no: 102531-20-3



Lighting Solutions

Rod Mini C

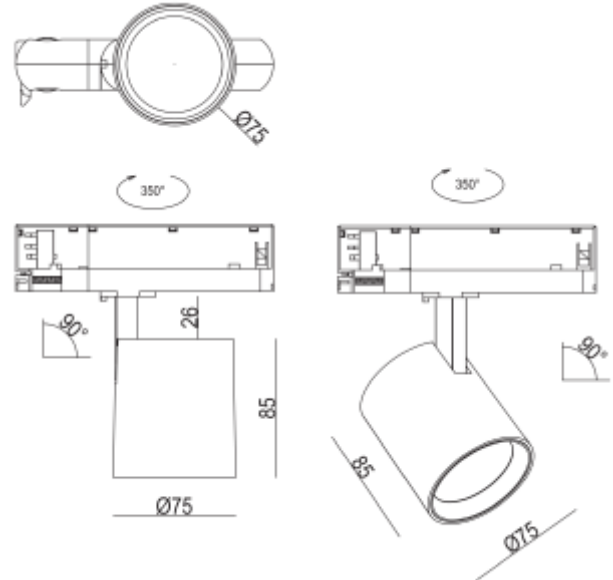

SPECIFICATIONS

Lightsource Type:	LED (built in)
System Power [W]:	15W
CCT (Color Temperature):	3000K
CRI / Ra:	90
Lumen Output:	1800lm
Lumen LED (tc=25):	2189lm
Beam Angle:	20
Lens (Diffuser):	Clear
Dimming:	None
Flickerfree:	Yes
System Voltage [V]:	230V 50Hz
Connection:	Track 3-Circuit
Lifetime [h]:	50 000h
Lumen/W:	120lm/W
MacAdam (SDCM):	6
Color:	White
Height [mm]:	85mm
Width [mm]:	75mm
Diameter [mm]:	75mm
Weight [kg]:	0,485kg
Emergency light [h]:	No Emergency light